

# Outdoor Shower Company, LLC

Dallas, Georgia

www.outdoorshowerco.com — 1-866-SHOWER1

Manufacturers of Quality Outdoor Stainless Steel Showers



ADA METERED VALVE - FREE STANDING COLD WATER: PS-900—PS-1000—PS-1500—PS-1500—BS-2000

## PARTS LIST: PS-900-ADA, PS-1000-ADA, PS-1500-ADA, BS-000-ADA

Accessories may vary due to availability and slight modifications by the manufacturer.

- |                    |   |
|--------------------|---|
| (1) DEL-78         | 2.5 GPM Shower Head   |
| (2) SR-38          | 1/2"x38" Stainless Steel Riser  |
| (3) SV-ADA-665     | 1/2" FPT on/off Straight ADA Compliant Metered Push Valve   |
| (4) SB-40          | 2" X 40" Stainless Steel Base with 6" Base Cover  |
| (5) DF-748-665-ADA | Chrome Plated Brass Bubbler - Stainless Steel Arm—Metered Push Valve  |
| (6) STREET 90-SS   | Stainless Steel 1/2" FIP X 3/8" MIP Street 90   |
| (7) SSTP-6         | 6" Stainless Steel Pipe Threaded Both Ends  |
| (8) FSA-442-ADA    | Foot Shower: 2 1/2 X Close Stainless Steel Nipple, ADA Compliant Metered Angle Valve, 1" Aerating Shower Head |
| (9) HB-158         | 1/2" MIP x 3/4" MHT Chrome Plated Hose Bibb w/Vacuum Breaker  |
| (10) AB-38-MS      | 3 Carbon Steel Drive Anchor Bolts—3/8" X 2-3/8"   |
| (11) BCB-6         | 6" Stainless Steel Base Cylinder with Brackets  |
| (12) PTC-2374      | 3/8" X 3/8" Street 90 Push to Connect   |
| (13) PTC-1264      | 3/8" X 1/2" Push to Connect Adapter Fitting   |
| (14) 3/8 TUBING    | 3/8" OD Polyethalene Tubing   |
| (15) BHS-516       | 5/16" Button Head Socket Head Screws (3)  |



## ADA COMPLIANT METERED PUSH VALVE TIMING

NOTE: If leak occurs at cap gasket, remove gasket and inspect it for damage and replace if necessary. If the gasket is in good condition, inspect the body surface for scratches or nicks and clean up the surface by reaming if necessary.

### TIMING ADJUSTMENT:

These instructions are for the user to adjust the faucet to provide a flow rate to meet the American Disability Act (ADA) regulations which require 10 seconds running time for the water flow. For ADA compliance follow these procedures:

NOTE: Timing must be checked with the handle in place.

A) Purge the valve of air by pushing it completely open 4-8 times rapidly and then check the timing cycle.

B) Remove the handle with a 3/32" hex wrench.

C) Time is changed by rotating plastic serrated adjustment nut with a pair of pliers. Raising nut (counter clockwise) shortens time, lowering nut

D) Once cycle time is satisfactory, lock handle in place making sure set screw is securely fastened on groove in stem. Insert the colored index button.

Tighten the actuator assembly onto the body to approximately 20 ft. lbs., (Hand tighten and give the actuator assembly a 1/2 to 1 full turn with a wrench). **DO NOT OVERTIGHTEN. THIS WILL DAMAGE WASHER AND VALVE WILL NOT SHUT OFF COMPLETELY.**

### HOW TO ADJUST TOP VIEW

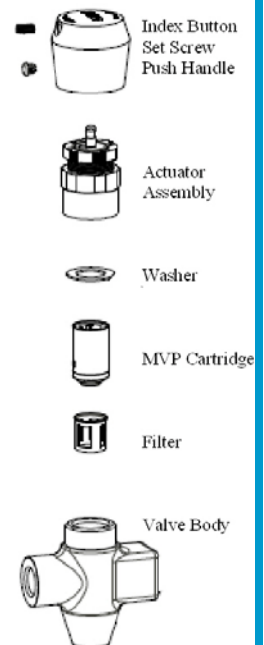
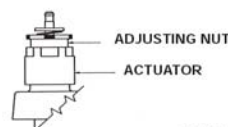



1-866-SHOWER1  
 WWW.OUTDOORSHOWERCO.COM  
 info@outdoorshowerco.com

**PS-900-ADA**  
**PS-1000-ADA**  
**PSDF-1500-ADA**  
**BS-2000-ADA**

- FREE STANDING COLD WATER
- ADA COMPLIANT ADJUSTABLE METERED PUSH VALVE

Shower units can be modified by adding or removing accessories.  
 MODIFICATIONS:

- BS-2000-ADA Less Hose Bibb = Part #BS-2000-ADA-LSHB
- PSDF-1500-ADA Less Hose Bibb = Part #PSDF-1500-ADA LSHB
- PSDF-1500-ADA with Foot Shower = Part #PSDF-1500-ADA-FS

PS-900-ADA    PS-1000-ADA    PSDF-1500-ADA    BS-2000-ADA

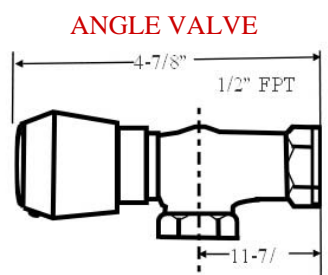
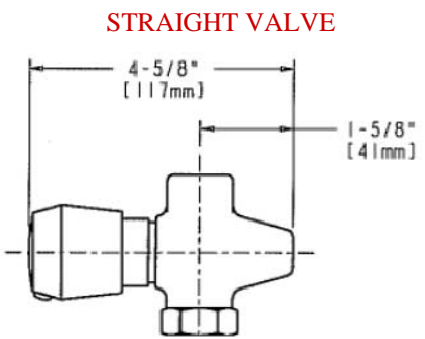
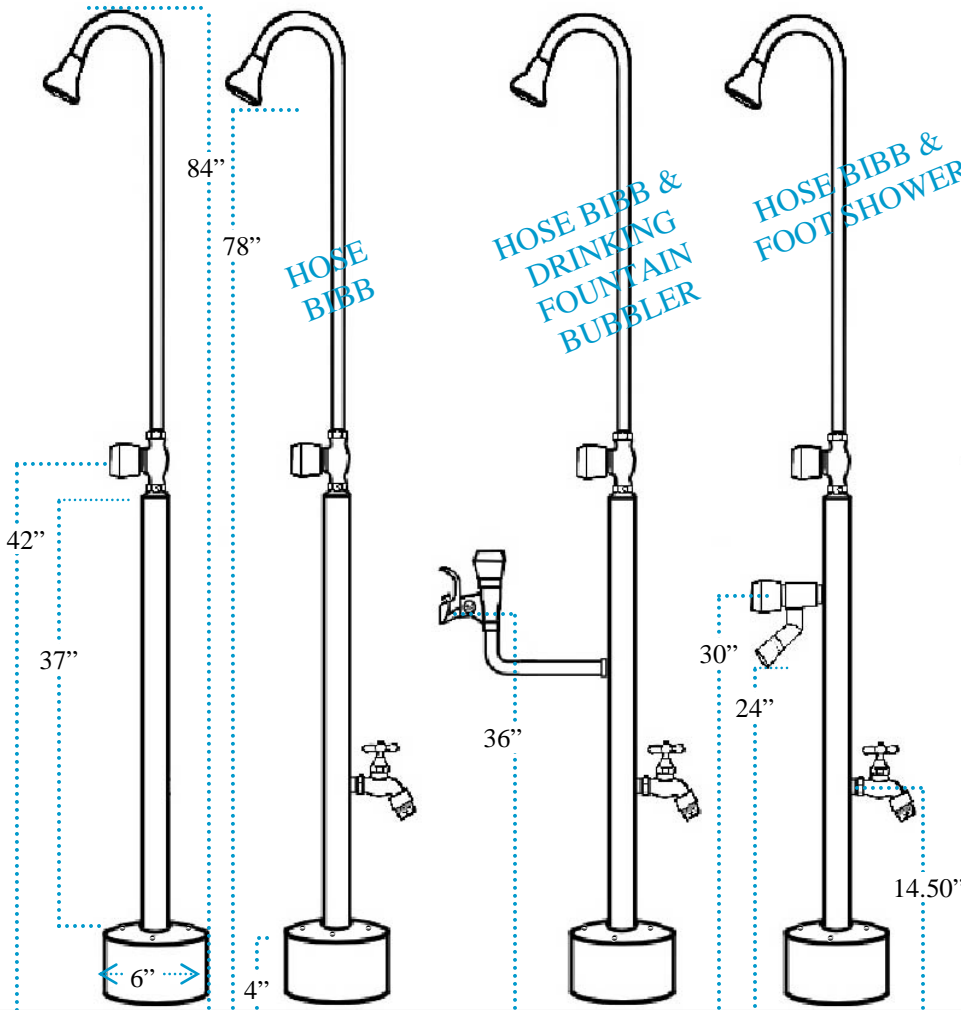

POSITION OF ACCESSORIES CAN VARY WHEN SHOWER BASE IS ROTATED CLOCKWISE OR COUNTERCLOCKWISE. POSITIONS SHOWN IN DRAWINGS IS FOR VIEWING ONLY.

**TECHNICAL DATA:**

- FREE STANDING UNIT
- CHROME PLATEED BRASS ADA SELF-CLOSING AUTO SHUT-OFF METERED PUSH VALVE
- CHROME PLATED BRASS HOSE BIBB WITH VACUUM BREAKER
- 304 STAINLESS STEEL SCH 40 SS 1/2" X 38" RISER
- 304 STAINLESS STEEL TUBING 2" X 40" BASE
- 304 STAINLESS STEEL BASE CYLINDER & COVER
- 3/8 x 2-3/8 CARBON STEEL DRIVE ANCHOR BOLTS
- 2.5 GPM CHROME PLATED BRASS SHOWER HEAD
- CHROME PLATED BRASS DRINKING FOUNTAIN BUBBLER
- ASME A112.18.1 COMPLIANT
- CSA B125 COMPLIANT
- CSA B 64.2 COMPLIANT
- ANSI/NSF Std. 61-1999a

# **FREE STANDING COLD WATER SHOWER BASE INSTALLATION**

1-866-SHOWER1  
 WWW.OUTDOORSHOWERCO.COM  
 info@outdoorshowerco.com



**FREE STANDING COLD WATER INSTALLATION**

You will need: 9/16" wrench and crescent wrench, Hammer, Roto Hammer - 3/8" drill bit, Teflon tape

**Flush lines before installing valves and shower head. Debris in water line can cause valves to malfunction.**

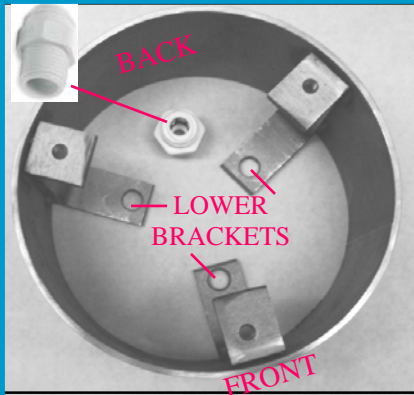

1. Run a 1/2" water supply line to the desired location of the shower unit. Cut off as close as possible to flooring surface.
2. Attach 1/2" water supply line to 1/2" x 3/8" Union approximately 1" off center of
3. Using Lower Bracket pre-drilled holes of the Base Cylinder as a guide, mark the placement of the drill holes at desired location of installation. Drill 3, 3/8" holes, 3" deep.

9. Attach straight valve to lower portion of shower unit, and attach riser to valve using Teflon Tape.



10. Attach any accessories to base using Teflon Tape. Tape is not needed for the Shower Head.



4. Attach Elbows and Adapters to Hose. Attach one end to water supply line coming out of the ground.



5. Position Base Cylinder to line up with pre-drilled holes in flooring surface. Insert Anchor Bolts in each hole. When bolts are in position hit the pin of the bolt with a hammer, locking it into place. Tighten nuts.

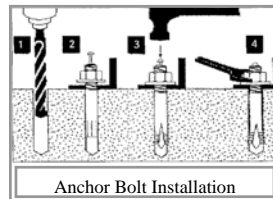

6. Lay Shower Base and Cover Plate on Base Cylinder and attach other end of hose to opening on underside.

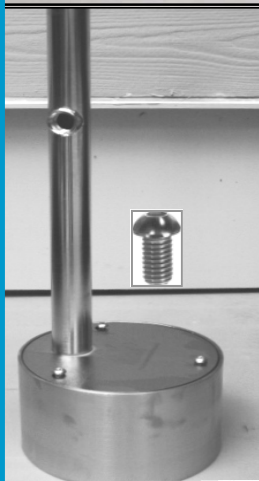

7. Curl hose inside Base Cylinder and place Base Plate on top, lining up with the 3 pre-drilled holes.

8. Stand shower base in upright position and attach Base Plate to Base Cylinder using button head cap screws.

- BS-2000-ADA Shower Unit
- Metered Push Valves
  - Foot Shower
  - Hose Bibb

Foot Shower



Hose Bibb



ADA Compliant Metered Drinking Fountain Accessory



## **WINTERIZATION**

It is recommended that a shut off valve be installed in the supply line going to the shower unit for winterization. To prevent freeze damage remove and store shower unit leaving Base Cylinder anchored to flooring surface. If the shower unit is left outdoors cut off water supply, completely drain or blow out all moisture, and remove all accessories and valves.

To disconnect hose from push-to-connect adapters push Release Collar in toward support sleeve.

**FREEZE DAMAGE IS NOT COVERED BY THE WARRANTY.**



# WARRANTY / RETURN POLICY MAINTENANCE



All items manufactured by Outdoor Shower Company, LLC . are manufactured in Dallas, Georgia, and we guarantee 100% customer satisfaction. Only the finest stainless steel materials are used. Each piece is individually crafted and is electro-polished, which smoothes, polishes, and deburrs the product surface, making it easier to clean and resistant to contamination.

Stainless steel materials come with a ten (10) year limited warranty against defect and workmanship. All accessories not manufactured by Outdoor Shower Company, LLC . are covered by warranty for a period of two (2) year from the receipt by the original purchaser. This warranty will become void if merchandise is damaged, improperly maintained or installed, or modified without the authorization from our licensed distributor.

The warranties include replacement or repair of defective parts and an unconditional guarantee against manufacturing defects. The company will replace or repair at its option any equipment manufactured or supplied as part of our merchandise found to be defective if the conditions are met. Any shipping fees associated with the return or replacement of merchandise covered by this warranty will be incurred by Outdoor Shower Company, LLC . **We reserve the right to determine if damage to a unit or any parts is the direct cause of not complying with manufacturer's guidelines. Special Order non-stock items are NOT returnable.**

**WARNING: FREEZE DAMAGE is NOT covered by the warranty.**

**It is very important to winterize outdoor showers. Just like water faucets and hose bibbs, they are susceptible to freeze damage. The unit(s) must be drained in freezing conditions. In extremely cold temperatures it is advisable to remove faucets and hose bibbs and store them during winter months. Vented plugs are available through Outdoor Shower Company, LLC .**

Although care was taken in the design and manufacture of your new pool shower to ensure it's safe operation, we accept no responsibility for the improper use or installation of equipment, as it is no longer in our control. Buyers have the right of inspection, approval, and acceptance within thirty days of arrival.

We will not be responsible for transportation or labor for items returned for repair or replacement of parts where the merchandise was not properly installed or maintained. An authorized distributor must request a Return Authorization Form from Outdoor Shower Company, LLC and submit it before the return can be approved. A 20% re-stock fee and the cost of shipping will be withheld on returns.

Our Customer Service Department is available for ordering replacement parts or if it should become necessary for you to return your Pool Shower unit. We can also repair or replace damaged parts for a minimal fee. Call **678-363-3939** or **1-866-SHOWER1** for return authorization and instructions, or E-mail us at **info@outdoorshowerco.com**.

Additional information is available at [www.outdoorshowerco.com](http://www.outdoorshowerco.com).

**CAUTION:** Where outdoor temperatures reach more than 90 degrees use caution to prevent burns to skin from scalding water. When a shower unit is connected to an exposed water hose, it is recommended that a light colored hose be used in order to reduce solar gain and keep water temperature inside the hose near the ambient temperature. Water is stored in the body of the shower unit when not in use, and although the patented satin finish on our stainless steel components has minimal solar gain, in warm climates water temperatures inside the hose or shower unit can reach more than 110° which can result in minor burns to delicate skin tissue.

**HOT & COLD SHOWER UNITS:** Some states require Pressure Balancing Valves for hot & cold valves. These are available through any plumbing supply company and can be added to the water supply lines feeding into the shower valve. When hot water is used for bathing it is always recommended that the temperature on the water heater be set at 110° or less in order to prevent the risks of minor burns from scalding water.

Outdoor Shower Company, LLC . does not accept responsibility for bodily injury caused from improper use of its equipment or failure to use caution when operating the shower unit(s). It is recommended that the shower unit(s) be turned on for 30 seconds before contact with water spray in order to avoid accidental scalding and ensure safe use of this product.

Stainless steel does not "rust" as you think of regular steel rusting with a red oxide on the surface that flakes off. If you see red rust it is probably because the product was contaminated, steel or iron scratched the surface, and particles became embedded in the surface. These particles are much less corrosion resistant than the stainless steel and rust, making it appear that the stainless steel is rusting. Stainless steel should never be cleaned with steel wool or an abrasive cleaner. Brillo and S.O.S. pads are made of steel wire. Iron particles from these pads will contaminate the surface. NEVER use an iron-based product on stainless steel. Damp steel or cast iron can be left behind causing the stainless steel to stain (rust). In most cases, light staining can be removed with a fine abrasive cleaner, scouring powder, or non-metallic abrasive scouring pad such as a Scotch Brite® pad. Apply the cleaning product in the same direction as the polish to minimize damage. Stainless Steel cleaner is suggested and can be purchased at most home improvement stores. WD-40 is also an excellent cleaner and polisher of stainless steel. If there are obvious polishing lines rub in the same direction as the grain of the steel to minimize surface finish damage.