

Outdoor Shower Company, LLC

Dallas, Georgia

www.outdoorshowerco.com—1-866-shower1

Manufacturers of Quality Stainless Steel Showers



PARTS LIST: WM-442-CHV & WM-442-ADA

- | | | |
|---|------------|---|
| ① | DEL-78 | 2.5 GPM Chrome Plated Brass Shower Head |
| ② | SR-40 | ½"x 39" 304 sch 40 Stainless Steel Riser TBE |
| ③ | WB-2 | 2" Stainless Steel Wall Bracket & Flange
Stainless Steel Phillips Oval Head Screws (2) - size #8, length: 1-1/2
Stainless Steel Socket Point Type Set Screw Thread Size: 1/4-20 |
| ④ | AV-442-CHV | Chrome Plated Brass Cross Handle Valve - 1/2" NPT (WM-442-CHV) |
| | AV-442-ADA | Chrome Plated Brass Metered Auto Shut-off Push Valve—1/2" NPT (WM-442-ADA) |
| ⑤ | WXF-2 | 2" Diameter Chrome Plated Brass Wall Trim Flange |

Accessories may vary due to availability and slight modifications by the manufacturer.

Installation Guidelines

- Recommended Shower Head Height: 78"
 - Water Supply Line thread should be exposed through wall and roughed in at 40"- 42" from flooring surface.
1. Bring ½" water supply line out of wall with 1" of threads exposed.
 2. Slide mounting bracket onto riser.
 3. Using a level or plumb line, mark placement holes for mounting bracket.
 4. Attach shower riser to angle valve using Teflon tape on threads.
 5. Connect water supply line to angle valve.
 6. Pre-drill previously marked holes for placement of mounting brackets.
 7. Secure unit to wall with stainless steel screws.
 8. Tighten set screw on ring bracket.
 9. Attach Shower Head to Riser. Teflon Tape is not needed.

WALL MOUNT COLD WATER—WM-442-ADA / WM-442-CHV

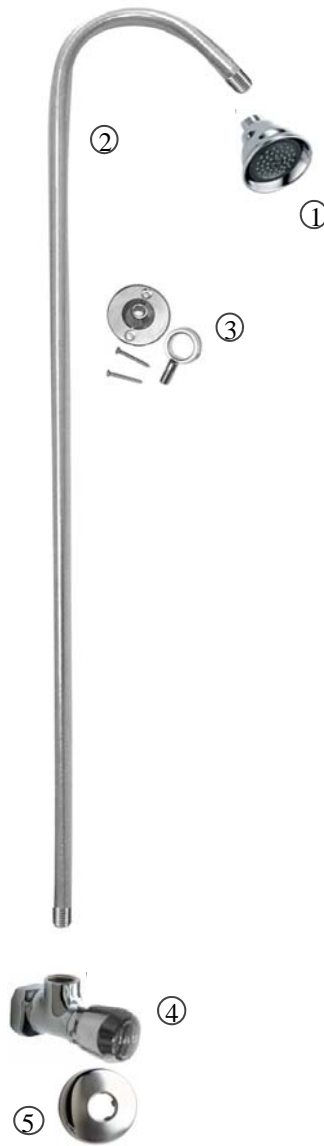
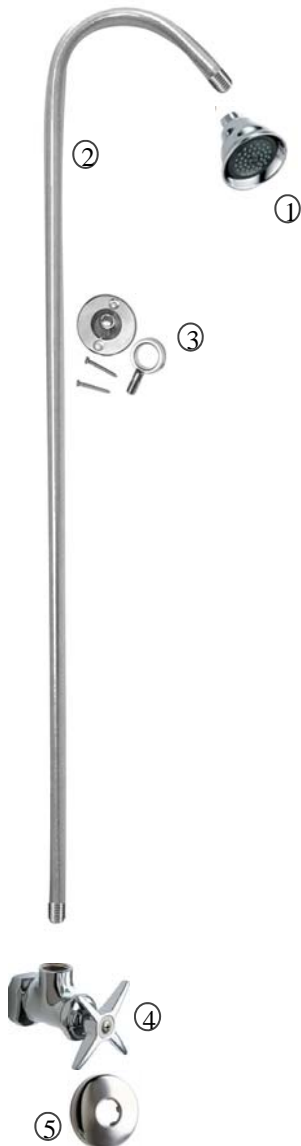

WALL MOUNT COLD WATER—WM-442-ADA / WM-442-CHV



www.outdoorshowerco.com
1-866-shower1 (746-9371)
info@outdoorshowerco.com

WM-442-ADA
WM-442-CHV

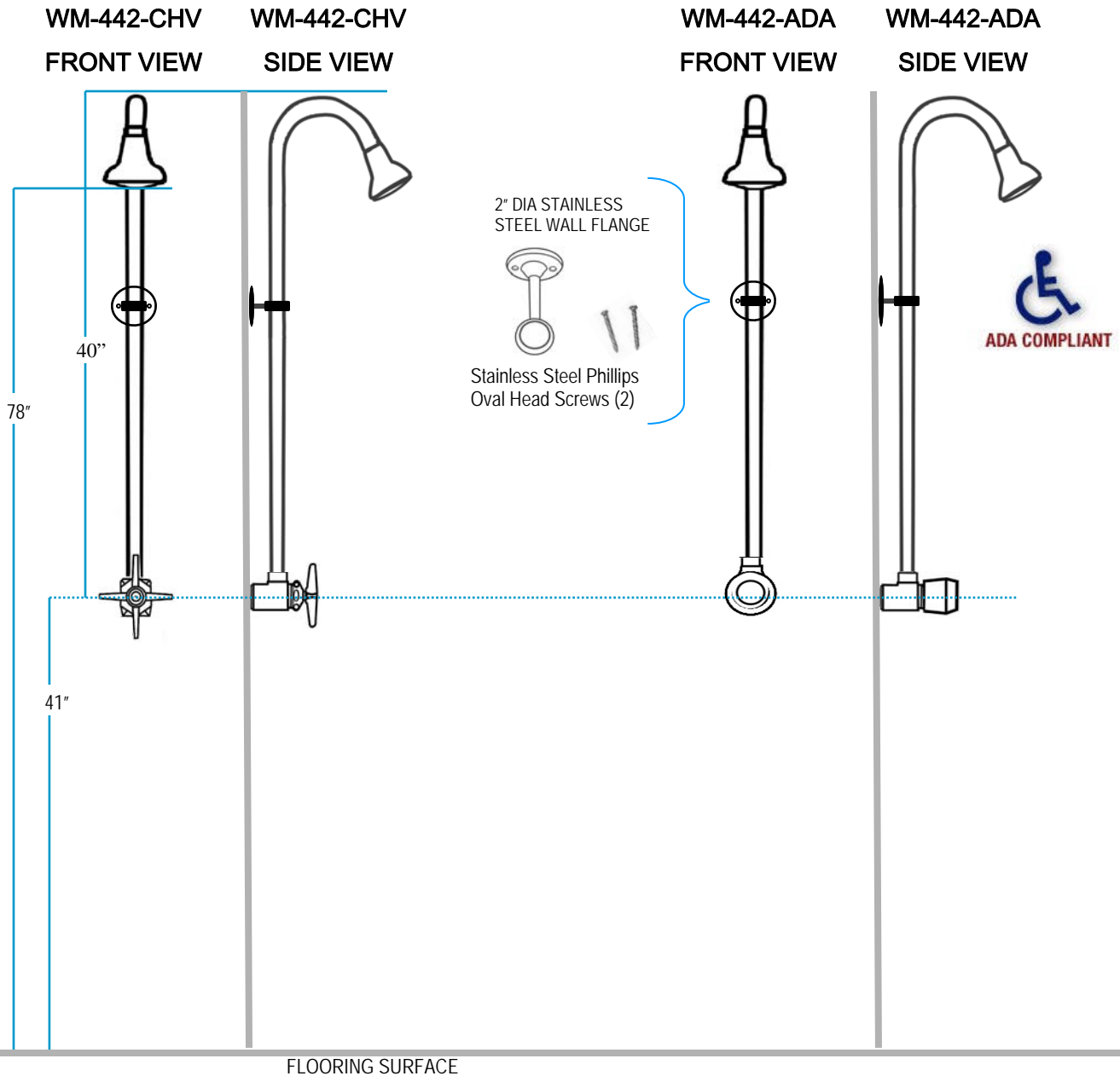

TECHNICAL DATA:

- WALL MOUNT UNIT
- CHROME PLATED BRASS ANGLE VALVE
- 1/2" x 40" 304 STAINLESS STEEL SCH 40 TUBING RISER
- 2.5 GPM CHROME PLATED BRASS SHOWER HEAD
- STAINLESS STEEL 2" DIA FLANGE
- STAINLESS STEEL RING BRACKET
- STAINLESS STEEL SCREWS

- ASME A112.18.1M COMPLIANT
- CSA B125 COMPLIANT

WM-442-ADA / WM-442-CHV ACCESSORIES & REPLACEMENT PARTS

CROSS HANDLE ANGLE VALVE

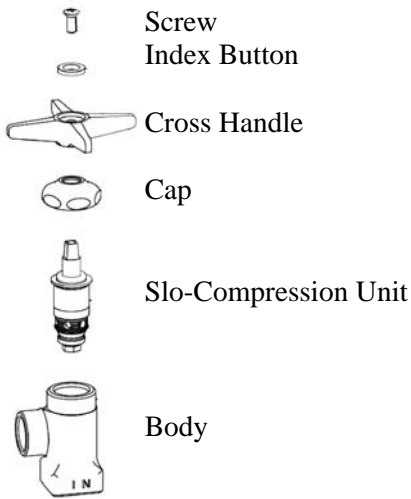

ADA METERED ANGLE VALVE

OPERATES FOR 5 TO 30 SECONDS VALVE CLOSSES WITH WATER PRESSURE

Time is changed by rotating plastic-serrated adjustment nut with a pair of pliers. Raising nut (counter clockwise) shortens time, lowering nut (clockwise) lengthens time. Once cycle time is satisfactory, lock handle in place making sure set screw is securely fastened on groove in stem. Replace button.

Tighten the actuator assembly onto the body to approximately 20 ft. lbs., (Hand tighten and give the actuator

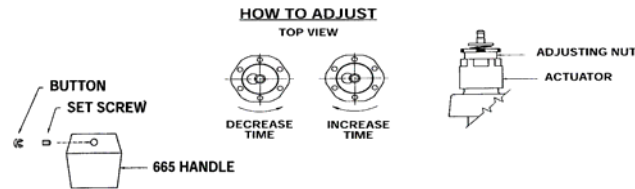
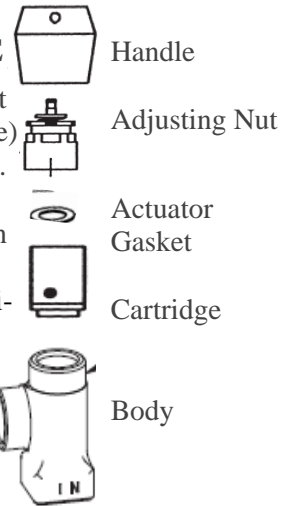

NOTE: Flush supply lines before installing valve to remove chips and dirt which can become lodged in the seat washer and cause the faucet to malfunction.

FREEZE DAMAGE IS NOT COVERED BY WARRANTY.

WINTERIZING: It is recommended that a shut-off valve be installed in the water line going to the pool shower connection where freezing temperatures can occur. Accessories can be removed and other parts partially disassembled for complete protection against freeze damage.

OPTIONAL ACCESSORIES

FS-442-CHV OR FS-442-ADA FOOT SHOWER

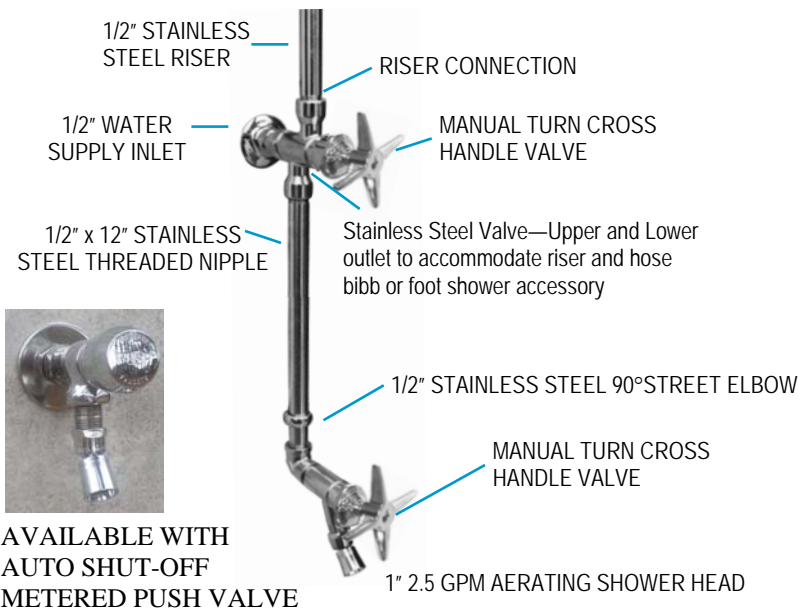

PULL CHAIN VALVE #PCV-053

- 1/2" NPT
- Chrome Plated Brass
- Self-closing Valve
- Stainless Steel Chain
- Stainless Steel Handle

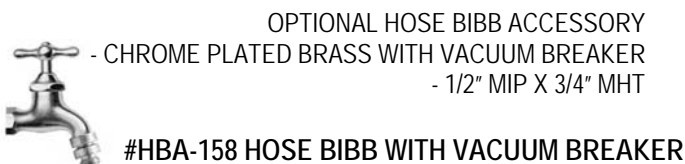
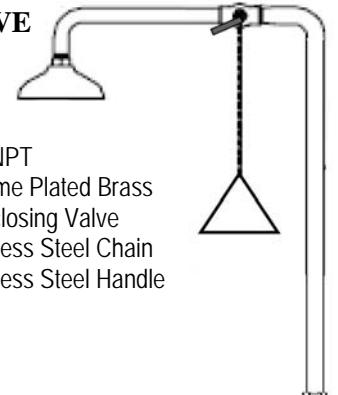

WM-442 Units with 6" or larger Shower Heads have Riser with 90° Bend