

PIONEER FAUCETS

2019 PRICE CATALOG



Multi-Family • Residential • Commercial
QUALITY FAUCETS & FIXTURES

DEDICATED TO BUILDERS & CONTRACTORS

TO OUR VALUED CUSTOMER

The Pioneer family of brands has provided top-quality faucets and fixtures to builders, contractors and designers for over three decades. Each of our brands – Pioneer, Olympia and Central Brass – are uniquely designed to meet the needs of their respective markets, while consistently delivering on the Pioneer promise of excellence and reliability. All of our products are nationally distributed, with warehouses in Los Angeles, CA, and Columbus, OH.

Every Pioneer product is assembled, tested and inspected at our state-of-the-art manufacturing facility. Rigorous quality control measures ensure that each faucet meets our uncompromising standards, as well as all pertinent codes and regulations. Unparalleled reliability and outstanding value, combined with excellent customer service, are why Pioneer products have become the primary choice of some of the nation’s most respected builders and contractors.

From your initial quote to after-sale service and support, we will give you our best and we won’t stop until you’re satisfied.

We thank you for your continued loyalty.

HOW TO ORDER

Simply fax your order, or call our customer service line:

Email: sales@pioneerind.com

Fax Order Number: 323.888.9515

Customer Service Hotline: 800.338.9468

OLYMPIA

Customer Service Hotline: 888.772.7701

Email: sales@olympiafaucets.com

PIONEER

Customer Service Hotline: 800.338.9468

Email: sales@pioneerind.com

CENTRAL BRASS

Customer Service Hotline: 800.321.8630

Email: sales@centralbrass.com

ACTIVE FINISHES:

- Polished Chrome
- PVD Brushed Nickel
- PVD Stainless Steel
- PVD Polished Brass
- PVD Polished Nickel
- Slate Grey
- Moroccan Bronze
- Oil Rubbed Bronze
- Matte Black

For large quantity orders or finishes not listed here, please contact a customer service specialist for lead times and product options.



IAPMO Listed
File# 3778



IAPMO Listed
File# N-5814



IAPMO Listed
File# 6060



IAPMO Listed
File# 6260



Product is compliant with Federal safe drinking water legislation and state level legislation, including AB1953, S152 and HB372.



Product meets Cal Green flow standards: lavatory faucets with a 1.5 GPM rating, and kitchen faucets with a 1.8 GPM or less



Products displaying the ADA logo comply with applicable requirements specified in the Americans Disability Act.



Indicates products that are WaterSense Certified



All Pioneer products are compliant with the Buy America Act.



Indicates products that meet low-flow requirements.

PIONEER INDUSTRIES



PIONEER // 18

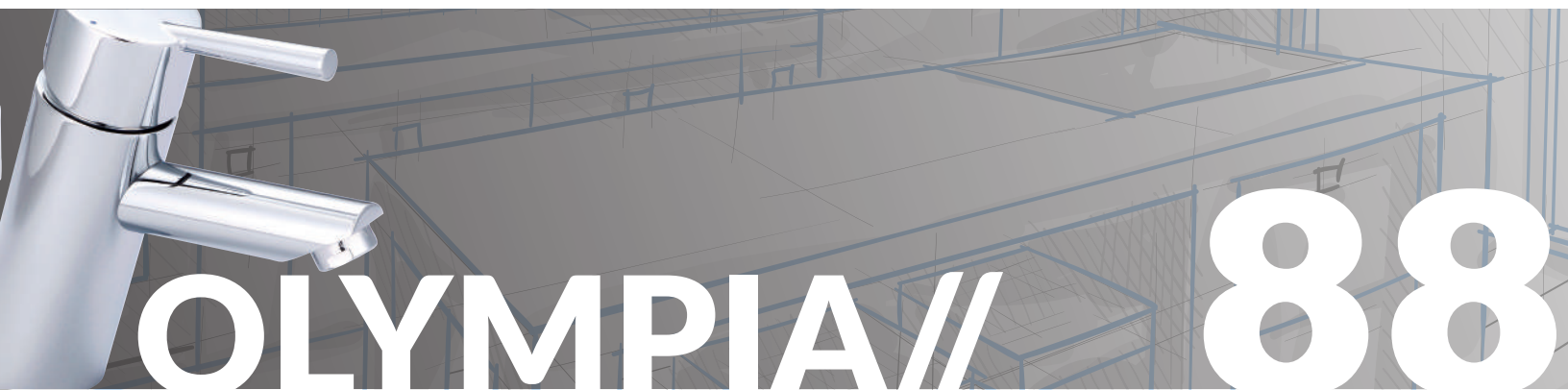

OLYMPIA // 88



CENTRAL
BRASS // 156

PIONEER TABLE OF CONTENTS

PRICE INDEX	12
MOD	
Lavatory Faucets	18
Tub & Shower Trim Sets	21
Bathroom Hardware	25
MOTEGI	
Kitchen Faucets	26
Lavatory Faucets	29
Tub & Shower Sets	32
Bathroom Hardware	37
LEGACY	
Kitchen Faucets	38
Bar Faucets	42
Lavatory Faucets	43
Tub & Shower Trim Sets	49
PREMIUM	
Kitchen Faucets	51
Bar Faucets	52
DEL MAR	
Kitchen Faucets	53
Bar Faucets	55
Lavatory Faucets	56
Tub & Shower Sets	58
AMERICANA	
Kitchen Faucets	62
Lavatory Faucets	64
BRENTWOOD	
Lavatory Faucets	66
ACCESSORIES	68
VALVES	71
CERAMIC DISC CARTRIDGES	74
MISC. PARTS	76
EXTENSIONS & ADAPTERS	78
TERMS & CONDITIONS	232

OLYMPIA TABLE OF CONTENTS

PRICE INDEX	82
I1	
Lavatory	88
Tub & Shower	89
I2	
Kitchen	90
Lavatory	92
Tub & Shower	94
I2V	
Lavatory	96
Tub & Shower	98
I3	
Lavatory	100
Tub & Shower	101
ACCENT	
Kitchen	104
Bar	107
Lavatory	108
Tub & Shower	112
ELITE	
Kitchen	116
Bar	124
Lavatory	126
Tub & Shower	130
VALVES	137
ACCESSORIES	
Lavatory Drains	141
Tub Spouts	142
Showerheads	143
Strainers	144
Miscellaneous	145
Aerators	146
TERMS & CONDITIONS	233

CENTRAL BRASS TABLE OF CONTENTS

PRICE INDEX	150
KITCHEN	
Pre-Rinse Faucets	156
Pre-Rinse Accessories	168
Single Handle Faucets	170
Two Handle Faucets	171
Wallmount Faucets	176
Pot Fillers	178
SERVICE SINK	
Faucets	179
BAR	
Glass Filler	181
Single Handle Faucets	182
Two Handle Faucets	183
BAR / LAUNDRY	
Faucets	184
Laundry Faucets	186
WORKBOARD SINKS	
Workboard Sink Faucets	187
LAVATORY	
Two Handle Faucets	188
Single Basin Faucets	192
TUB & SHOWER	
Sets	193
Trim Kits	198
Specialty Products	200
Bath Drains	204
Bath Drain Trim Kit	206
DRINKING FAUCETS	
Bubbler Heads	207
SPECIALTY	
Wallmount Single Handle Faucets	211
Self-Closing Faucets	212
Valves	213
Lawn Faucets	214
Shampoo Faucets	215
Accessories	216
CHARTS	
Spouts	219
Handles	223
PARTS	225
TERMS & CONDITIONS	234





PIONEER //

2019 PIONEER PRODUCT CATALOG PRICE INDEX

2019 PIONEER PRODUCT CATALOG PRICE INDEX

MODEL	PAGE	PCS/ CS	LIST PRICE	MODEL	PAGE	PCS/ CS	LIST PRICE	MODEL	PAGE	PCS/ CS	LIST PRICE
2AM400	62	6	\$376.00	2MT161H	27	6	\$370.00	3LG110	47	12	\$116.00
2AM400-BN	62	6	\$408.40	2MT161H-BN	27	6	\$396.00	3LG111	47	12	\$88.00
2AM400-ORB	62	6	\$427.00	2MT171H	27	6	\$396.00	3LG121	47	12	\$96.00
2AM401	62	6	\$490.00	2MT171H-BN	27	6	\$427.00	3LG121G	47	12	\$119.00
2AM401-BN	62	6	\$534.40	2MT182H	27	6	\$292.00	3LG130	47	12	\$123.00
2AM401-ORB	62	6	\$563.00	2MT182H-BN	27	6	\$325.00	3LG130-BN	47	12	\$127.00
2AM500	62	6	\$386.00	2MT250	26	6	\$425.00	3LG160	43	12	\$136.00
2AM500-BN	62	6	\$407.00	2MT250-BN	26	6	\$469.00	3LG160B	43	12	\$134.00
2AM501	62	6	\$500.00	2MT250-E1.5	26	6	\$427.00	3LG160B-BN	43	12	\$146.00
2AM501-BN	62	6	\$532.00	2MT250-SS	26	6	\$469.00	3LG160B-E0.5	43	12	\$137.00
2AM501-MZ	62	6	\$573.00	2MT251	26	6	\$394.00	3LG160-BN	43	12	\$148.00
2AM501-ORB	62	6	\$573.00	2MT251-BN	26	6	\$434.00	3LG160-E0.5	43	12	\$139.00
2AM600	62	6	\$364.70	2MT260	26	6	\$447.00	3LG160-E0.5-BN	43	12	\$151.00
2AM600-BN	62	6	\$381.10	2MT260-BN	26	6	\$492.00	3LG160H	43	12	\$138.00
2AM600-MZ	62	6	\$396.00	2MT260-E1.5	26	6	\$449.00	3LG160H-BN	43	12	\$150.00
2AM600-ORB	62	6	\$396.00	2MT260-E1.5-BN	26	6	\$494.00	3LG160H-E0.5	43	12	\$141.00
2AM600-SS	62	6	\$381.10	2MT260-MB	26	6	\$521.00	3LG160H-E0.5-BN	43	12	\$151.00
2AM700	62	6	\$459.00	2MT261	26	6	\$416.00	3LG161	43	12	\$109.00
2AM700-BN	62	6	\$490.00	2MT261-E1.5	26	6	\$419.00	3LG161G	43	12	\$130.00
2AM700-ORB	62	6	\$527.00	2MT270	26	4	\$465.00	3LG260BH	45	12	\$157.00
2DM201	53	6	\$314.00	2MT270-BN	26	4	\$555.00	3LG260BH-BN	45	12	\$168.00
2DM201-BN	53	6	\$340.00	2MT270-MB	26	4	\$582.75	3LG260H	45	12	\$159.00
2DM201-ORB	53	6	\$354.00	2MT275	26	4	\$449.00	3LG260H-BN	45	12	\$170.00
2DM300	53	6	\$170.00	2MT275-BN	26	4	\$536.00	3LG260H-E0.5	45	12	\$162.00
2DM301	53	6	\$203.00	2MT600	28	6	\$376.00	3LG260H-E0.5-BN	45	12	\$173.00
2DM301-BN	53	6	\$219.00	2MT600-BN	28	6	\$402.00	3LG260H-WD	45	12	\$166.00
2LG110	41	12	\$134.00	2MT600-SS	28	6	\$402.00	3LG260H-WD-BN	45	12	\$182.60
2LG160	38	12	\$142.00	2PM440	51	12	\$170.00	3LG262BH	45	12	\$143.00
2LG160B	38	12	\$140.00	2PM540	51	12	\$170.00	3LG264GH	45	12	\$153.00
2LG160-E0.5	38	12	\$145.00	3AM400	64	6	\$381.00	3LG264GH-WD	45	12	\$163.00
2LG160-E1.0	38	12	\$145.00	3AM400-BN	64	6	\$407.00	3LG264H	45	12	\$130.00
2LG160H	38	12	\$144.00	3AM400-MZ	64	6	\$438.00	3LG264H-BN	45	12	\$143.00
2LG160H-BN	38	12	\$156.00	3AM400-ORB	64	6	\$438.00	3LG264H-WD	45	12	\$140.00
2LG161	38	12	\$174.00	3BR300	66	6	\$142.00	3LG264H-WD-BN	45	12	\$154.00
2LG161B	38	12	\$172.00	3BR300-BN	66	6	\$157.00	3MO160	18	6	\$242.00
2LG161B-BN	38	12	\$187.00	3BR300-E1.0	66	6	\$145.00	3MO160-BN	18	6	\$361.20
2LG161-BN	38	12	\$189.00	3BR300-ORB	66	6	\$166.00	3MO160-E0.5	18	6	\$245.00
2LG161H	38	12	\$176.00	3BR310	66	6	\$142.00	3MO160-E0.5-BN	18	6	\$363.00
2LG161H-BN	38	12	\$191.00	3BR310-BN	66	6	\$157.00	3MO160-E1.0	18	6	\$245.00
2LG161H-E0.5	38	12	\$176.00	3BR400	66	6	\$276.00	3MO160-E1.0-BN	18	6	\$363.00
2LG162	38	12	\$178.00	3BR400-BN	66	6	\$292.00	3MO160-MB	18	6	\$290.00
2LG220	40	6	\$227.00	3BR400-ORB	66	6	\$318.00	3MO160-WD	18	6	\$247.00
2LG220-BN	40	6	\$248.00	3BR410	66	6	\$276.00	3MO160-WD-BN	18	6	\$366.20
2LG240	41	6	\$140.00	3BR410-BN	66	6	\$292.00	3MO168	18	6	\$290.50
2LG250	40	6	\$329.00	3DM100	56	6	\$177.00	3MO168-BN	18	6	\$403.80
2LG250-BN	40	6	\$354.00	3DM100-BN	56	6	\$191.70	3MO180	18	6	\$242.00
2LG250-E1.5	40	6	\$331.00	3DM200	57	6	\$301.00	3MO180-BN	18	6	\$361.20
2LG250-E1.5-BN	40	6	\$357.00	3DM200-BN	57	6	\$322.00	3MO180-WD	18	6	\$247.00
2LG260	39	12	\$144.00	3DM200-E0.5	57	6	\$303.00	3MO180-WD-BN	18	6	\$366.20
2LG260-BN	39	12	\$155.00	3DM300	57	6	\$294.00	3MO200	20	6	\$367.40
2LG261	39	12	\$176.00	3DM300-ORB	57	6	\$339.00	3MO200-BN	20	6	\$538.30

2019 PIONEER PRODUCT CATALOG PRICE INDEX

MODEL	PAGE	PCS/ CS	LIST PRICE	MODEL	PAGE	PCS/ CS	LIST PRICE	MODEL	PAGE	PCS/ CS	LIST PRICE
3MO200-E1.0	20	6	\$372.40	4024B-B	73	6	\$93.00	4MT110T-MB	32	6	\$406.00
3MO200-E1.0-BN	20	6	\$540.00	4025B	73	12	\$82.00	4MT111T	33	6	\$264.00
3MO200-MB	20	6	\$441.00	4025B-B	73	12	\$80.00	4MT111T-E1.5	33	6	\$267.00
3MT160	29	6	\$218.00	4027B	73	12	\$85.00	4MT111T-LS	33	6	\$214.00
3MT160B	29	6	\$216.00	4027B-B	73	12	\$83.00	4MT115T	33	6	\$479.00
3MT160-BN	29	6	\$226.00	4100B	73	12	\$83.00	4MT115T-BN	33	6	\$619.00
3MT160-E0.5	29	6	\$221.00	4300B	71	12	\$146.00	4MT120T	32	6	\$349.00
3MT160-E0.5-BN	29	6	\$229.00	4AM100T	65	6	\$386.00	4MT120T-BN	32	6	\$370.00
3MT160-E1.0	29	6	\$223.00	4AM100T-BN	65	6	\$404.70	4MT131T	34	6	\$299.00
3MT160-MB	29	6	\$238.00	4AM100T-ORB	65	6	\$445.80	4MT131T-BN	34	6	\$323.00
3MT161	29	6	\$185.00	4DM100T	58	12	\$200.00	4MT200T	32	6	\$287.00
3MT161-BN	29	6	\$197.00	4DM100T-BN	58	12	\$222.00	4MT200T-BN	32	6	\$308.00
3MT161-E1.0	29	6	\$188.00	4DM300T	58	12	\$180.00	4MT201T	32	6	\$227.50
3MT161-E1.0-BN	29	6	\$200.00	4DM300T-BN	58	12	\$200.00	4MT201T-BN	32	6	\$260.00
3MT161G	29	6	\$210.00	4DM300T-ORB	58	12	\$213.00	4MT300T	32	6	\$229.50
3MT161G-BN	29	6	\$222.00	4DM610T	61	6	\$227.00	4MT300T-BN	32	6	\$297.00
3MT168	29	6	\$248.00	4DM610T-BN	61	6	\$245.00	4MT300T-E1.5	32	6	\$232.50
3MT168-BN	29	6	\$260.00	4LG100T	49	12	\$173.00	4MT300T-MB	32	6	\$317.00
3MT170	30	6	\$218.00	4LG100T-ADA	50	---	\$416.50	4MT315T	33	6	\$319.00
3MT170B	30	6	\$216.00	4LG100T-BN	49	12	\$193.00	4MT320T	33	6	\$194.00
3MT170-BN	30	6	\$226.00	4LG100T-MZ	49	12	\$205.00	4MT320T-BN	33	6	\$271.00
3MT170-E0.5	30	6	\$221.00	4LG300T	49	12	\$155.00	4MT330T	34	6	\$239.00
3MT170-E0.5-BN	30	6	\$229.00	4LG300T-ADA	50	---	\$381.70	4MT330T-BN	34	6	\$295.00
3MT170-E1.0	30	6	\$221.00	4LG400T	49	12	\$114.00	4MT330T-E1.5	34	6	\$242.00
3MT170-E1.0-BN	30	6	\$229.00	4LG400T-ADA	50	---	\$343.00	4MT400T	34	6	\$183.00
3MT170-MB	30	6	\$248.00	4LG400T-BN	49	12	\$131.00	4MT400T-BN	34	6	\$203.00
3MT178	30	6	\$248.00	4MO100T	21	6	\$206.75	4MT610	36	4	\$444.00
3MT180	30	6	\$318.00	4MO100T-BN	21	6	\$289.50	4MT610-BN	36	4	\$464.00
3MT180-BN	30	6	\$334.00	4MO100T-E1.5	21	6	\$209.00	4MT840	36	6	\$313.00
3MT180-MB	30	6	\$348.00	4MO100T-E1.5-BN	21	6	\$291.50	4MT840-BN	36	6	\$329.00
3MT400	31	6	\$381.00	4MO100T-MB	21	6	\$379.60	5DM100	55	12	\$119.00
3MT400-BN	31	6	\$402.00	4MO110T	22	6	\$189.00	5DM100-BN	55	12	\$131.00
3MT400-E1.0	31	6	\$384.00	4MO110T-BN	22	6	\$253.00	5DM100-ORB	55	12	\$136.00
3MT420	31	6	\$320.00	4MO110T-MB	22	6	\$278.00	5LG120	42	12	\$104.00
3MT420-BN	31	6	\$352.00	4MO200T	21	6	\$169.00	5LG220	42	12	\$106.00
3MT500	31	6	\$381.00	4MO200T-BN	21	6	\$218.00	5PM330	52	6	\$193.00
3MT500-BN	31	6	\$402.00	4MO300T	21	6	\$170.00	6DM400	60	6	\$245.00
3MT800	30	6	\$263.70	4MO300T-BN	21	6	\$219.50	6DM400-BN	60	6	\$265.00
3MT800-BN	30	6	\$271.00	4MO300T-E1.5	21	6	\$173.00	6DM400-ORB	60	6	\$276.00
3MT800-E1.0	30	6	\$266.00	4MO310T	22	6	\$124.00	6MO101T	23	6	\$82.00
3MT800-MB	30	6	\$282.00	4MO310T-BN	22	6	\$166.00	6MO101T-BN	23	6	\$92.00
4020B	72	12	\$68.00	4MO310T-MB	22	6	\$182.60	6MO400	23	6	\$349.00
4020B-B	72	12	\$66.00	4MO400T	23	6	\$96.00	6MO400-BN	23	6	\$439.00
4020B-D	72	6	\$151.00	4MO400T-BN	23	6	\$119.70	6MT101T	34	12	\$78.00
4021B	72	12	\$88.00	4MO610T	24	6	\$369.90	6MT101T-BN	34	12	\$87.00
4021B-B	72	12	\$86.00	4MO610T-BN	24	6	\$465.40	6MT400	35	6	\$412.00
4022B	72	12	\$88.00	4MO611	24	4	\$730.80	6MT400-BN	35	6	\$427.00
4022B-B	72	12	\$86.00	4MO611-BN	24	4	\$921.70	6MT410	35	6	\$198.00
4023B	72	12	\$88.00	4MT110T	32	6	\$376.00	6MT410-BN	35	6	\$209.00
4023B-B	72	12	\$86.00	4MT110T-BN	32	6	\$396.00	7MO030	25	20	\$72.00
4024B	73	6	\$96.00	4MT110T-LS	32	6	\$322.00	7MO030-BN	25	20	\$93.00

2019 PIONEER PRODUCT CATALOG PRICE INDEX

MODEL	PAGE	PCS/ CS	LIST PRICE	MODEL	PAGE	PCS/ CS	LIST PRICE	MODEL	PAGE	PCS/ CS	LIST PRICE
7MO030-MB	25	20	\$86.00	X-1300020	20	---	\$32.50	X-2300009	67	---	\$132.00
7MO031	25	20	\$69.30	X-1400002	61	---	\$29.45	X-2300021	20	---	\$172.00
7MO031-BN	25	20	\$90.30	X-1400006	36	---	\$42.00	X-2400001	36	---	\$103.00
7MO031-MB	25	20	\$83.00	X-1400025	50	---	\$19.30	X-2400003	61	---	\$202.00
7MO032	25	40	\$47.80	X-1400026	59	---	\$30.45	X-2400007	36	---	\$215.00
7MO032-BN	25	40	\$60.40	X-1400028	34	---	\$37.00	X-2400019	24	---	\$333.29
7MO032-MB	25	40	\$57.50	X-1400029	65	---	\$87.00	X-2400020	24	---	\$385.00
7MO033	25	40	\$32.60	X-1400043	22	---	\$32.50	X-2400021	36	---	\$130.00
7MO033-BN	25	40	\$38.90	X-1400044	24	---	\$32.50	X-2500001	42	---	\$45.00
7MO033-MB	25	40	\$39.00	X-1600001	34	---	\$31.50	X-2500002	42	---	\$52.00
7MO034	25	40	\$43.60	X-1900001C	48	---	\$5.35	X-2500003	52	---	\$99.00
7MO034-BN	25	40	\$56.70	X-1900001H	48	---	\$5.35	X-3200001	74	---	\$16.00
7MO034-MB	25	40	\$52.50	X-1900002C	41	---	\$10.95	X-3200002	77	---	\$3.30
7MT030	37	20	\$120.00	X-1900002H	41	---	\$10.95	X-3200003	76	---	\$14.00
7MT030-BN	37	20	\$127.00	X-1900003C	41	---	\$18.30	X-3200004C	76	---	\$24.40
7MT031	37	20	\$110.00	X-1900003H	41	---	\$18.30	X-3200004H	76	---	\$24.40
7MT031-BN	37	20	\$117.00	X-1900004C	48	---	\$19.55	X-3300002C	67	---	\$13.20
7MT032	37	40	\$63.00	X-1900004H	48	---	\$19.55	X-3300002H	67	---	\$13.20
7MT032-BN	37	40	\$67.00	X-1900005	55	---	\$22.35	X-3300006	19	---	\$12.75
7MT033	37	40	\$63.00	X-1900007C	64	---	\$47.00	X-3300007	19	---	\$14.25
7MT033-BN	37	40	\$67.00	X-1900007H	64	---	\$47.00	X-3400001	76	---	\$9.40
7MT034	37	40	\$63.00	X-1900008	28	---	\$22.35	X-3400004	24	---	\$121.66
7MT034-BN	37	40	\$67.00	X-1900009C	67	---	\$29.45	X-3400007	47	---	\$49.00
OP-460025	23	---	\$1.50	X-1900009H	67	---	\$29.45	X-3900001	75	---	\$13.20
OP-460027	23	---	\$22.00	X-1900010C	67	---	\$18.30	X-3900002C	76	---	\$10.70
OP-640042	22	---	\$52.00	X-1900010H	67	---	\$18.30	X-390000H	76	---	\$10.70
OP-640043	22	---	\$89.00	X-1900011C	67	---	\$16.25	X-3600001	75	---	\$22.35
X-1200001	39	---	\$22.35	X-1900011H	67	---	\$16.25	X-3600003	75	---	\$19.97
X-1200002	39	---	\$22.35	X-1900012C	67	---	\$21.35	X-3900002H	20	---	\$10.70
X-1200004	52	---	\$16.75	X-1900012H	67	---	\$21.35	X-3900003	75	---	\$12.95
X-1200005C	51	---	\$15.00	X-2200001	39	---	\$65.00	X-3900004C	76	---	\$11.60
X-1200005H	51	---	\$15.00	X-2200002	41	---	\$65.00	X-3900004H	76	---	\$11.60
X-1200006	54	---	\$22.35	X-2200003	41	---	\$68.00	X-4200001	22	---	\$7.40
X-1200007C	63	---	\$48.00	X-2200004	54	---	\$102.00	X-4200002	39	---	\$4.60
X-1200007H	63	---	\$48.00	X-2200005	54	---	\$147.00	X-4200003	39	---	\$0.80
X-1200008C	63	---	\$51.00	X-2200008	51	---	\$45.00	X-4200004	39	---	\$1.30
X-1200008H	63	---	\$51.00	X-2200009	51	---	\$44.00	X-4200005	39	---	\$30.45
X-1200009	63	---	\$55.00	X-2200012	63	---	\$165.00	X-4200006	39	---	\$2.30
X-1200010	63	---	\$27.45	X-2200013	63	---	\$167.00	X-4200007	77	---	\$2.30
X-1200011	28	---	\$22.35	X-2200014	28	---	\$179.00	X-4200008	39	---	\$67.16
X-1200012	28	---	\$24.40	X-2200015	28	---	\$192.00	X-4200009	39	---	\$42.00
X-1200016	40	---	\$19.05	X-2200017	28	---	\$179.00	X-4200010	39	---	\$29.45
X-1200018	28	---	\$31.50	X-2200018	28	---	\$79.00	X-4200011	41	---	\$3.30
X-1200019	28	---	\$26.40	X-2200019	28	---	\$99.00	X-4200012	41	---	\$1.30
X-1300001	44	---	\$22.35	X-2300001	57	---	\$154.00	X-4200013	41	---	\$1.57
X-1300002	44	---	\$22.35	X-2300002	57	---	\$142.00	X-4200014	41	---	\$24.40
X-1300003	44	---	\$7.65	X-2300003	64	---	\$172.00	X-4200015	41	---	\$3.84
X-1300004C	64	---	\$45.00	X-2300004	31	---	\$158.00	X-4200016	77	---	\$8.09
X-1300004H	64	---	\$45.00	X-2300005	31	---	\$81.00	X-4200017	41	---	\$22.36
X-1300006	31	---	\$18.55	X-2300006	31	---	\$88.00	X-4200018	54	---	\$31.50
X-1300019	19	---	\$24.40	X-2300008	67	---	\$137.00	X-4200020	54	---	\$39.00

2019 PIONEER PRODUCT CATALOG PRICE INDEX

MODEL	PAGE	PCS/ CS	LIST PRICE	MODEL	PAGE	PCS/ CS	LIST PRICE	MODEL	PAGE	PCS/ CS	LIST PRICE
X-4200021	54	---	\$28.45	X-4300061	56	---	\$14.00	X-4600016	35	---	\$90.00
X-4200022	54	---	\$2.30	X-4300062	56	---	\$18.55	X-4600025	50	---	\$2.30
X-4200023	54	---	\$17.55	X-4300063	57	---	\$12.45	X-4600031	35	---	\$56.00
X-4200025	54	---	\$35.00	X-4300064	57	---	\$14.50	X-4600032	35	---	\$20.05
X-4200032	52	---	\$4.35	X-4300065	57	---	\$20.60	X-4600035	50	---	\$26.40
X-4200041	40	---	\$8.90	X-4300087	19	---	\$16.50	X-4600036	50	---	\$1.30
X-4200044	52	---	\$9.15	X-4300088	19	---	\$5.25	X-4600045	78	---	\$20.05
X-4200045	52	---	\$6.35	X-4300089	19	---	\$3.00	X-4600048	60	---	\$106.03
X-4200046	77	---	\$2.30	X-4300090	19	---	\$9.00	X-4600058	23	---	\$102.00
X-4200048	52	---	\$13.45	X-4300091	19	---	\$11.25	X-4600059	23	---	\$109.00
X-4200049	54	---	\$2.30	X-4300093	20	---	\$0.75	X-4900001	39	---	\$1.05
X-4200050	52	---	\$1.30	X-4300094	20	---	\$11.25	X-4900002	20	---	\$1.30
X-4200051	52	---	\$1.30	X-4400002	59	---	\$10.95	X-4900004	24	---	\$3.30
X-4200053	51	---	\$5.60	X-4400005	77	---	\$44.00	X-4900005C	48	---	\$1.30
X-4200054	51	---	\$8.15	X-4400014	61	---	\$35.00	X-4900005H	48	---	\$1.30
X-4200055C	51	---	\$3.30	X-4400015	61	---	\$41.00	X-4900006	48	---	\$1.30
X-4200055H	51	---	\$3.30	X-4400016	61	---	\$7.40	X-4900007	41	---	\$1.80
X-4200056	51	---	\$27.45	X-4400017	61	---	\$1.30	X-4900008	41	---	\$1.30
X-4200057	51	---	\$9.15	X-4400018	61	---	\$0.80	X-4900009C	41	---	\$1.30
X-4200058	41	---	\$5.85	X-4400024	40	---	\$1.30	X-4900009H	41	---	\$1.30
X-4200059	63	---	\$121.00	X-4400028	24	---	\$1.30	X-4900010	41	---	\$1.30
X-4200070	28	---	\$185.99	X-4400030	22	---	\$23.35	X-4900011C	41	---	\$0.80
X-4200089	40	---	\$37.44	X-4400043	34	---	\$80.00	X-4900011H	41	---	\$0.80
X-4200090	51	---	\$1.30	X-4400058	24	---	\$0.80	X-4900012	41	---	\$1.30
X-4200109	39	---	\$25.40	X-4400062	50	---	\$4.85	X-4900013	41	---	\$1.30
X-4200111	40	---	\$24.40	X-4400063	24	---	\$13.45	X-4900014C	48	---	\$2.30
X-4200112	40	---	\$1.55	X-4400065	65	---	\$27.45	X-4900014H	48	---	\$2.30
X-4200113	40	---	\$0.80	X-4400070	77	---	\$36.00	X-4900015	48	---	\$1.30
X-4200114	54	---	\$10.70	X-4400073	24	---	\$3.05	X-4900017	44	---	\$11.95
X-4200152	40	---	\$23.35	X-4400080	22	---	\$4.35	X-4900018	44	---	\$4.10
X-4200155	78	---	\$7.65	X-4400088	78	---	\$38.00	X-4900019	77	---	\$1.30
X-4200169	40	---	\$32.50	X-4400089	78	---	\$49.00	X-4900020	57	---	\$21.35
X-4200180	28	---	\$57.17	X-4400099	19	---	\$1.30	X-4900022	20	---	\$4.35
X-4200181	28	---	\$49.00	X-4400102	24	---	\$4.85	X-4900023	54	---	\$18.30
X-4300003	44	---	\$1.80	X-4400105	34	---	\$23.00	X-4900024	20	---	\$1.30
X-4300004	44	---	\$2.30	X-4400106	23	---	\$78.75	X-4900026	61	---	\$0.80
X-4300005	44	---	\$0.80	X-4400108	24	---	\$25.50	X-4900029	51	---	\$1.30
X-4300006	56	---	\$2.30	X-4400109	24	---	\$30.00	X-4900030	51	---	\$1.80
X-4300008	56	---	\$12.95	X-4400113	24	---	\$11.25	X-4900032	64	---	\$11.95
X-4300010	57	---	\$17.55	X-4400114	24	---	\$9.75	X-4900034	64	---	\$15.75
X-4300011	20	---	\$16.00	X-4500001	42	---	\$11.95	X-4900035	64	---	\$1.30
X-4300015	64	---	\$11.45	X-4500002	42	---	\$14.50	X-4900036	64	---	\$1.30
X-4300018	64	---	\$1.30	X-4500003	42	---	\$1.80	X-4900037	42	---	\$1.95
X-4300022	31	---	\$90.00	X-4600001	60	---	\$31.50	X-4900038	64	---	\$1.30
X-4300024	46	---	\$1.30	X-4600002	60	---	\$1.30	X-4900041	31	---	\$4.85
X-4300038	46	---	\$16.75	X-4600003	35	---	\$99.00	X-4900042C	64	---	\$2.30
X-4300041	57	---	\$14.50	X-4600004	60	---	\$45.00	X-4900042H	64	---	\$2.30
X-4300043	31	---	\$45.00	X-4600005	23	---	\$14.50	X-4900044	19	---	\$2.05
X-4300047	48	---	\$13.45	X-4600006	24	---	\$120.00	X-4900047	24	---	\$1.30
X-4300058	48	---	\$8.90	X-4600011	34	---	\$40.00	X-4900066	41	---	\$1.30
X-4300059	48	---	\$9.40	X-4600015	35	---	\$59.00	X-4900072	28	---	\$7.65

2019 PIONEER PRODUCT CATALOG PRICE INDEX

MODEL	PAGE	PCS/ CS	LIST PRICE
X-4900073	28	---	\$14.75
X-4900080	22	---	\$1.30
X-4900081	39	---	\$8.90
X-4900082	41	---	\$9.40
X-4900083	41	---	\$13.20
X-4900084	42	---	\$9.40
X-4900085	42	---	\$10.15
X-4900086	42	---	\$14.00
X-4900089	28	---	\$6.60
X-4900091	63	---	\$12.95
X-4900092	63	---	\$9.90
X-4900093	63	---	\$17.55
X-4900095	67	---	\$12.20
X-4900096	67	---	\$9.15
X-4900097	67	---	\$16.25
X-4900105	78	---	\$7.84
X-4900112	35	---	\$91.49
X-4900116	42	---	\$0.70
X-4900117	74	---	\$399.00
X-4900125	31	---	\$42.00
X-4900125-BN	31	---	\$49.00
X-5200003	52	---	\$3.30
X-5200006	39	---	\$2.30
X-5200008	52	---	\$5.35
X-5200009	52	---	\$2.80
X-5200015	39	---	\$7.40
X-5200019	40	---	\$4.98
X-5200021	40	---	\$7.40
X-5300001	44	---	\$2.80
X-5300003	20	---	\$2.80
X-5300005	64	---	\$2.30
X-5300007	46	---	\$6.60
X-5300008	19	---	\$16.50
X-5300012	19	---	\$8.40
X-5400003	24	---	\$16.75
X-5400008	78	---	\$3.60
X-5400009	78	---	\$5.10
X-5400010	78	---	\$5.85
X-5600001	60	---	\$1.30
X-5600004	24	---	\$3.85
X-5900001	20	---	\$7.15
X-6300001	44	---	\$40.00
X-6300002	31	---	\$51.00
X-6300003	56	---	\$36.00
X-6300005	64	---	\$49.00
X-6300006	31	---	\$39.00
X-6300008	67	---	\$41.00
X-6300010	70	---	\$65.00
X-6300011	70	---	\$65.00
X-6300012	57	---	\$41.00
X-6300020	64	---	\$54.00

MODEL	PAGE	PCS/ CS	LIST PRICE
X-6300029	19	---	\$45.75
X-6300030	20	---	\$47.25
X-6400002	22	---	\$13.20
X-6400003	50	---	\$10.95
X-6400004	65	---	\$123.00
X-6400005	65	---	\$56.00
X-6400006	65	---	\$21.35
X-6400007	65	---	\$47.00
X-6400008	65	---	\$40.00
X-6400011	34	---	\$15.00
X-6400012	69	---	\$202.00
X-6400013	69	---	\$64.00
X-6400014	68	---	\$52.00
X-6400015	59	---	\$4.85
X-6400019	34	---	\$30.45
X-6400021	59	---	\$39.00
X-6400022	65	---	\$28.45
X-6400024	34	---	\$96.00
X-6400029	70	---	\$24.40
X-6400029-BN	70	---	\$25.40
X-6400029-ORB	70	---	\$27.45
X-6400030	70	---	\$20.30
X-6400030-BN	70	---	\$21.35
X-6400030-ORB	70	---	\$24.40
X-6400031	70	---	\$16.00
X-6400031-BN	70	---	\$16.75
X-6400031-ORB	70	---	\$19.30
X-6400032	70	---	\$10.70
X-6400032-BN	70	---	\$11.95
X-6400032-ORB	70	---	\$13.45
X-6400033	70	---	\$9.90
X-6400033-BN	70	---	\$10.70
X-6400033-ORB	70	---	\$11.20
X-6400034	70	---	\$8.40
X-6400034-BN	70	---	\$9.15
X-6400034-ORB	70	---	\$9.90
X-6400036	68	---	\$102.00
X-6400038	69	---	\$266.00
X-6400045	68	---	\$44.00
X-6400045-BN	68	---	\$46.00
X-6400051	34	---	\$202.00
X-6400052	68	---	\$32.50
X-6400052-BN	68	---	\$39.00
X-6400055	68	---	\$55.00
X-6400055-BN	68	---	\$58.00
X-6400058	50	---	\$45.00
X-6400059	59	---	\$40.00
X-6400064	22	---	\$39.00
X-6400077	22	---	\$121.00
X-6400078	69	---	\$121.00
X-6400079	50	---	\$35.00





MODEL	PAGE	PCS/ CS	LIST PRICE
X-6400081	68	---	\$25.40
X-6400081-BN	68	---	\$39.00
X-6400083	34	---	\$65.00
X-6400086	22	---	\$80.25
X-6400095	69	---	\$60.00
X-6400097	69	---	\$124.65
X-6400102	34	---	\$38.00
X-6400103	22	---	\$11.45
X-6400104	22	---	\$30.00
X-6400108	69	---	\$202.00

2019 PIONEER PRODUCT CATALOG PRICE INDEX



MOD // Lavatory Faucets

SINGLE HANDLE LAVATORY FAUCETS

	Model#	Description	Finish	Case	Price
	3MO160	Single Handle Lavatory Faucet Metal Lever Handle	Polished Chrome	6	\$242.00
	3MO160-BN	Rigid Spout	PVD Brushed Nickel	6	\$361.20
	3MO160-MB	4-3/8" Reach, 4" from Deck to Aerator Ceramic Disc Cartridge 1-Hole Installation Easy-Install 18" Flex Supply Lines With 3/8" Connections Brass Pop-Up Drain Assembly With 1.2 GPM Laminar Flow Rate	Matte Black	6	\$290.00
	3MO160-E0.5	With 0.5 GPM Flow Rate	Polished Chrome	6	\$245.00
	3MO160-E0.5-BN		PVD Brushed Nickel	6	\$363.00
	3MO160-E1.0	With 1.0 GPM Flow Rate	Polished Chrome	6	\$245.00
	3MO160-E1.0-BN		PVD Brushed Nickel	6	\$363.00
	3MO160-WD	Single Handle Lavatory Faucet Metal Lever Handle	Polished Chrome	6	\$247.00
	3MO160-WD-BN	Rigid Spout 4-3/8" Reach, 4" from Deck to Aerator Ceramic Disc Cartridge 1 or 3-Hole 4" Installation Easy-Install 18" Flex Supply Lines With 3/8" Connections Brass Pop-Up Drain Assembly Deck Cover Plate Included With 1.2 GPM Laminar Flow Rate	PVD Brushed Nickel	6	\$366.20
	3MO168	Single Handle Lavatory Faucet Metal Lever Handle	Polished Chrome	6	\$290.50
	3MO168-BN	Rigid Spout 4-3/8" Reach, 12" from Deck to Aerator Ceramic Disc Cartridge 1-Hole Installation Easy-Install 18" Flex Supply Lines With 3/8" Connections With 1.2 GPM Laminar Flow Rate	PVD Brushed Nickel	6	\$403.80
	3MO180	Single Handle Lavatory Faucet Metal Lever Handle	Polished Chrome	6	\$242.00
	3MO180-BN	Rigid Spout 4-7/8" Reach, 6" from Deck to Aerator Ceramic Disc Cartridge 1-Hole Installation Easy-Install 18" Flex Supply Lines With 3/8" Connections Brass Pop-Up Drain Assembly With 1.2 GPM Laminar Flow Rate	PVD Brushed Nickel	6	\$361.20
	3MO180-WD	Single Handle Lavatory Faucet Metal Lever Handle	Polished Chrome	6	\$247.00
	3MO180-WD-BN	Rigid Spout 4-7/8" Reach, 6" from Deck to Aerator Ceramic Disc Cartridge 1 or 3-Hole 4" Installation Easy-Install 18" Flex Supply Lines With 3/8" Connections Brass Pop-Up Drain Assembly Deck Cover Plate Included With 1.2 GPM Laminar Flow Rate	PVD Brushed Nickel	6	\$366.20

Low flow aerators available upon request.
See page 3 for special order finish options.

Pioneer faucets feature aerators that meet ANSI/ASME A112.18.1 flow requirements of 1.5 GPM

MOD // Lavatory Faucets

SINGLE HANDLE LAVATORY FAUCETS

	Model#	Description	Finish	Case	Price
PARTS	X-1300019	Metal Lever Handle	Polished Chrome	---	\$24.40
	X-3300006	Ceramic Disc Cartridge	---	---	\$12.75
	X-3300007	Ceramic Disc Cartridge	---	---	\$14.25
	X-4300087	Deck Plate	Polished Chrome	---	\$16.50
	X-4300088	Cap	Polished Chrome	---	\$5.25
	X-4300089	Locknut	---	---	\$3.00
	X-4300091	Escutcheon	Polished Chrome	---	\$11.25
	X-4400099	Allen Screw	---	---	\$1.30
	X-4900044	Hole Cover	Polished Chrome	---	\$2.05
	X-5300008	Mounting Kit	---	---	\$16.50
	X-5300012	Mounting Kit	---	---	\$8.40
	X-6300029	Pop-Up Drain Assembly	Polished Chrome	---	\$45.75
	X-4300090	1.5 GPM Aerator	Polished Chrome	---	\$9.00



Low flow aerators available upon request.

Pioneer faucets feature aerators that meet ANSI/ASME A112.18.1 flow requirements of 1.5 GPM

MOD

MOD // Lavatory Faucets

TWO HANDLE LAVATORY FAUCETS







		Model#	Description	Finish	Case	Price
		3MO200	Two Handle Lavatory Widespread Faucet Metal Lever Handle	Polished Chrome	6	\$367.40
		3MO200-BN	Rigid Spout	PVD Brushed Nickel	6	\$538.30
		3MO200-MB	4-7/8" Reach, 3-3/8" from Deck to Aerator Ceramic Disc Cartridge 3-Hole 6" to 16" Installation Easy-Install 18" Flex Supply Lines With 3/8" Connections Brass Pop-Up Drain Assembly With 1.2 GPM Laminar Flow Rate	Matte Black	6	\$441.00
		3MO200-E1.0	With a 1.0 GPM Flow Rate	Polished Chrome	6	\$372.40
		3MO200-E1.0-BN		PVD Brushed Nickel	6	\$540.00
		PARTS		X-4300093	Red/Blue Index Button	---
		X-1300020	Metal Lever Handle	Polished Chrome	---	\$32.50
		X-4300094	Valve Escutcheon	Polished Chrome	---	\$11.25
		X-5900001	Valve Mounting Kit	---	---	\$7.15
		X-4900022	Bonnet Nut	---	---	\$4.35
		X-3900002C	Ceramic Disc Cartridge-Cold	---	---	\$10.70
		X-3900002H	Ceramic Disc Cartridge-Hot	---	---	\$10.70
		X-4900024	3/32" Allen Wrench	---	---	\$1.30
		X-2300021	Square Rigid Spout	Polished Chrome	---	\$172.00
		X-5300003	Spout Mounting Kit	---	---	\$2.80
		X-4300011	Y Connector	---	---	\$16.00
		X-6300030	Pop-up Drain Assembly	Polished Chrome	---	\$47.25
		X-4900002	3/32" Allen Screw	---	---	\$1.30
		X-4900044	Hole Cover	Polished Chrome	---	\$2.05
		X-4300091	Spout Escutcheon	Polished Chrome	---	\$11.25
		X-4300090	1.5 GPM Aerator	Polished Chrome	---	\$9.00

Low flow aerators available upon request.
See page 3 for special order finish options.

Pioneer faucets feature aerators that meet ANSI/ASME A112.18.1 flow requirements of 1.5 GPM

MOD // Tub & Shower

TUB & SHOWER TRIM SETS

	Model#	Description	Finish	Case	Price
	 4MO100T	Single Handle Tub and Shower Trim Set Metal Lever Handle	Polished Chrome	6	\$206.75
	4MO100T-BN	Ceramic Disc Cartridge with Temperature Limit Cap Single Function 6" Square Showerhead	PVD Brushed Nickel	6	\$289.50
	4MO100T-MB	8-7/8" L Shape Shower Arm And Shower Arm Flange Combo 1/2" IPS/Slip-On Diverter Tub Spout With Escutcheon Color Match Sleeve and Retaining Ring With 1.75 GPM Flow Rate For Use with 4020B Valve - Valve not included	Matte Black	6	\$379.60
	4MO100T-E1.5	With 1.5 GPM Flow Rate	Polished Chrome	6	\$209.00
	4MO100T-E1.5-BN		PVD Brushed Nickel	6	\$291.50
	 4MO200T	Single Handle Tub Trim Set Metal Lever Handle	Polished Chrome	6	\$169.00
	4MO200T-BN	Ceramic Disc Cartridge with Temperature Limit Cap Extended Combo 1/2" IPS/Slip-On Tub Spout with Escutcheon Color Match Sleeve and Retaining Ring For Use with 4020B Valve - Valve not included	PVD Brushed Nickel	6	\$218.00
	 4MO300T	Single Handle Shower Trim Set Metal Lever Handle	Polished Chrome	6	\$170.00
	4MO300T-BN	Ceramic Disc Cartridge with Temperature Limit Stop Single Function 6" Square Showerhead 8-7/8" L Shape Shower Arm And Shower Arm Flange With 1.75 GPM Flow Rate For Use with 4020B Valve - Valve not included	PVD Brushed Nickel	6	\$219.50
	4MO300T-E1.5	With 1.5 GPM Flow Rate	Polished Chrome	6	\$173.00



Low flow showerheads available upon request.
See page 3 for special order finish options.

Pioneer showerheads meet ANSI/ASME A112.18.1 flow requirements of maximum 1.75 GPM

MOD

MOD // Tub & Shower

TUB & SHOWER TRIM SETS



	Model#	Description	Finish	Case	Price
	4MO110T	Single Handle Tub and Shower Trim Set Lever Handle	Polished Chrome	6	\$189.00
	4MO110T-BN	Ceramic Disc Cartridge with Temperature Limit Cap Single Function 4" Square Showerhead	PVD Brushed Nickel	6	\$253.00
	4MO110T-MB	Shower Arm and Flange Extended Combo 1/2" IPS/Slip-On Diverter Tub Spout with Escutcheon Color Match Sleeve and Retaining Ring With 1.75 GPM Flow Rate For Use with 4020B Valve – Valve not included	Matte Black	6	\$278.00
	4MO310T	Single Handle Shower Trim Set Metal Lever Handle	Polished Chrome	6	\$124.00
	4MO310T-BN	Ceramic Disc Cartridge with Temperature Limit Cap Single Function 4" Square Showerhead	PVD Brushed Nickel	6	\$166.00
	4MO310T-MB	Shower Arm and Flange Color Match Sleeve and Retaining Ring With 1.75 GPM Flow Rate For Use with 4020B Valve - Valve not included	Matte Black	6	\$182.60
PARTS	X-6400077	2.5 GPM Single Function 6" Square Showerhead	Polished Chrome	---	\$121.00
	X-6400104	Shower Arm	Polished Chrome	---	\$30.00
	OP-640042	1.75 GPM Single Function 4" Square Showerhead	Polished Chrome	---	\$52.00
	X-6400002	Shower Arm	Polished Chrome	---	\$13.20
	X-6400103	Shower Arm Flange	Polished Chrome	---	\$11.45
	X-1400043	Metal Lever Handle	Polished Chrome	---	\$32.50
	X-6400064	Face Plate	Polished Chrome	---	\$39.00
	X-4200001	Retainer Cap	Polished Chrome	---	\$7.40
	X-4400080	Retainer Nut	---	---	\$4.35
	X-4400030	Sleeve	Polished Chrome	---	\$23.35
	X-3400007	Ceramic Disc Cartridge	---	---	\$49.00
	X-4900024	Allen Wrench	---	---	\$1.30
	X-6400086	1/2" Combo Diverter Tub Spout	Polished Chrome	---	\$80.25
	OP-640043	7" Extended Diverter Tub Spout	Polished Chrome	---	\$89.00
	X-4900080	Allen Screw	---	---	\$1.30

Low flow showerheads available upon request.
See page 3 for special order finish options.

Pioneer showerheads meet ANSI/ASME A112.18.1 flow requirements of maximum 1.75 GPM

MOD // Tub & Shower

HANDHELD SHOWER SETS

	Model#	Description	Finish	Case	Price
	6MO400	Handheld Shower Set Single Function Handheld Showerhead	Polished Chrome	6	\$349.00
	6MO400-BN	30" Slide Bar with Brass Mounts 60" Stainless Steel Flex Hose Brass Drop Ell with Vacuum Breaker With 1.75 GPM Flow Rate	PVD Brushed Nickel	6	\$439.00
	4MO400T	Single Handle Valve Trim Set Metal Lever Handle	Polished Chrome	6	\$96.00
	4MO400T-BN	Ceramic Disc Cartridge with Temperature Limit Stop Color Match Sleeve and Retaining Ring For Use with 4020B Valve - Valve not included	PVD Brushed Nickel	6	\$119.70
	6MO101T	Single Handle Diverter Trim Set Metal Lever Handle	Polished Chrome	6	\$82.00
	6MO101T-BN	Diverter Valve Face Plate Diverter Valve Sleeve For Use with 4100B Valve - Valve not included	PVD Brushed Nickel	6	\$92.00
PARTS	X-4400106	Handheld Showerhead	Polished Chrome	---	\$78.75
	X-4600005	Vacuum Breaker	Polished Chrome	---	\$14.50
	X-4600058	Drop Ell	Polished Chrome	---	\$102.00
	X-4600059	Mounting Kit	---	---	\$109.00
	OP-460025	Washer	---	---	\$1.50
	OP-460027	60" Stainless Steel Flex Hose	Polished Chrome	---	\$22.00



See page 3 for special order finish options.

Pioneer showerheads meet ANSI/ASME A112.18.1 flow requirements of maximum 1.75 GPM

MOD

MOD // Tub & Shower

TWO HANDLE ROMAN TUB SETS





	Model#	Description	Finish	Case	Price
	4MO610T	Two Handle Roman Tub Trim Set Metal Lever Handle	Polished Chrome	6	\$369.90
	4MO610T-BN	Rigid Spout 6-5/8" Reach 3-Hole 8" to 16" Installation For Use with 4300B Valve - Valve not included	PVD Brushed Nickel	6	\$465.40
	4MO611	Two Handle Roman Tub Set With Handheld Showerhead Metal Lever Handle	Polished Chrome	4	\$730.80
	4MO611-BN	Rigid Spout 6-5/8" Reach Ceramic Disc Cartridges 4-Hole 8" to 16" Installation Includes Integral Diverter Valve Single Function Handheld Showerhead With 1.75 GPM Flow Rate	PVD Brushed Nickel	4	\$921.70
PARTS	X-1400044	Metal Lever Handle	Polished Chrome	---	\$32.50
	X-2400019	Rigid Spout	Polished Chrome	---	\$333.29
	X-2400020	Rigid Diverter Spout	Polished Chrome	---	\$385.00
	X-3400004	Diverter Valve	---	---	\$121.66
	X-3900002C	Ceramic Disc Cartridge-Cold	---	---	\$10.70
	X-3900002H	Ceramic Disc Cartridge-Hot	---	---	\$10.70
	X-4400028	Allen Screw	---	---	\$1.30
	X-4400058	5/16" Allen Wrench	---	---	\$0.80
	X-4400063	Flex Hose Connector	---	---	\$13.45
	X-4400073	Hole Cover	Polished Chrome	---	\$3.05
	X-4400102	Flow Streamer	Polished Chrome	---	\$4.85
	X-4400108	Valve Escutcheon & Sleeve	Polished Chrome	---	\$25.50
	X-4400109	Spout Escutcheon	Polished Chrome	---	\$30.00
	X-4400106	Handheld Showerhead	Polished Chrome	---	\$78.75
	X-4400113	Pull Rod Flange	Polished Chrome	---	\$11.25
	X-4400114	Diverter Pull Rod	Polished Chrome	---	\$9.75
	X-4600006	Handheld Showerhead Hose	Polished Chrome	---	\$120.00
	X-4900002	3/32" Allen Screw	---	---	\$1.30
	X-4900004	Supply Nut	---	---	\$3.30
	X-4900022	Bonnet Nut	---	---	\$4.35
	X-4900024	3/32" Allen Wrench	---	---	\$1.30
	X-4900044	Hole Cover	Polished Chrome	---	\$2.05
	X-4900047	Washer	---	---	\$1.30
	X-5400003	Mounting Kit	---	---	\$16.75
	X-5600004	Mounting Kit	---	---	\$3.85
X-4400028	5/16" Allen Screw	---	---	\$1.30	

See page 3 for special order finish options.

Pioneer showerheads meet ANSI/ASME A112.18.1 flow requirements of maximum 1.75 GPM

MOD // Bathroom Hardware

BATHROOM HARDWARE

	Model#	Description	Finish	Case	Price
	7MO030	Towel Bar 24" Long	Polished Chrome	20	\$72.00
	7MO030-BN	Concealed Screw Installation Mounting Hardware	PVD Brushed Nickel	20	\$93.00
	7MO030-MB		Matte Black	20	\$86.00
	7MO031	Towel Bar 18" Long	Polished Chrome	20	\$69.30
	7MO031-BN	Concealed Screw Installation Mounting Hardware	PVD Brushed Nickel	20	\$90.30
	7MO031-MB		Matte Black	20	\$83.00
	7MO032	Toilet Tissue Holder	Polished Chrome	40	\$47.80
	7MO032-BN	Concealed Screw Installation Mounting Hardware	PVD Brushed Nickel	40	\$60.40
	7MO032-MB		Matte Black	40	\$57.50
	7MO033	Robe Hook	Polished Chrome	40	\$32.60
	7MO033-BN	Concealed Screw Installation Mounting Hardware	PVD Brushed Nickel	40	\$38.90
	7MO033-MB		Matte Black	40	\$39.00
	7MO034	Towel Ring	Polished Chrome	40	\$43.60
	7MO034-BN	Concealed Screw Installation Mounting Hardware	PVD Brushed Nickel	40	\$56.70
	7MO034-MB		Matte Black	40	\$52.50

See page 3 for special order finish options.

MOD

MOTEGI // Kitchen Faucets

SINGLE HANDLE KITCHEN PULL-DOWN FAUCETS







	Model#	Description	Finish	Case	Price
	 2MT250	Single Handle Pull-Down Kitchen Faucet Metal Lever Handle	Polished Chrome	6	\$425.00
	2MT250-BN	Pull-Down Head with 2 Spray Patterns Swivel 360° 8-9/16" Reach, 10-1/16" from Deck to Aerator	PVD Brushed Nickel	6	\$469.00
	2MT250-SS	Ceramic Disc Cartridge with Temperature Limit Stop 1 or 3 Hole 8" Installation Easy-Install 30" Flex Supply Lines With 3/8" Connections Ball Joint Swivel Sprayhead Quick Connect Spray Head Hose and Weight, Easy-in- install mounting nut With 1.8 GPM Flow Rate	PVD Stainless Steel	6	\$469.00
	2MT250-E1.5	With 1.5 GPM Flow Rate	Polished Chrome	6	\$427.00
	2MT251	Same as Above with 1 Hole Installation Option Only	Polished Chrome	6	\$394.00
	2MT251-BN		PVD Brushed Nickel	6	\$434.00
		 2MT260	Single Handle Pull-Down Kitchen Faucet Metal Lever Handle	Polished Chrome	6
2MT260-BN		Pull-Down Head with 2 Spray Patterns Swivel 360° 8-9/16" Reach, 9-15/16" from Deck to Aerator	PVD Brushed Nickel	6	\$492.00
2MT260-MB		Ceramic Disc Cartridge with Temperature Limit Stop 1 or 3 Hole 8" Installation Ball Joint Swivel Sprayhead Easy-Install 30" Flex Supply Lines With 3/8" Connections Quick Connect Spray Head Hose and Weight, Easy-in- install mounting nut With 1.8 GPM Flow Rate	Matte Black	6	\$521.00
2MT260-E1.5		With 1.5 GPM Flow Rate	Polished Chrome	6	\$449.00
2MT260-E1.5-BN			PVD Brushed Nickel	6	\$494.00
2MT261		Same as Above with 1 Hole Installation Option Only	Polished Chrome	6	\$416.00
2MT261-E1.5		With 1.5 GPM Flow Rate	Polished Chrome	6	\$419.00
	 2MT270	Single Handle Pull-Down Pre-Rinse Kitchen Faucet Metal Lever Handle	Polished Chrome	4	\$465.00
	2MT270-BN	Pull-Down Head with 2 Spray Patterns Swivel 360° 9" Reach, 7" from Deck to Aerator	PVD Brushed Nickel	4	\$555.00
	2MT270-MB	22-3/4" Overall Height Ceramic Disc Cartridge with Temperature Limit Cap 1-Hole Installation Optional 3-Hole 8" Deck Plate Available Easy-Install 30" Flex Supply Lines With 3/8" Connections Quick Connect Spray Head Hose and Weight, Easy-in- install mounting nut With 1.8 GPM Flow Rate	Matte Black	4	\$582.75
	 2MT275	Single Handle Pull-Down Pre-Rinse Kitchen Faucet Metal Lever Handle	Polished Chrome	4	\$449.00
	2MT275-BN	Pull-Down Head with 2 Spray Patterns Swivel 360° 9" Reach, 7" from Deck to Aerator 19-3/4" Overall Height Ceramic Disc Cartridge with Temperature Limit Cap 1-Hole Installation Optional 3-Hole 8" Deck Plate Available Easy-Install 30" Flex Supply Lines With 3/8" Connections Quick Connect Spray Head Hose and Weight, Easy-in- install mounting nut With 1.8 GPM Flow Rate	PVD Brushed Nickel	4	\$536.00

Low flow aerators available upon request.
See page 3 for special order finish options.

Pioneer faucets feature aerators that meet ANSI/ASME A112.18.1 flow requirements of 1.8 GPM

MOTEGI // Kitchen Faucets

SINGLE HANDLE KITCHEN FAUCETS

		Model#	Description	Finish	Case	Price
		2MT161H	Single Handle Kitchen Faucet Metal Lever Handle	Polished Chrome	6	\$370.00
		2MT161H-BN	Bent Nose Spout Swivel 360° 8-1/2" Reach, 6-7/16" from Deck to Aerator Ceramic Disc Cartridge with Temperature Limit Stop 2-Hole Installation Side Spray Assembly Easy-Install 30" Flex Supply Lines With 3/8" Connections With 1.5 GPM Flow Rate	PVD Brushed Nickel	6	\$396.00
		2MT171H	Single Handle Kitchen Faucet Metal Lever Handle	Polished Chrome	6	\$396.00
		2MT171H-BN	Gooseneck Spout Swivel 360° 7-5/8" Reach, 8-1/2" from Deck to Aerator Ceramic Disc Cartridge with Temperature Limit Stop 2-Hole Installation Side Spray Assembly Easy-Install 30" Flex Supply Lines With 3/8" Connections With 1.5 GPM Flow Rate	PVD Brushed Nickel	6	\$427.00
		2MT182H	Single Handle Kitchen Faucet Metal Lever Handle	Polished Chrome	6	\$292.00
		2MT182H-BN	90 Degree Spout Swivel 360° 8" Reach, 9" from Deck to Aerator Ceramic Disc Cartridge with Temperature Limit Stop 2-Hole Installation Side Spray Assembly Easy-Install 30" Flex Supply Lines With 3/8" Connections With 1.5 GPM Flow Rate	PVD Brushed Nickel	6	\$325.00

Low flow aerators available upon request.
See page 3 for special order finish options.

Pioneer faucets feature aerators that meet ANSI/ASME A112.18.1 flow requirements of 1.5 GPM

MOTEGI

MOTEGI // Kitchen Faucets





POT FILLERS

	Model#	Description	Finish	Case	Price
	2MT600	Wall Mount Pot Filler	Polished Chrome	6	\$376.00
	2MT600-BN	Metal Lever Handles	PVD Brushed Nickel	6	\$402.00
	2MT600-SS	Space Saving Swivel Spout folds in when not in use 23-9/16" Spout Reach Ceramic Disc Cartridges 1-Hole Wall Mount Installation Designed for Cold Water 1/2" IPS Connection with Flange With 2.0 GPM Flow Rate	PVD Stainless Steel	6	\$402.00
PARTS	X-1200011	Handle Set	Polished Chrome	---	\$22.35
	X-1200012	Handle Set	Polished Chrome	---	\$24.40
	X-1200018	Handle Set	Polished Chrome	---	\$31.50
	X-1200019	Secondary Handle Set	Polished Chrome	---	\$26.40
	X-1900008	Handle Set	Polished Chrome	---	\$22.35
	X-2200014	Gooseneck Spout Set	Polished Chrome	---	\$179.00
	X-2200015	90 Degree Spout Set	Polished Chrome	---	\$192.00
	X-2200017	Gooseneck Spout Set	Polished Chrome	---	\$179.00
	X-2200018	Bent Nose Spout Set	Polished Chrome	---	\$79.00
	X-2200019	Gooseneck Spout Set	Polished Chrome	---	\$99.00
	X-3200001	Ceramic Disc Cartridge	---	---	\$16.00
	X-3200004H	Ceramic Stem-Hot	---	---	\$24.40
	X-3900001	Ceramic Disc Cartridge With Temperature Limit Stop	---	---	\$13.20
	X-4200007	Diverter Piston	---	---	\$2.30
	X-4200016	Diverter Piston	---	---	\$8.09
	X-4200070	Side Spray	Polished Chrome	---	\$185.99
	X-4200180	Spray Head-1.8 GPM	Polished Chrome	---	\$57.17
	X-4900089	Aerator-1.5 GPM-Male	Polished Chrome	---	\$6.60
	X-4900072	Aerator-1.0 GPM-Male	Polished Chrome	---	\$7.65
	X-4900073	Aerator-0.5 GPM-Male	Polished Chrome	---	\$14.75
X-4200181	Spray Head-1.8 GPM	Polished Chrome	---	\$ 49.00	

See page 3 for special order finish options.

MOTEGI // Lavatory Faucets

SINGLE HANDLE LAVATORY FAUCETS

	Model#	Description	Finish	Case	Price
	3MT161	Single Handle Lavatory Faucet Metal Lever Handle	Polished Chrome	6	\$185.00
	3MT161-BN	Bent Nose Spout 5-5/8" Reach, 1-3/4" from Deck to Aerator Ceramic Disc Cartridge with Temperature Limit Stop 1-Hole Installation Easy-Install 18" Flex Supply Lines With 3/8" Connections With 1.2 GPM Flow Rate	PVD Brushed Nickel	6	\$197.00
	3MT161-E1.0	With 1.0 GPM Flow Rate	Polished Chrome	6	\$188.00
	3MT161-E1.0-BN		PVD Brushed Nickel	6	\$200.00
	3MT161G	Single Handle Lavatory Faucet Metal Lever Handle	Polished Chrome	6	\$210.00
	3MT161G-BN	Bent Nose Spout 5-5/8" Reach, 1-3/4" from Deck to Aerator Ceramic Disc Cartridge with Temperature Limit Stop 1-Hole Installation Easy-Install 18" Flex Supply Lines With 3/8" Connections Brass Grid Strainer Drain Assembly With 1.2 GPM Flow Rate	PVD Brushed Nickel	6	\$222.00
	3MT160	Single Handle Lavatory Faucet Metal Lever Handle	Polished Chrome	6	\$218.00
	3MT160-BN	Bent Nose Spout	PVD Brushed Nickel	6	\$226.00
	3MT160-MB	5-5/8" Reach, 1-3/4" from Deck to Aerator Ceramic Disc Cartridge with Temperature Limit Stop 1-Hole Installation	Matte Black	6	\$238.00
	3MT160B*	Easy-Install 18" Flex Supply Lines With 3/8" Connections Brass Pop-Up Drain Assembly With 1.2 GPM Flow Rate *Builder Tract Pack	Polished Chrome	6	\$216.00
	3MT160-E0.5	With 0.5 GPM Flow Rate	Polished Chrome	6	\$221.00
	3MT160-E0.5-BN		PVD Brushed Nickel	6	\$229.00
	3MT160-E1.0	With 1.0 GPM Flow Rate	Polished Chrome	6	\$223.00
	3MT168	Single Handle Lavatory Faucet Metal Lever Handle	Polished Chrome	6	\$248.00
	3MT168-BN	Bent Nose Spout 5-5/8" Reach, 9-3/4" from Deck to Aerator Ceramic Disc Cartridge with Temperature Limit Stop 1-Hole Installation Easy-Install 18" Flex Supply Lines With 3/8" Connections With 1.2 GPM Flow Rate	PVD Brushed Nickel	6	\$260.00





Builder Tract Packs sold in case quantities only.
Low flow aerators available upon request.
See page 3 for special order finish options.

Pioneer faucets feature aerators that meet ANSI/ASME A112.18.1 flow requirements of 1.2 GPM

MOTEGI

MOTEGI // Lavatory Faucets

SINGLE HANDLE LAVATORY FAUCETS



	Model#	Description	Finish	Case	Price
	3MT170	Single Handle Lavatory Faucet Metal Lever Handle	Polished Chrome	6	\$218.00
	3MT170-BN	Straight Spout	PVD Brushed Nickel	6	\$226.00
	3MT170-MB	3-3/4" Reach, 2-7/8" from Deck to Aerator Ceramic Disc Cartridge with Temperature Limit Stop	Matte Black	6	\$248.00
	3MT170B*	1-Hole Installation Easy-Install 18" Flex Supply Lines With 3/8" Connections Brass Pop-Up Drain Assembly With 1.2 GPM Flow Rate *Builder Tract Pack	Polished Chrome	6	\$216.00
	3MT170-E0.5	With 0.5 GPM Flow Rate	Polished Chrome	6	\$221.00
	3MT170-E0.5-BN		PVD Brushed Nickel	6	\$229.00
	3MT170-E1.0	With 1.0 GPM Flow Rate	Polished Chrome	6	\$221.00
	3MT170-E1.0-BN		PVD Brushed Nickel	6	\$229.00
	3MT178	Single Handle Lavatory Faucet Metal Lever Handle Straight Spout 3-3/4" Reach, 10-7/8" from Deck to Aerator Ceramic Disc Cartridge with Temperature Limit Stop 1-Hole Installation Easy-Install 18" Flex Supply Lines With 3/8" Connections With 1.2 GPM Flow Rate	Polished Chrome	6	\$248.00
	3MT180	Single Handle Lavatory Faucet Metal Lever Handle	Polished Chrome	6	\$318.00
	3MT180-BN	Gooseneck Spout Swivel 90°	PVD Brushed Nickel	6	\$334.00
	3MT180-MB	5-1/2" Reach, 8-1/2" from Deck to Aerator Ceramic Disc Cartridge with Temperature Limit Stop 1-Hole Installation Brass Pop-Up Drain Assembly Easy-Install 18" Flex Supply Lines With 3/8" Connections With 1.2 GPM Flow Rate	Matte Black	6	\$348.00
	3MT800*	Single Handle Lavatory Wall Mount Vessel Filler Metal Lever Handle	Polished Chrome	6	\$263.70
	3MT800-BN*	Bent Nose Spout 10" Reach	PVD Brushed Nickel	6	\$271.00
	3MT800-MB	Ceramic Disc Cartridge with Temperature Limit Stop 2-Hole 4" Installation Includes Valve with Mounting Plate With 1.2 GPM Flow Rate *1" Extension Kit available X-4900125, X-4900125-BN	Matte Black	6	\$282.00
	3MT800-E1.0	With 1.0 GPM Flow Rate	Polished Chrome	6	\$266.00

Low flow aerators available upon request.
See page 3 for special order finish options.

Pioneer faucets feature aerators that meet ANSI/ASME A112.18.1 flow requirements of 1.5 GPM

MOTEGI // Lavatory Faucets

TWO HANDLE LAVATORY FAUCETS

	Model#	Description	Finish	Case	Price
	3MT500	Two Handle Lavatory Widespread Faucet Metal Lever Handles	Polished Chrome	6	\$381.00
	3MT500-BN	Bent Nose Spout 6-1/2" Reach, 1-3/4" from Deck to Aerator Ceramic Disc Cartridges 3-Hole 6" to 16" Installation Brass Pop-Up Drain Assembly Includes Spout and Valve Escutcheons With 1.2 GPM Flow Rate	PVD Brushed Nickel	6	\$402.00
	3MT420	Two Handle Lavatory Widespread Faucet Metal Lever Handles	Polished Chrome	6	\$320.00
	3MT420-BN	90 Degree Spout 5-1/2" Reach, 2-1/2" from Deck to Aerator Ceramic Disc Cartridges 3-Hole 6" to 16" Installation Brass Pop-Up Drain Assembly With 1.2 GPM Flow Rate	PVD Brushed Nickel	6	\$352.00
	3MT400	Two Handle Lavatory Widespread Faucet Metal Lever Handles	Polished Chrome	6	\$381.00
	3MT400-BN	Gooseneck Spout Swivel 90° 5-1/2" Reach, 7" from Deck to Aerator Ceramic Disc Cartridges 3-Hole 6" to 16" Installation Brass Pop-Up Drain Assembly With 1.2 GPM Laminar Flow Rate	PVD Brushed Nickel	6	\$402.00
	3MT400-E1.0	With 1.0 GPM Flow Rate	Polished Chrome	6	\$384.00
PARTS	X-1300006	Handle Set	Polished Chrome	---	\$18.55
	X-1900008	Handle Set	Polished Chrome	---	\$22.35
	X-2300004	Gooseneck Spout Set	Polished Chrome	---	\$158.00
	X-2300005	Bent Nose Spout Set	Polished Chrome	---	\$81.00
	X-2300006	Gooseneck Spout Set	Polished Chrome	---	\$88.00
	X-3900001	Ceramic Disc Cartridge With Temperature Limit Stop	---	---	\$13.20
	X-3900002C	Ceramic Stem-Cold	---	---	\$10.70
	X-3900002H	Ceramic Stem-Hot	---	---	\$10.70
	X-4300022	8" Extension Base	Polished Chrome	---	\$90.00
	X-4300043	Brass Pop-Up	Polished Chrome	---	\$45.00
	X-6300002	Brass Grid Strainer	Polished Chrome	---	\$51.00
	X-6300006	Brass Pop-Up	Polished Chrome	---	\$39.00
	X-4900125	1" Extension Kit (For 3MT800)	Polished Chrome	---	\$42.00
	X-4900125-BN	1" Extension Kit (For 3MT800-BN)	PVD Brushed Nickel	---	\$49.00
	X-4900041	Aerator-2.0 GPM-Male	Polished Chrome	---	\$4.85
	X-4900072	Aerator-1.0 GPM-Male	Polished Chrome	---	\$7.65
	X-4900073	Aerator-0.5 GPM-Male	Polished Chrome	---	\$14.75
	X-4900089	Aerator-1.5 GPM-Male	Polished Chrome	---	\$6.60













Low flow aerators available upon request.
See page 3 for special order finish options.

Pioneer faucets feature aerators that meet ANSI/ASME A112.18.1 flow requirements of 1.5 GPM

MOTEGI

MOTEGI // Tub & Shower

TUB & SHOWER TRIM SETS





	Model#	Description	Finish	Case	Price
	 4MT110T	Single Handle Tub and Shower Trim Set Metal Lever Handle	Polished Chrome	6	\$376.00
	 4MT110T-BN	Ceramic Disc Cartridge with Temperature Limit Stop	PVD Brushed Nickel	6	\$396.00
	4MT110T-MB	Five Function 3" Diameter Showerhead Shower Arm and Flange	Matte Black	6	\$406.00
	 4MT110T-LS*	1/2" IPS Diverter Tub Spout 7-1/4" Spout Reach Color Match Sleeve and Retaining Ring With 1.75 GPM Flow Rate For Use with 4020B Valve - Valve not included *Less Showerhead	Polished Chrome	6	\$322.00
	 4MT200T	Single Handle Tub Trim Set Metal Lever Handle	Polished Chrome	6	\$287.00
	4MT200T-BN	Ceramic Disc Cartridge with Temperature Limit Stop 1/2" IPS Tub Spout with Escutcheon 6-1/8" Spout Reach Color Match Sleeve and Retaining Ring For Use with 4020B Valve - Valve not included	PVD Brushed Nickel	6	\$308.00
	4MT201T	Combo 1/2" IPS/Slip-On Tub Spout With Escutcheon, 7" Spout Reach	Polished Chrome	6	\$227.50
	4MT201T-BN		PVD Brushed Nickel	6	\$260.00
	 4MT300T	Single Handle Shower Trim Set Metal Lever Handle	Polished Chrome	6	\$229.50
	 4MT300T-BN	Ceramic Disc Cartridge with Temperature Limit Stop	PVD Brushed Nickel	6	\$297.00
	4MT300T-MB	Five Function 3" Diameter Showerhead Shower Arm and Flange Color Match Sleeve and Retaining Ring With 1.75 GPM Flow Rate For Use with 4020B Valve - Valve not included	Matte Black	6	\$317.00
	4MT300T-E1.5	With 1.5 GPM Flow Rate	Polished Chrome	6	\$232.50
	 4MT120T	Single Handle Tub and Shower Trim Set Metal Lever Handle	Polished Chrome	6	\$349.00
	 4MT120T-BN	Ceramic Disc Cartridge with Temperature Limit Stop Single Function 3-3/8" Diameter Showerhead Shower Arm and Flange 1/2" IPS Diverter Tub Spout 7-1/4" Spout Reach Color Match Sleeve and Retaining Ring With 1.75 GPM Flow Rate For Use with 4020B Valve - Valve not included	PVD Brushed Nickel	6	\$370.00

Low flow showerheads available upon request.
See page 3 for special order finish options.

Pioneer showerheads meet ANSI/ASME A112.18.1 flow requirements of maximum 1.75 GPM

MOTEGI // Tub & Shower

TUB & SHOWER TRIM SETS

	Model#	Description	Finish	Case	Price
	4MT320T	Single Handle Shower Trim Set Metal Lever Handle	Polished Chrome	6	\$194.00
	4MT320T-BN	Ceramic Disc Cartridge with Temperature Limit Stop Single Function 3-3/8" Diameter Showerhead Shower Arm and Flange Color Match Sleeve and Retaining Ring With 1.75 GPM Flow Rate For Use with 4020B Valve - Valve not included	PVD Brushed Nickel	6	\$271.00
	4MT115T	Single Handle Tub and Shower Trim Set Metal Lever Handle	Polished Chrome	6	\$479.00
	4MT115T-BN	Ceramic Disc Cartridge with Temperature Limit Cap Single Function 8" Diameter Rain Showerhead 15" L Shape Shower Arm And Shower Arm Flange 1/2" IPS Diverter Tub Spout, 7-1/4" Spout Reach Color Match Sleeve and Retaining Ring With 2.5 GPM Flow Rate For Use with 4020B Valve - Valve not included	PVD Brushed Nickel	6	\$619.00
	4MT315T	Single Handle Shower Trim Set Metal Lever Handle Ceramic Disc Cartridge with Temperature Limit Stop Single Function 8" Diameter Rain Showerhead 15" L Shape Shower Arm And Shower Arm Flange Color Match Sleeve and Retaining Ring With 2.5 GPM Flow Rate For Use with 4020B Valve - Valve not included	Polished Chrome	6	\$319.00
	4MT111T	Single Handle Tub and Shower Trim Set Metal Lever Handle	Polished Chrome	6	\$264.00
	4MT111T-E1.5*	Ceramic Disc Cartridge with Temperature Limit Stop Five Function 3" Diameter Showerhead Shower Arm and Flange Combo 1/2" IPS/Slip-On Diverter Tub Spout, 7" Spout Reach Color Match Sleeve and Retaining Ring With 1.75 GPM Flow Rate For Use with 4020B Valve - Valve not included *With 1.5 GPM Flow Rate	Polished Chrome	6	\$214.00
	4MT111T-LS	Less Showerhead	Polished Chrome	6	\$267.00

Low flow showerheads available upon request.
See page 3 for special order finish options.





Pioneer showerheads meet ANSI/ASME A112.18.1 flow requirements of maximum 1.75 GPM

MOTEGI

MOTEGI // Tub & Shower

NEW SHOWERS

TUB & SHOWER TRIM SETS



	Model#	Description	Finish	Case	Price
	4MT131T	Single Function 6" Diameter Rain Showerhead Shower Arm and Flange	Polished Chrome	6	\$299.00
	4MT131T-BN	Combo 1/2" IPS/Slip-On Dvr. Tub Spout With Escutcheon, 7" Spout Reach Color Match Sleeve and Retaining Ring With 1.75 GPM Flow Rate For Use with 4020B Valve - Valve not included	PVD Brushed Nickel	6	\$323.00
	4MT330T	Single Handle Shower Trim Set Metal Lever Handle	Polished Chrome	6	\$239.00
	4MT330T-BN	Ceramic Disc Cartridge with Temperature Limit Cap Single Function 6" Diameter Rain Showerhead Shower Arm and Flange Color Match Sleeve and Retaining Ring With 1.75 GPM Flow Rate For Use with 4020B Valve - Valve not included	PVD Brushed Nickel	6	\$295.00
	4MT330T-E1.5	With 1.5 GPM Flow Rate	Polished Chrome	6	\$242.00
	4MT400T	Single Handle Valve Trim Set Metal Lever Handle	Polished Chrome	6	\$183.00
	4MT400T-BN	Ceramic Disc Cartridge with Temperature Limit Stop Color Match Sleeve and Retaining Ring For Use with 4020B Valve - Valve not included	PVD Brushed Nickel	6	\$203.00
	6MT101T	Single Handle Diverter Trim Set Metal Lever Handle	Polished Chrome	12	\$78.00
	6MT101T-BN	Diverter Valve Face Plate Diverter Valve Sleeve For Use with 4100B Valve - Valve not included	PVD Brushed Nickel	12	\$87.00
PARTS	X-1400028	Handle Set	Polished Chrome	---	\$37.00
	X-1600001	Diverter Handle Set	Polished Chrome	---	\$31.50
	X-4400043	Face Plate	Polished Chrome	---	\$80.00
	X-4600011	Diverter Valve Flange Set	Polished Chrome	---	\$40.00
	X-6400019	Single Function Showerhead	Polished Chrome	---	\$30.45
	X-6400011	Shower Arm Flange	Polished Chrome	---	\$15.00
	X-6400024	Tub Spout	Polished Chrome	---	\$96.00
	X-6400051	Diverter Tub Spout	Polished Chrome	---	\$202.00
	X-6400012	Rain Showerhead	Polished Chrome	---	\$202.00
	X-6400095	3" Five Function Showerhead	Polished Chrome	---	\$60.00
	X-6400083	6" Rain Showerhead (1.75 GPM)	Polished Chrome	---	\$65.00
	X-6400002	Shower Arm	Polished Chrome	---	\$13.20
	X-6400081	Showerhead	Polished Chrome	---	\$25.40
	X-6400102	Extended Diverter Tub Spout	Polished Chrome	---	\$38.00
	X-4400105	Escutcheon	Polished Chrome	---	\$23.00

Low flow showerheads available upon request.
See page 3 for special order finish options.

Pioneer showerheads meet ANSI/ASME A112.18.1 flow requirements of maximum 2.5 GPM

MOTEGI // Tub & Shower

HANDHELD SHOWER SETS

	Model#	Description	Finish	Case	Price
	6MT400	Handheld Shower Set Single Function Handheld Showerhead	Polished Chrome	6	\$412.00
	6MT400-BN	25" Slide Bar with Brass Mounts 60" Stainless Steel Flex Hose Brass Drop Ell with Vacuum Breaker With 1.75 GPM Flow Rate	PVD Brushed Nickel	6	\$427.00
	6MT410	Handheld Shower Set Single Function Handheld Showerhead	Polished Chrome	6	\$198.00
	6MT410-BN	60" Stainless Steel Flex Hose Wall Mount Bracket with Vacuum Breaker With 1.75 GPM Flow Rate	PVD Brushed Nickel	6	\$209.00
PARTS	X-4600003	Handheld Shower Slide Bar and slider	Polished Chrome	---	\$99.00
	X-4600006	Handheld Shower Hose	Polished Chrome	---	\$120.00
	X-4600015	Handheld Shower Drop Ell	Polished Chrome	---	\$59.00
	X-4600016	Handheld Shower Slide Bar Brass Mount	Polished Chrome	---	\$90.00
	X-4600031	Drop Ell With Handheld Support	Polished Chrome	---	\$56.00
	X-4600032	Flange	Polished Chrome	---	\$20.05
	X-4900112	Handheld Shower-1.75 GPM	Polished Chrome	---	\$91.49

Low flow showerheads available upon request.
See page 3 for special order finish options.

Pioneer showerheads meet ANSI/ASME A112.18.1 flow requirements of maximum 1.75 GPM

MOTEGI

MOTEGI // Tub & Shower

TWO HANDLE ROMAN TUB SETS

	Model#	Description	Finish	Case	Price
	4MT610	Two Handle Roman Tub Set Metal Lever Handles	Polished Chrome	4	\$444.00
	4MT610-BN	Rigid Bent Nose Spout 9-3/8" Reach Ceramic Disc Cartridges 3-Hole 8" to 16" Installation Includes Spout and Valve Escutcheons	PVD Brushed Nickel	4	\$464.00

SINGLE HANDLE ROMAN TUB SETS





	Model#	Description	Finish	Case	Price
	4MT840*	Single Handle Wall Mount Roman Tub Set Metal Lever Handle	Polished Chrome	6	\$313.00
	4MT840-BN*	Rigid Bent Nose Spout 10" Reach Ceramic Disc Cartridge with Temperature Limit Stop 2-Hole 4" Installation Includes Valve with Mounting Plate *1" Extension Kit available X-4900125, X-4900125-BN	PVD Brushed Nickel	6	\$329.00

PARTS	Model#	Description	Finish	Case	Price
	X-1400006	Handle Set	Polished Chrome	---	\$42.00
	X-1900008	Handle Set	Polished Chrome	---	\$22.35
	X-2400001	Spout Set	Polished Chrome	---	\$103.00
	X-2400007	Bent Nose Spout Set	Polished Chrome	---	\$215.00
	X-3900001	Ceramic Disc Cartridge With Temperature Limit Stop	---	---	\$13.20
	X-3900002C	Ceramic Stem-Cold	---	---	\$10.70
	X-3900002H	Ceramic Stem-Hot	---	---	\$10.70
	X-2400021	Spout Set	Polished Chrome	---	\$130.00
	X-4900125	1" Extension Kit (For 4MT840)	Polished Chrome	---	\$42.00
X-4900125-BN	1" Extension Kit (For 4MT840-BN)	PVD Brushed Nickel	---	\$49.00	

See page 3 for special order finish options.

MOTEGI // Bathroom Hardware

BATHROOM HARDWARE



	Model#	Description	Finish	Case	Price
	7MT030	Towel Bar 24" Long	Polished Chrome	20	\$120.00
	7MT030-BN	Brass Mount Concealed Screw Installation Mounting Hardware	PVD Brushed Nickel	20	\$127.00
	7MT031	Towel Bar 18" Long	Polished Chrome	20	\$110.00
	7MT031-BN	Brass Mount Concealed Screw Installation Mounting Hardware	PVD Brushed Nickel	20	\$117.00
	7MT032	Toilet Tissue Holder	Polished Chrome	40	\$63.00
	7MT032-BN	Brass Mount Concealed Screw Installation Mounting Hardware	PVD Brushed Nickel	40	\$67.00
	7MT033	Robe Hook	Polished Chrome	40	\$63.00
	7MT033-BN	Brass Mount Concealed Screw Installation Mounting Hardware	PVD Brushed Nickel	40	\$67.00
	7MT034	Towel Ring	Polished Chrome	40	\$63.00
	7MT034-BN	Brass Mount Concealed Screw Installation Mounting Hardware	PVD Brushed Nickel	40	\$67.00

See page 3 for special order finish options.

MOTEGI

LEGACY // Kitchen Faucets

SINGLE HANDLE KITCHEN FAUCETS



	Model#	Description	Finish	Case	Price
	2LG160	Single Handle Kitchen Faucet Metal Lever Handle Spout Swivel 360° 9-11/16" Reach, 5-7/8" from Deck to Aerator Ceramic Disc Cartridge with Temperature Limit Stop 3-Hole 8" Installation With 1.5 GPM Flow Rate	Polished Chrome	12	\$142.00
	2LG160B	Builder Tract Pack	Polished Chrome	12	\$140.00
	2LG160H	30" SS Flex Connectors with 3/8" Compression Connection Nuts	Polished Chrome	12	\$144.00
	2LG160H-BN		PVD Brushed Nickel	12	\$156.00
	2LG160-E0.5	With 0.5 GPM Flow Rate	Polished Chrome	12	\$145.00
	2LG160-E1.0	With 1.0 GPM Flow Rate	Polished Chrome	12	\$145.00
	2LG161	Single Handle Kitchen Faucet Metal Lever Handle Spout Swivel 360° 9-11/16" Reach, 5-7/8" from Deck to Aerator Ceramic Disc Cartridge with Temperature Limit Stop 4-Hole 8" Installation Side Spray Assembly With 1.5 GPM Flow Rate	Polished Chrome	12	\$174.00
	2LG161-BN		PVD Brushed Nickel	12	\$189.00
	2LG161B	Builder Tract Pack	Polished Chrome	12	\$172.00
	2LG161B-BN		PVD Brushed Nickel	12	\$187.00
	2LG161H	30" SS Flex Connectors with 3/8" Compression Connection Nuts	Polished Chrome	12	\$176.00
	2LG161H-BN		PVD Brushed Nickel	12	\$191.00
	2LG161H-E0.5	With 0.5 GPM Flow Rate	Polished Chrome	12	\$176.00
	2LG162	Single Handle Kitchen Faucet Metal Lever Handle Spout Swivel 360° 9-11/16" Reach, 5-7/8" from Deck to Aerator Ceramic Disc Cartridge with Temperature Limit Stop 3-Hole 8" Installation Side Spray Assembly on Deck With 1.5 GPM Flow Rate	Polished Chrome	12	\$178.00

Builder Tract Packs sold in case quantities only.
Low flow aerators available upon request.
See page 3 for special order finish options.

Pioneer faucets feature aerators that meet ANSI/ASME A112.18.1 flow requirements of 1.5 GPM

LEGACY // Kitchen Faucets

SINGLE HANDLE KITCHEN FAUCETS

	Model#	Description	Finish	Case	Price
	2LG260	Single Handle Kitchen Faucet Metal Lever Handle	Polished Chrome	12	\$144.00
	2LG260-BN	Spout Swivel 360° 9-11/16" Reach, 5-7/8" from Deck to Aerator Ceramic Disc Cartridge with Temperature Limit Stop 1-Hole Installation With 1.5 GPM Flow Rate	PVD Brushed Nickel	12	\$155.00
	2LG261	Single Handle Kitchen Faucet Metal Lever Handle Spout Swivel 360° 9-11/16" Reach, 5-7/8" from Deck to Aerator Ceramic Disc Cartridge with Temperature Limit Stop 2-Hole Installation Side Spray Assembly With 1.5 GPM Flow Rate	Polished Chrome	12	\$176.00
PARTS	X-1200001	Lever Handle	Polished Chrome	---	\$22.35
	X-1200002	Loop Handle	Polished Chrome	---	\$22.35
	X-2200001	Spout Set	Polished Chrome	---	\$65.00
	X-3900001	Ceramic Disc Cartridge	---	---	\$13.20
	X-4200001	Retainer Cap	Polished Chrome	---	\$7.40
	X-4200002	Retainer Nut	---	---	\$4.60
	X-4200003	Spout Gasket	---	---	\$0.80
	X-4200004	Spout O-Ring	---	---	\$1.30
	X-4200109	Escutcheon	Polished Chrome	---	\$25.40
	X-4200005	Deck Plate	Polished Chrome	---	\$30.45
	X-4200006	Deck Plate Mounting Gasket	---	---	\$2.30
	X-4200007	Diverter Piston	---	---	\$2.30
	X-4200008	Side Spray (For 2LG161, 2LG161H, 2LG171)	---	---	\$67.16
	X-4200009	Side Spray Assembly	Polished Chrome	---	\$42.00
	X-4200010	Deck Plate	Polished Chrome	---	\$29.45
	X-4900001	Hot & Cold Indicator	Polished Chrome	---	\$1.05
	X-4900002	Allen Screw	---	---	\$1.30
	X-4900004	Supply Nut	---	---	\$3.30
	X-5200006	Mounting Kit	---	---	\$2.30
	X-5200015	Mounting Kit	---	---	\$7.40
X-4900081	1.5 GPM Aerator	Polished Chrome	---	\$8.90	

Low flow aerators available upon request.
See page 3 for special order finish options.

Pioneer faucets feature aerators that meet ANSI/ASME A112.18.1 flow requirements of 1.5 GPM

LEGACY // Kitchen Faucets

SINGLE HANDLE KITCHEN FAUCETS



	Model#	Description	Finish	Case	Price
	2LG250	Single Handle Pull-Down Kitchen Faucet Metal Lever Handle	Polished Chrome	6	\$329.00
	2LG250-BN	Pull-Down Head with 2 Spray Patterns Swivel 360° 8-1/2" Reach, 8" from Deck to Aerator Ceramic Disc Cartridge with Temperature Limit Stop 1 or 3 Hole 8" Installation Ball Joint Swivel Sprayhead Easy-Install 30" Flex Supply Lines With 3/8" Connections Quick Connect Spray Head Hose and Weight, Easy-install mounting nut With 1.8 GPM Flow Rate	PVD Brushed Nickel	6	\$354.00
	2LG250-E1.5	With 1.5 GPM Flow Rate	Polished Chrome	6	\$331.00
	2LG250-E1.5-BN		PVD Brushed Nickel	6	\$357.00
	2LG220	Single Handle Pull-Out Kitchen Faucet Metal Lever Handle	Polished Chrome	6	\$227.00
	2LG220-BN	Pull-Out Head with 2 Spray Patterns Swivel 180° 9" Reach, 7" from Deck to Aerator Ceramic Disc Cartridge with Temperature Limit Cap 1 or 3 Hole 8" Installation Ball Joint Swivel Sprayhead Easy-Install 30" Flex Supply Lines With 3/8" Connections With 1.8 GPM Flow Rate Quick Connect Spray Head Hose and Weight, Easy-install mounting nut Deck Cover Plate Included	PVD Brushed Nickel	6	\$248.00
PARTS	X-4200089	Pull-Down Spray Head-2.0 GPM	Polished Chrome	---	\$37.44
	X-4200111	Spray Hose	Polished Chrome	---	\$24.40
	X-4200112	Spout Repair Kit	---	---	\$1.55
	X-3900001	Ceramic Disc Cartridge	---	---	\$13.20
	X-4200002	Retainer Nut	---	---	\$4.60
	X-4200001	Retainer Sleeve	Polished Chrome	---	\$7.40
	X-1200016	Lever Handle	Polished Chrome	---	\$19.05
	X-4200113	Washer	---	---	\$0.80
	X-5200019	Mounting Kit	---	---	\$4.98
	X-4200041	Weight	---	---	\$8.90
	X-4200169	Deck Plate	Polished Chrome	---	\$32.50
	X-4200152	Escutcheon	Polished Chrome	---	\$23.35
	X-5200021	Mounting Tool	---	---	\$7.40
	X-4400024	Allen Screw	---	---	\$1.30
	X-4400073	Hole Cover	Polished Chrome	---	\$3.05

Low flow aerators available upon request.
See page 3 for special order finish options.

Pioneer faucets feature aerators that meet ANSI/ASME A112.18.1 flow requirements of 1.8 GPM

LEGACY // Kitchen Faucets

TWO HANDLE KITCHEN FAUCETS



	Model#	Description	Finish	Case	Price
	2LG110	Two Handle Kitchen Faucet Mini Blade Handles Spout Swivel 360° 9-11/16" Reach, 5-1/4" from Deck to Aerator Ceramic Disc Cartridges 3-Hole 8" Installation With 1.5 GPM Flow Rate	Polished Chrome	12	\$134.00
	2LG240	Two Handle Kitchen Faucet ADA Wrist Blade Handles Hi-Arc Spout Swivel 360° 7-3/16" Reach, 11-3/16" from Deck to Aerator Ceramic Disc Cartridges 3-Hole 8" Installation With 1.5 GPM Flow Rate	Polished Chrome	6	\$140.00
PARTS	X-1900002C	Mini Blade Handle-Cold	Polished Chrome	---	\$10.95
	X-1900002H	Mini Blade Handle-Hot	Polished Chrome	---	\$10.95
	X-1900003C	ADA Wrist Blade Handle-Cold	Polished Chrome	---	\$18.30
	X-1900003H	ADA Wrist Blade Handle-Hot	Polished Chrome	---	\$18.30
	X-2200002	Spout Set	Polished Chrome	---	\$65.00
	X-2200003	High Rise Spout Set	Polished Chrome	---	\$68.00
	X-3900002C	Ceramic Stem-Cold	---	---	\$10.70
	X-3900002H	Ceramic Stem-Hot	---	---	\$10.70
	X-4200006	Base Plate	---	---	\$2.30
	X-4200011	Retainer Nut & Washer	---	---	\$3.30
	X-4200012	Spout O-Ring	---	---	\$1.30
	X-4200013	Spout Gasket	---	---	\$1.57
	X-4200014	Deck Plate	Polished Chrome	---	\$24.40
	X-4200015	Base Plate	---	---	\$3.84
	X-4200017	Spout Sleeve	Polished Chrome	---	\$22.36
	X-4200058	Cap	Polished Chrome	---	\$5.85
	X-4900004	Supply Nut	---	---	\$3.30
	X-4900007	Bonnet Nut	---	---	\$1.80
	X-4900008	Mounting Kit	---	---	\$1.30
	X-4900009C	Mini Blade Handle Index-Cold	---	---	\$1.30
	X-4900009H	Mini Blade Handle Index-Hot	---	---	\$1.30
	X-4900010	ADA Wrist Blade Handle Screw	---	---	\$1.30
	X-4900011C	Index-Cold	---	---	\$0.80
	X-4900011H	Index-Hot	---	---	\$0.80
	X-4900012	Spout O-Ring	---	---	\$1.30
	X-4900013	Spout Snap Ring	---	---	\$1.30
	X-4900066	Mini Blade Handle Screw	---	---	\$1.30
	X-4900081	1.5 GPM Aerator	Polished Chrome	---	\$8.90
	X-4900082	1.0 GPM Aerator	Polished Chrome	---	\$9.40
	X-4900083	0.5 GPM Aerator	Polished Chrome	---	\$13.20

Builder Tract Packs sold in case quantities only.
Low flow aerators available upon request.
See page 3 for special order finish options.

Pioneer faucets feature aerators that meet ANSI/ASME A112.18.1 flow requirements of 1.5 GPM

LEGACY // Bar Faucets

TWO HANDLE BAR FAUCETS















	Model#	Description	Finish	Case	Price
	5LG120	Two Handle Bar Faucet ADA Wrist Blade Handles Gooseneck Spout Swivel 360° 5-3/16" Reach, 5-7/8" from Deck to Aerator Ceramic Disc Cartridges 2 or 3-Hole 4" Installation With 1.5 GPM Flow Rate	Polished Chrome	12	\$104.00
	5LG220	Two Handle Bar Faucet ADA Wrist Blade Handles Gooseneck Spout Swivel 360° 3-5/8" Reach, 7" from Deck to Aerator Ceramic Disc Cartridges 2 or 3-Hole 4" Installation With 1.5 GPM Flow Rate	Polished Chrome	12	\$106.00
PARTS	X-1900003C	ADA Wrist Blade Handle-Cold	Polished Chrome	---	\$18.30
	X-1900003C	ADA Wrist Blade Handle-Cold	Polished Chrome	---	\$18.30
	X-1900003H	ADA Wrist Blade Handle-Hot	Polished Chrome	---	\$18.30
	X-49000037	Bonnet Nut	---	---	\$1.95
	X-4900116	Gasket	---	---	\$0.70
	X-3900002C	Ceramic Stem - Cold	---	---	\$10.70
	X-3900002H	Ceramic Stem - Hot	---	---	\$10.70
	X-4500002	Deck Plate	Polished Chrome	---	\$14.50
	X-4500003	Base Plate	---	---	\$1.80
	X-4900008	Mounting Kit	---	---	\$1.30
	X-4900004	Supply Nut	---	---	\$3.30
	X-2500001	5-3/16" Reach Gooseneck Spout	Polished Chrome	---	\$45.00
	X-2500002	3-5/8" Reach Gooseneck Spout	Polished Chrome	---	\$52.00
	X-4900010	ADA Wrist Blade Handle Screw	---	---	\$1.30
	X-4900011C	ADA Wrist Blade Handle Index-Cold	---	---	\$0.80
	X-4900011H	ADA Wrist Blade Handle Index-Hot	---	---	\$0.80
	X-4500001	Spout Sleeve	Polished Chrome	---	\$11.95
	X-4900013	Spout Snap Ring	---	---	\$1.30
	X-4900012	Spout O-ring	---	---	\$1.30
	X-4900084	1.5 GPM Aerator	Polished Chrome	---	\$9.40
X-4900085	1.0 GPM Aerator	Polished Chrome	---	\$10.15	
X-4900086	0.5 GPM Aerator	Polished Chrome	---	\$14.00	

Low flow aerators available upon request.
See page 3 for special order finish options.

Pioneer faucets feature aerators that meet ANSI/ASME A112.18.1 flow requirements of 1.5 GPM

LEGACY // Lavatory Faucets

SINGLE HANDLE LAVATORY FAUCETS

		Model#	Description	Finish	Case	Price
	   	3LG160	Single Handle Lavatory Faucet Metal Lever Handle	Polished Chrome	12	\$136.00
		3LG160-BN	4-5/8" Reach, 1-7/8" from Deck to Aerator Ceramic Disc Cartridge with Temperature Limit Stop 3-Hole 4" Installation Brass Pop-Up Drain Assembly With 1.2 GPM Flow Rate	PVD Brushed Nickel	12	\$148.00
		3LG160-E0.5	With 0.5 GPM Flow Rate	Polished Chrome	12	\$139.00
		3LG160-E0.5-BN		PVD Brushed Nickel	12	\$151.00
		3LG160B	Builder Tract Pack	Polished Chrome	12	\$134.00
		3LG160B-BN		PVD Brushed Nickel	12	\$146.00
		3LG160B-E0.5		Polished Chrome	12	\$137.00
		3LG160H	18" SS Flex Connectors with 3/8" Compression Connection Nuts	Polished Chrome	12	\$138.00
		3LG160H-BN		PVD Brushed Nickel	12	\$150.00
		3LG160H-E0.5	With 0.5 GPM Flow Rate	Polished Chrome	12	\$141.00
		3LG160H-E0.5-BN		PVD Brushed Nickel	12	\$151.00
	   	3LG161	Single Handle Lavatory Faucet Metal Lever Handle 4-5/8" Reach, 1-7/8" from Deck to Aerator Ceramic Disc Cartridge with Temperature Limit Stop 3-Hole 4" Installation With 1.2 GPM Flow Rate	Polished Chrome	12	\$109.00
	   	3LG161G	Single Handle Lavatory Faucet Metal Lever Handle 4-5/8" Reach, 1-7/8" from Deck to Aerator Ceramic Disc Cartridge with Temperature Limit Stop 3-Hole 4" Installation Brass Grid Strainer Drain Assembly With 1.2 GPM Flow Rate	Polished Chrome	12	\$130.00

Builder Tract Packs sold in case quantities only.
Low flow aerators available upon request.
See page 3 for special order finish options.

Pioneer faucets feature aerators that meet ANSI/ASME A112.18.1 flow requirements of 1.5 GPM

LEGACY // Lavatory Faucets

SINGLE HANDLE LAVATORY FAUCETS

























	Model#	Description	Finish	Case	Price
PARTS	X-1300001	Lever Handle	Polished Chrome	---	\$22.35
	X-1300002	Loop Handle	Polished Chrome	---	\$22.35
	X-1300003	Acrylic Ball Handle	---	---	\$7.65
	X-4900017	Retainer Cap	Polished Chrome	---	\$11.95
	X-4900018	Retainer Nut	---	---	\$4.10
	X-3900003	Ceramic Disc Cartridge	---	---	\$12.95
	X-4300003	Base Plate	---	---	\$1.80
	X-5300001	Mounting Kit	---	---	\$2.80
	X-4900004	Supply Nut	---	---	\$3.30
	X-6300001	Brass Pop-Up	Polished Chrome	---	\$40.00
	X-6300002	Brass Grid Strainer	Polished Chrome	---	\$51.00
	X-4900001	Hot & Cold Indicator	---	---	\$1.05
	X-4900002	Allen Screw	---	---	\$1.30
	X-4300004	Index Button	---	---	\$2.30
	X-4300005	Screw	---	---	\$0.80
	X-4900081	1.5 GPM Aerator	Polished Chrome	---	\$8.90
	X-4900082	1.0 GPM Aerator	Polished Chrome	---	\$9.40
	X-4900083	0.5 GPM Aerator	Polished Chrome	---	\$13.20

Low flow aerators available upon request.

Pioneer faucets feature aerators that meet ANSI/ASME A112.18.1 flow requirements of 1.5 GPM

LEGACY // Lavatory Faucets

SINGLE HANDLE LAVATORY FAUCETS

		Model#	Description	Finish	Case	Price
	   	3LG260H	Single Handle Lavatory Faucet Metal Lever Handle	Polished Chrome	12	\$159.00
		3LG260H-BN	4-3/8" Reach, 2-3/8" from Deck to Aerator Ceramic Disc Cartridge with Temperature Limit Stop 1-Hole Installation Brass Pop-Up Drain Assembly Easy-Install 18" Flex Supply Lines With 3/8" Connections With 1.2 GPM Flow Rate	PVD Brushed Nickel	12	\$170.00
		3LG260H-E0.5	With 0.5 GPM Flow Rate	Polished Chrome	12	\$162.00
		3LG260H-E0.5-BN		PVD Brushed Nickel	12	\$173.00
		3LG260BH	Builder Tract Pack	Polished Chrome	12	\$157.00
		3LG260BH-BN		PVD Brushed Nickel	12	\$168.00
	   	3LG260H-WD	1 or 3-Hole 4" Installation Deck Cover Plate Included	Polished Chrome	12	\$166.00
		3LG260H-WD-BN		PVD Brushed Nickel	12	\$182.60
		3LG262BH	50/50 Pop-up Drain Assembly Builder Tract Pack	Polished Chrome	12	\$143.00
	   	3LG264H	Single Handle Lavatory Faucet Metal Lever Handle	Polished Chrome	12	\$130.00
		3LG264H-BN	4-3/8" Reach, 2-3/8" from Deck to Aerator Ceramic Disc Cartridge with Temperature Limit Stop 1-Hole Installation Easy-Install 18" Flex Supply Lines With 3/8" Connections With 1.2 GPM Flow Rate	PVD Brushed Nickel	12	\$143.00
	   	3LG264H-WD	1 or 3-Hole 4" Installation Deck Cover Plate Included	Polished Chrome	12	\$140.00
		3LG264H-WD-BN		PVD Brushed Nickel	12	\$154.00
	   	3LG264GH	Single Handle Lavatory Faucet Metal Lever Handle 4-3/8" Reach, 2-3/8" from Deck to Aerator Ceramic Disc Cartridge with Temperature Limit Stop 1-Hole Installation Brass Grid Strainer Drain Assembly Easy-Install 18" Flex Supply Lines With 3/8" Connections With 1.2 GPM Flow Rate	Polished Chrome	12	\$153.00
		3LG264GH-WD	1 or 3-Hole 4" Installation Deck Cover Plate Included	Polished Chrome	12	\$163.00

Builder Tract Packs sold in case quantities only.
Low flow aerators available upon request.
See page 3 for special order finish options.

Pioneer faucets feature aerators that meet ANSI/ASME A112.18.1 flow requirements of 1.5 GPM

LEGACY

LEGACY // Lavatory Faucets

SINGLE HANDLE LAVATORY FAUCETS











	Model#	Description	Finish	Case	Price
PARTS	X-1300001	Lever Handle	Polished Chrome	---	\$22.35
	X-1300002	Loop Handle	Polished Chrome	---	\$22.35
	X-4900017	Retainer Cap	Polished Chrome	---	\$11.95
	X-4900018	Retainer Nut	---	---	\$4.10
	X-3900003	Ceramic Disc Cartridge	---	---	\$12.95
	X-4300024	Hole Cover	Polished Chrome	---	\$1.30
	X-5300007	Mounting Kit	---	---	\$6.60
	X-6300001	Brass Pop-Up	Polished Chrome	---	\$40.00
	X-6300002	Brass Grid Strainer	Polished Chrome	---	\$51.00
	X-4300038	Deck Cover Plate	Polished Chrome	---	\$16.75
	X-4900001	Hot & Cold Indicator	---	---	\$1.05
	X-4900002	Allen Screw	---	---	\$1.30
	X-4900081	1.5 GPM Aerator	Polished Chrome	---	\$8.90
	X-4900082	1.0 GPM Aerator	Polished Chrome	---	\$9.40
	X-4900083	0.5 GPM Aerator	Polished Chrome	---	\$13.20

Low flow aerators available upon request.

Pioneer faucets feature aerators that meet ANSI/ASME A112.18.1 flow requirements of 1.5 GPM

LEGACY // Lavatory Faucets

TWO HANDLE LAVATORY FAUCETS

	Model#	Description	Finish	Case	Price
	 3LG110	Two Handle Lavatory Faucet Mini Blade Handles 3-9/16" Reach, 1-15/16" from Deck to Aerator Ceramic Disc Cartridges 3-Hole 4" Installation Brass Pop-Up Drain Assembly With 1.2 GPM Flow Rate	Polished Chrome	12	\$116.00
	 3LG111	Two Handle Lavatory Faucet Mini Blade Handles 3-9/16" Reach, 1-15/16" from Deck to Aerator Ceramic Disc Cartridges 3-Hole 4" Installation With 1.2 GPM Flow Rate	Polished Chrome	12	\$88.00
	 3LG121	Two Handle Lavatory Faucet ADA Wrist Blade Handles 3-9/16" Reach, 1-15/16" from Deck to Aerator Ceramic Disc Cartridges 3-Hole 4" Installation With 1.2 GPM Flow Rate	Polished Chrome	12	\$96.00
	 3LG121G	Two Handle Lavatory Faucet ADA Wrist Blade Handles 3-9/16" Reach, 1-15/16" from Deck to Aerator Ceramic Disc Cartridges 3-Hole 4" Installation Brass Grid Strainer Drain Assembly With 1.2 GPM Flow Rate	Polished Chrome	12	\$119.00
	 3LG130	Two Handle Lavatory Faucet Metal Lever Handles 3-9/16" Reach, 1-15/16" from Deck to Aerator Ceramic Disc Cartridges 3-Hole 4" Installation Brass Pop-Up Drain Assembly With 1.2 GPM Flow Rate	Polished Chrome	12	\$123.00
	 3LG130-BN		PVD Brushed Nickel	12	\$127.00

Builder Tract Packs sold in case quantities only.
Low flow aerators available upon request.
See page 3 for special order finish options.

Pioneer faucets feature aerators that meet ANSI/ASME A112.18.1 flow requirements of 1.5 GPM

LEGACY

LEGACY // Lavatory Faucets

TWO HANDLE LAVATORY FAUCETS









	Model#	Description	Finish	Case	Price
PARTS	X-190001C	Acrylic Handle-Cold	---	---	\$5.35
	X-190001H	Acrylic Handle-Hot	---	---	\$5.35
	X-190002C	Mini Blade Handle-Cold	Polished Chrome	---	\$10.95
	X-190002H	Mini Blade Handle-Hot	Polished Chrome	---	\$10.95
	X-190003C	Wrist Blade Handle-Cold	Polished Chrome	---	\$18.30
	X-190003H	Wrist Blade Handle-Hot	Polished Chrome	---	\$18.30
	X-190004C	Lever Handle-Cold	Polished Chrome	---	\$19.55
	X-190004H	Lever Handle-Hot	Polished Chrome	---	\$19.55
	X-490007	Bonnet Nut	---	---	\$1.80
	X-390002C	Ceramic Stem-Cold	---	---	\$10.70
	X-390002H	Ceramic Stem-Hot	---	---	\$10.70
	X-490008	Mounting Kit	---	---	\$1.30
	X-490004	Supply Nut	---	---	\$3.30
	X-630001	Brass Pop-Up	Polished Chrome	---	\$40.00
	X-630002	Brass Grid Strainer	Polished Chrome	---	\$51.00
	X-490005C	Acrylic Handle Index-Cold	---	---	\$1.30
	X-490005H	Acrylic Handle Index-Hot	---	---	\$1.30
	X-490006	Handle Screw	---	---	\$1.30
	X-490009C	Mini Blade Handle Index-Cold	---	---	\$1.30
	X-490009H	Mini Blade Handle Index-Hot	---	---	\$1.30
	X-4900066	Mini Blade Handle Screw	---	---	\$1.30
	X-4900010	ADA Wrist Blade Handle Screw	---	---	\$1.30
	X-4900011C	ADA Wrist Blade Handle Index-Cold	---	---	\$0.80
	X-4900011H	ADA Wrist Blade Handle Index-Hot	---	---	\$0.80
	X-4900014C	Lever Handle Index-Cold, Hot	Polished Chrome	---	\$2.30
	X-4900014H	Lever Handle Index-Cold, Hot	Polished Chrome	---	\$2.30
	X-4900015	Lever Handle Screw	---	---	\$1.30
	X-4300058	1.5 GPM Aerator	Polished Chrome	---	\$8.90
	X-4300059	1.0 GPM Aerator	Polished Chrome	---	\$9.40
	X-4300047	0.5 GPM Aerator	Polished Chrome	---	\$13.45

Builder Tract Packs sold in case quantities only.
Low flow aerators available upon request.

Pioneer faucets feature aerators that meet ANSI/ASME A112.18.1 flow requirements of 1.5 GPM

LEGACY // Tub & Shower

TUB & SHOWER TRIM SETS

	Model#	Description	Finish	Case	Price
	  4LG100T	Single Handle Tub and Shower Trim Set Metal Lever Handle	Polished Chrome	12	\$173.00
	4LG100T-BN	Ceramic Disc Cartridge with Temperature Limit Stop	PVD Brushed Nickel	12	\$193.00
	4LG100T-MZ	Four Function 3-3/8" Diameter Showerhead Shower Arm and Flange Combo 1/2" IPS/Slip-On Diverter Tub Spout Color Match Sleeve and Retaining Ring With 1.75 GPM Flow Rate For Use with 4020B Valve - Valve not included	Moroccan Bronze	12	\$205.00
	  4LG300T	Single Handle Shower Trim Set Metal Lever Handle Ceramic Disc Cartridge with Temperature Limit Cap Four Function 3-3/8" Diameter Showerhead Shower Arm and Flange Color Match Sleeve and Retaining Ring With 1.75 GPM Flow Rate For Use with 4020B Valve - Valve not included	Polished Chrome	12	\$155.00
	 4LG400T	Single Handle Valve Trim Set Metal Lever Handle	Polished Chrome	12	\$114.00
	4LG400T-BN	Ceramic Disc Cartridge with Temperature Limit Cap Color Match Sleeve and Retaining Ring For Use with 4020B Valve - Valve not included	PVD Brushed Nickel	12	\$131.00





See page 3 for special order finish options.

Pioneer showerheads meet ANSI/ASME A112.18.1 flow requirements of maximum 1.75 GPM

LEGACY

LEGACY // Tub & Shower

TUB & SHOWER TRIM SETS





	Model#	Description	Finish	Case	Price
	 4LG100T-ADA	Single Handle Tub and Shower Trim Set with Diverter and Handheld Showerhead Four Function 3-3/8" Diameter Showerhead-1.75 GPM Shower Arm and Flange Metal Lever Handles Color Match Sleeve and Retaining Ring Ceramic Disc Cartridge with Temperature Limit Cap Three Way Diverter Valve Trim For Use with 4020B and 4100B Valves - Valves not included Combo 1/2" IPS/Slip-On Diverter Tub Spout w/ Escutcheon Five Functions Handheld Showerhead w/ Non-Positive Shut Off-1.5 GPM 24" Slide Bar with Brass Mounts 60" Stainless Steel Flex Hose Brass Drop Ell with Vacuum Breaker	Polished Chrome	---	\$416.50
	4LG300T-ADA	Less Tub Spout	Polished Chrome	---	\$381.70
	 4LG400T-ADA	Single Handle Valve Trim Set with Handheld Showerhead Metal Lever Handle Color Match Sleeve and Retaining Ring Ceramic Disc Cartridge with Temperature Limit Cap For Use with 4020B Valve - Valve not included Five Functions Handheld Showerhead W/Non-Positive Shut Off-1.5 GPM 24" Slide Bar with Brass Mounts 60" Stainless Steel Flex Hose Brass Drop Ell with Vacuum Breaker	Polished Chrome	---	\$343.00
PARTS	X-1400025	Lever Handle	Polished Chrome	---	\$19.30
	X-3400007	Ceramic Cartridge W/ Temperature Limit Stop	---	---	\$49.00
	X-4200001	Retainer Cap	Polished Chrome	---	\$7.40
	X-4400030	Sleeve	Polished Chrome	---	\$23.35
	X-4400062	Face Plate Screws	Polished Chrome	---	\$4.85
	X-4400080	Lock Nut	---	---	\$4.35
	X-4600025	Rubber Gasket	---	---	\$2.30
	X-4600035	Sleeve	Polished Chrome	---	\$26.40
	X-4600036	Adapter	---	---	\$1.30
	X-4900024	Allen Wrench	---	---	\$1.30
	X-4900080	Allen Screw	---	---	\$1.30
	X-6400079	1.75 GPM Showerhead Four Function Showerhead	Polished Chrome	---	\$35.00
	X-6400002	Shower Arm	Polished Chrome	---	\$13.20
	X-6400003	Legacy Shower Arm Flange	Polished Chrome	---	\$10.95
	X-6400058	Legacy Face Plate	Polished Chrome	---	\$45.00

See page 3 for special order finish options.

Pioneer showerheads meet ANSI/ASME A112.18.1 flow requirements of maximum 1.75 GPM

PREMIUM // Kitchen Faucets

TWO HANDLE WALL MOUNT FAUCETS

	Model#	Description	Finish	Case	Price
	 2PM440	Two Handle Wall Mount Faucet Metal Cross Handles Hi-Tubular Spout 9-1/4" Reach Ceramic Disc Cartridges 2-Hole 3-1/2" to 8-1/2" Installation 1/2" Eccentric Connections With 1.5 GPM Flow Rate	Polished Chrome	12	\$170.00
	 2PM540	Two Handle Wall Mount Faucet Metal Cross Handles Tubular Spout 10-1/2" Reach Ceramic Disc Cartridges 2-Hole 3-1/2" to 8-1/2" Installation 1/2" Eccentric Connections With 1.5 GPM Flow Rate	Polished Chrome	12	\$170.00
PARTS	X-120005C	Cross Handle-Cold	Polished Chrome	---	\$15.00
	X-120005H	Cross Handle-Hot	Polished Chrome	---	\$15.00
	X-4200054	Handle Bonnet Nut	Polished Chrome	---	\$8.15
	X-3200003	Ceramic Stem	---	---	\$14.00
	X-4200056	Eccentric Elbow	Polished Chrome	---	\$27.45
	X-4200057	Flange	Polished Chrome	---	\$9.15
	X-2200008	High Spout	Polished Chrome	---	\$45.00
	X-2200009	Tubular Spout	Polished Chrome	---	\$44.00
	X-4200055C	Index Button-Cold	---	---	\$3.30
	X-4200055H	Index Button-Hot	---	---	\$3.30
	X-4900029	Cross Handle Screw	---	---	\$1.30
	X-4900030	Eccentric Elbow Washer	---	---	\$1.80
	X-4200053	Spout Bonnet Nut	Polished Chrome	---	\$5.60
	X-4200090	Spout Snap Ring	---	---	\$1.30
	X-4900012	Tubular Spout O-Ring	---	---	\$1.30
	X-4900084	1.5 GPM Aerator	Polished Chrome	---	\$9.40
	X-4900085	1.0 GPM Aerator	Polished Chrome	---	\$10.15
X-4900086	0.5 GPM Aerator	Polished Chrome	---	\$14.00	



Low flow aerators available upon request.
See page 3 for special order finish options.

Pioneer faucets feature aerators that meet ANSI/ASME A112.18.1 flow requirements of 1.5 GPM

PREMIUM

PREMIUM // Bar Faucets

SINGLE HANDLE BAR FAUCETS







	Model#	Description	Finish	Case	Price
	  5PM330	Single Handle Bar Faucet Metal Lever Handle Rigid Gooseneck Spout 5-1/4" Reach, 5-1/4" from Deck to Aerator Stainless Steel Ball Operation 2-Hole 4" to 12" Installation SS Flex Connectors With 1.5 GPM Flow Rate	Polished Chrome	6	\$193.00
PARTS	X-1200004	Lever Handle	Polished Chrome	---	\$16.75
	X-2500003	Gooseneck Rigid Spout	Polished Chrome	---	\$99.00
	X-3200002	SS Ball	---	---	\$3.30
	X-4200032	Spout Washer	---	---	\$4.35
	X-4200044	Hose	---	---	\$9.15
	X-4200045	Retainer Cap & Adjusting Ring	Polished Chrome	---	\$6.35
	X-4200046	Cam & Washer	---	---	\$2.30
	X-4200048	Base & Gasket	Polished Chrome	---	\$13.45
	X-4200050	Handle Hole Cover	---	---	\$1.30
	X-4200051	Handle Allen Screw	---	---	\$1.30
	X-4900004	Supply Nut	---	---	\$3.30
	X-4900019	Springs & Seats	---	---	\$1.30
	X-5200003	Spout Mounting Kit	---	---	\$3.30
	X-5200008	Mounting Tool	---	---	\$5.35
	X-5200009	Valve Mounting Kit	---	---	\$2.80
	X-4900084	1.5 GPM Aerator	Polished Chrome	---	\$9.40

See page 3 for special order finish options.

Pioneer faucets feature aerators that meet ANSI/ASME A112.18.1 flow requirements of 1.5 GPM

DEL MAR // Kitchen Faucets

TWO HANDLE KITCHEN FAUCETS

		Model#	Description	Finish	Case	Price
		2DM201	Two Handle Kitchen Widespread Faucet Metal Lever Handles	Polished Chrome	6	\$314.00
		2DM201-BN	Gooseneck Spout Swivel 360° 8-1/16" Reach, 6-11/16" from Deck to Aerator	PVD Brushed Nickel	6	\$340.00
		2DM201-ORB	Ceramic Disc Cartridges 3 or 4-Hole 6" to 16" Installation Side Spray Assembly With 1.5 GPM Flow Rate	Oil Rubbed Bronze	6	\$354.00
		2DM300	Two Handle Kitchen Faucet Metal Lever Handles Gooseneck Spout Swivel 360° 8-1/16" Reach, 7-1/8" from Deck to Aerator Ceramic Disc Cartridges 3-Hole 8" Installation With 1.5 GPM Flow Rate	Polished Chrome	6	\$170.00
		2DM301	Two Handle Kitchen Faucet Metal Lever Handles	Polished Chrome	6	\$203.00
		2DM301-BN	Gooseneck Spout Swivel 360° 8-1/16" Reach, 7-1/8" from Deck to Aerator Ceramic Disc Cartridges 4-Hole 8" Installation Side Spray Assembly With 1.5 GPM Flow Rate	PVD Brushed Nickel	6	\$219.00

Low flow aerators available upon request.
See page 3 for special order finish options.

Pioneer faucets feature aerators that meet ANSI/ASME A112.18.1 flow requirements of 1.5 GPM

DEL MAR

DEL MAR // Kitchen Faucets

TWO HANDLE KITCHEN FAUCETS

	Model#	Description	Finish	Case	Price
PARTS	X-1200006	Lever Handle	Polished Chrome	---	\$22.35
	X-2200004	High Gooseneck Spout Set	Polished Chrome	---	\$102.00
	X-2200005	High Gooseneck Spout Set	Polished Chrome	---	\$147.00
	X-3900002C	Ceramic Stem - Cold	---	---	\$10.70
	X-3900002H	Ceramic Stem - Hot	---	---	\$10.70
	X-4200016	Diverter Piston	---	---	\$8.09
	X-4200018	Side Spray Assembly	Polished Chrome	---	\$31.50
	X-4200020	Gooseneck Spout Sleeve	Polished Chrome	---	\$39.00
	X-4200021	Gooseneck Spout Deck Plate	Polished Chrome	---	\$28.45
	X-4200022	Gooseneck Spout Deck Plate Mounting Gasket	---	---	\$2.30
	X-4200023	Gooseneck Spout Escutcheon	Polished Chrome	---	\$17.55
	X-4200025	Cross Connector	---	---	\$35.00
	X-4200049	Cap And Washer	---	---	\$2.30
	X-4900002	3/32" Allen Screw	---	---	\$1.30
	X-4900004	Supply Nut	---	---	\$3.30
	X-4900007	Bonnet Nut	---	---	\$1.80
	X-4900008	Mounting Kit	---	---	\$1.30
	X-4900012	Tubular Spout O-Ring	---	---	\$1.30
	X-4900013	Tubular Spout Snap Ring	---	---	\$1.30
	X-4900022	Bonnet Nut	---	---	\$4.35
	X-4900023	Handle Escutcheon	Polished Chrome	---	\$18.30
	X-4900024	3/32" Allen Wrench	---	---	\$1.30
	X-5200003	Spout Mounting Kit	---	---	\$3.30
	X-5900001	Valve Mounting Kit	---	---	\$7.15
	X-4200114	Female 55/64" Thread Aerator-1.5 GPM	Polished Chrome	---	\$10.70

Pioneer faucets feature aerators that meet ANSI/ASME A112.18.1 flow requirements of 1.5 GPM

DEL MAR // Bar Faucets

TWO HANDLE BAR FAUCETS

	Model#	Description	Finish	Case	Price
	5DM100	Two Handle Bar Faucet Metal Lever Handles	Polished Chrome	12	\$119.00
	5DM100-BN	Gooseneck Spout Swivel 360° 5-3/16" Reach, 5-7/8" from Deck to Aerator	PVD Brushed Nickel	12	\$131.00
	5DM100-ORB	Ceramic Disc Cartridges 2 or 3-Hole 4" Installation With 1.5 GPM Flow Rate	Oil Rubbed Bronze	12	\$136.00
PARTS	X-1900005	Lever Handle	Polished Chrome	---	\$22.35
	X-4900007	Bonnet Nut	---	---	\$1.80
	X-3900002C	Ceramic Stem - Cold	---	---	\$10.70
	X-3900002H	Ceramic Stem - Hot	---	---	\$10.70
	X-4500002	Deck Plate	Polished Chrome	---	\$14.50
	X-4500003	Deck Plate Mounting Gasket	---	---	\$1.80
	X-4900008	Mounting Kit	---	---	\$1.30
	X-4900004	Supply Nut	---	---	\$3.30
	X-2500001	5-3/16" Reach Gooseneck Spout	Polished Chrome	---	\$45.00
	X-4900002	Allen Screw	---	---	\$1.30
	X-4500001	Spout Sleeve Set	Polished Chrome	---	\$11.95
	X-4900013	Tubular Spout Snap Ring	---	---	\$1.30
	X-4900012	Tubular Spout O-ring	---	---	\$1.30
	X-4900084	1.5 GPM Aerator	Polished Chrome	---	\$9.40

See page 3 for special order finish options.

Pioneer faucets feature aerators that meet ANSI/ASME A112.18.1 flow requirements of 1.5 GPM

DEL MAR

DEL MAR // Lavatory Faucets

TWO HANDLE LAVATORY FAUCETS



	Model#	Description	Finish	Case	Price
	3DM100	Two Handle Lavatory Faucet Metal Lever Handles	Polished Chrome	6	\$177.00
	3DM100-BN	6-1/16" Reach, 2-1/8" from Deck to Aerator Ceramic Disc Cartridges 3-Hole 4" Installation Brass Pop-Up Drain Assembly With 1.2 GPM Flow Rate	PVD Brushed Nickel	6	\$191.70
PARTS	X-1900005	Lever Handle	Polished Chrome	---	\$22.35
	X-4900037	Bonnet Nut	---	---	\$1.95
	X-3900002C	Ceramic Stem - Cold	---	---	\$10.70
	X-3900002H	Ceramic Stem - Hot	---	---	\$10.70
	X-4300006	Base Plate	---	---	\$2.30
	X-4900008	Mounting Kit	---	---	\$1.30
	X-4900004	Supply Nut	---	---	\$3.30
	X-6300003	Brass Pop-Up Drain Assembly	Polished Chrome	---	\$36.00
	X-4900002	3/32" Allen Screw	---	---	\$1.30
	X-4300008	Pop-Up Lift Rod	Polished Chrome	---	\$12.95
	X-4300061	1.0 GPM Aerator	Polished Chrome	---	\$14.00
	X-4300062	0.5 GPM Aerator	Polished Chrome	---	\$18.55

Low flow aerators available upon request.
See page 3 for special order finish options.

Pioneer faucets feature aerators that meet ANSI/ASME A112.18.1 flow requirements of 1.5 GPM

DEL MAR // Lavatory Faucets

TWO HANDLE LAVATORY FAUCETS

	Model#	Description	Finish	Case	Price
	3DM200	Two Handle Lavatory Widespread Faucet Metal Lever Handles	Polished Chrome	6	\$301.00
	3DM200-BN	Rigid C Style Spout 5-7/8" Reach, 2-1/8" from Deck to Aerator Ceramic Disc Cartridges 3-Hole 6" to 16" Installation Brass Pop-Up Drain Assembly With 1.2 GPM Flow Rate	PVD Brushed Nickel	6	\$322.00
	3DM200-E0.5	With 0.5 GPM Flow Rate	Polished Chrome	6	\$303.00
	3DM300	Two Handle Lavatory Widespread Faucet Metal Lever Handles	Polished Chrome	6	\$294.00
	3DM300-ORB	Rigid J Style Spout 4-5/8" Reach, 4" from Deck to Aerator Ceramic Disc Cartridges 3-Hole 6" to 16" Installation Brass Pop-Up Drain Assembly With 1.2 GPM Flow Rate	Oil Rubbed Bronze	6	\$339.00
PARTS	X-1200006*	Lever Handle	Polished Chrome	---	\$22.35
	X-2300001*	'C' Spout	Polished Chrome	---	\$154.00
	X-2300002*	'J' Spout	Polished Chrome	---	\$142.00
	X-3900002C	Ceramic Stem - Cold	---	---	\$10.70
	X-3900002H	Ceramic Stem - Hot	---	---	\$10.70
	X-4300010*	C Spout Escutcheon	Polished Chrome	---	\$17.55
	X-4300011	'Y' Connector	---	---	\$16.00
	X-4300041	Pop-Up Lift Rod	Polished Chrome	---	\$14.50
	X-4900002	3/32" Allen Screw	---	---	\$1.30
	X-4900004	Supply Nut	---	---	\$3.30
	X-4900020	'Y' Connector & Washer	---	---	\$21.35
	X-4900022	Bonnet Nut	---	---	\$4.35
	X-4900023	Handle Escutcheon	Polished Chrome	---	\$18.30
	X-4900024	3/32" Allen Wrench	---	---	\$1.30
	X-5300003	J Spout Mounting Kit	---	---	\$2.80
	X-5900001	Valve Mounting Kit	---	---	\$7.15
	X-6300012*	Brass Pop-Up Drain Assembly	Polished Chrome	---	\$41.00
	X-4300063	1.5 GPM Aerator	Polished Chrome	---	\$12.45
	X-4300064	1.0 GPM Aerator	Polished Chrome	---	\$14.50
	X-4300065	0.5 GPM Aerator	Polished Chrome	---	\$20.60
	X-4900081	1.5 GPM Aerator	Polished Chrome	---	\$8.90
	X-4900082*	1.0 GPM Aerator	Polished Chrome	---	\$9.40
	X-4900083	0.5 GPM Aerator	Polished Chrome	---	\$13.20



Low flow aerators available upon request.
See page 3 for special order finish options.

Pioneer aerators meet ANSI/ASME A112.18.1 flow requirements of maximum 1.5 GPM

DEL MAR

DEL MAR // Tub & Shower

TUB & SHOWER TRIM SETS

	Model#	Description	Finish	Case	Price
	4DM100T	Single Handle Tub and Shower Trim Set Metal Lever Handle	Polished Chrome	12	\$200.00
	4DM100T-BN	Ceramic Disc Cartridge with Temperature Limit Stop Single Function 3-3/8" Standard Showerhead Shower Arm and Flange Combo 1/2" IPS/Slip-On Diverter Tub Spout Tub Spout Escutcheon Color Match Sleeve and Retaining Ring With 1.75 GPM Flow Rate For Use with 4020B Valve - Valve not included	PVD Brushed Nickel	12	\$222.00
	4DM300T	Single Handle Shower Trim Set Metal Lever Handle	Polished Chrome	12	\$180.00
	4DM300T-BN	Ceramic Disc Cartridge with Temperature Limit Stop Single Function 3-3/8" Standard Showerhead Shower Arm and Flange Color Match Sleeve and Retaining Ring With 1.75 GPM Flow Rate For Use with 4020B Valve - Valve not included	PVD Brushed Nickel	12	\$200.00
	4DM300T-ORB		Oil Rubbed Bronze	12	\$213.00

Low flow showerheads available upon request.
See page 3 for special order finish options.

Pioneer showerheads meet ANSI/ASME A112.18.1 flow requirements of maximum 1.75 GPM



DEL MAR // Tub & Shower

TUB & SHOWER TRIM SETS

	Model#	Description	Finish	Case	Price
PARTS	X-6400015	Shower Arm Flange	Polished Chrome	---	\$4.85
	X-6400002	Shower Arm	---	---	\$13.20
	X-6400019	Single Function Standard Showerhead	Polished Chrome	---	\$30.45
	X-3400007	Ceramic Disc Cartridge	Polished Chrome	---	\$49.00
	X-4400030*	Sleeve	Polished Chrome	---	\$23.35
	X-4400080	Lock Nut	---	---	\$4.35
	X-4200001	Retainer Cap	---	---	\$7.40
	X-6400059	Face plate	---	---	\$40.00
	X-1400026	Lever Handle	Polished Chrome	---	\$30.45
	X-4900024	3/32" Allen Wrench	Polished Chrome	---	\$1.30
	X-4400002	Spout Escutcheon	Polished Chrome	---	\$10.95
	X-6400021	Combo 1/2" IPS/Slip-On Diverter Tub Spout	Polished Chrome	---	\$39.00
	X-4900080	Allen Screw	---	---	\$1.30
	X-4400062*	Face Plate Screws	Polished Chrome	---	\$4.85

DEL MAR // Tub & Shower

HANDHELD SHOWER SETS

		Model#	Description	Finish	Case	Price
		6DM400	Handheld Shower Set	Polished Chrome	6	\$245.00
		6DM400-BN	25-1/8" Slide Bar with Brass Mount Five Function Handheld Showerhead	PVD Brushed Nickel	6	\$265.00
		6DM400-ORB	Brass Drop Ell With Vacuum Breaker 60" Stainless Steel Flex Hose With 1.75 GPM Flow Rate	Oil Rubbed Bronze	6	\$276.00
PARTS		X-4600048	1.75 GPM Five Function Handheld Shower	Polished Chrome	---	\$106.03
		X-4600006	60" Stainless Steel Flex Hose	Polished Chrome	---	\$120.00
		X-4600005	Vacuum Breaker	Polished Chrome	---	\$14.50
		X-4600004	Drop Ell	Polished Chrome	---	\$45.00
		X-5600001	Mounting Kit	---	---	\$1.30
		X-4600001	Handheld Shower Slide Bar Brass Mount	Polished Chrome	---	\$31.50
		X-4600003	Slide Bar	Polished Chrome	---	\$99.00
		X-4900024	3/32" Allen Wrench	---	---	\$1.30
		X-4600002	Mounting Screw	---	---	\$1.30
		X-4900002	3/32" Allen Screw	---	---	\$1.30

Low flow showerheads available upon request.
See page 3 for special order finish options.

Pioneer showerheads meet ANSI/ASME A112.18.1 flow requirements of maximum 1.75 GPM

DEL MAR // Tub & Shower





TWO HANDLE ROMAN TUB TRIM SETS

	Model#	Description	Finish	Case	Price
	4DM610T	Two Handle Roman Tub Trim Set Metal Lever Handles	Polished Chrome	6	\$227.00
	4DM610T-BN	Rigid C Style Spout 7-1/2" Reach 3-Hole 8" to 16" Installation For Use with 4300B Valve - Valve not included	PVD Brushed Nickel	6	\$245.00
PARTS	X-1400002	Lever Handle	Polished Chrome	---	\$29.45
	X-4400014	Handle Escutcheon	Polished Chrome	---	\$35.00
	X-4900024	3/32" Allen Wrench	---	---	\$1.30
	X-2400003	'C' Spout	Polished Chrome	---	\$202.00
	X-4900002	3/32" Allen Screw	---	---	\$1.30
	X-4900026	1/8" Allen Wrench	---	---	\$0.80
	X-4400017	Spout Hole Cover	Polished Chrome	---	\$1.30
	X-4400018	1/8" Allen Screw	---	---	\$0.80
	X-4400016	Flow Streamer	Polished Chrome	---	\$7.40
	X-4400015	"C" Spout Escutcheon	Polished Chrome	---	\$41.00



See page 3 for special order finish options.

AMERICANA // Kitchen Faucets

TWO HANDLE KITCHEN FAUCETS

	Model#	Description	Finish	Case	Price
	2AM400	Two Handle Kitchen Faucet Metal Lever Handles	Polished Chrome	6	\$376.00
	2AM400-BN	Spout Swivel 360°	PVD Brushed Nickel	6	\$408.40
	2AM400-ORB	8-11/16" Reach, 10-1/4" from Deck to Aerator Ceramic Disc Cartridges 1-Hole Installation Easy-Install 30" Flex Supply Lines With 3/8" Connections With 1.5 GPM Flow Rate	Oil Rubbed Bronze	6	\$427.00
	2AM401	Two Handle Kitchen Faucet Metal Lever Handles	Polished Chrome	6	\$490.00
	2AM401-BN	Spout Swivel 360°	PVD Brushed Nickel	6	\$534.40
	2AM401-ORB	8-11/16" Reach, 10-1/4" from Deck to Aerator Ceramic Disc Cartridges 2- Hole Installation Side Spray Assembly Easy-Install 30" Flex Supply Lines With 3/8" Connections With 1.5 GPM Flow Rate	Oil Rubbed Bronze	6	\$563.00
	2AM500	Two Handle Kitchen Bridge Faucet Metal Lever Handles	Polished Chrome	6	\$386.00
	2AM500-BN	Spout Swivel 360° 8-11/16" Reach, 9-7/16" from Deck to Aerator Ceramic Disc Cartridges 3-Hole 8" Installation With 1.5 GPM Flow Rate	PVD Brushed Nickel	6	\$407.00
	2AM501	Two Handle Kitchen Bridge Faucet Metal Lever Handles	Polished Chrome	6	\$500.00
	2AM501-BN	Spout Swivel 360°	PVD Brushed Nickel	6	\$532.00
	2AM501-ORB	8-11/16" Reach, 9-7/16" from Deck to Aerator Ceramic Disc Cartridges	Oil Rubbed Bronze	6	\$573.00
	2AM501-MZ	4-Hole 8" Installation Side Spray Assembly With 1.5 GPM Flow Rate	Moroccan Bronze	6	\$573.00

TWO HANDLE POT FILLERS

	Model#	Description	Finish	Case	Price
	2AM600	Wall Mount Pot Filler Metal Lever Handles	Polished Chrome	6	\$364.70
	2AM600-BN	Space Saving Swivel Spout (Folds in When Not in Use)	PVD Brushed Nickel	6	\$381.10
	2AM600-SS	21-7/8" Spout Reach	PVD Stainless Steel	6	\$381.10
	2AM600-ORB	Ceramic Disc Cartridges 1-Hole Wall Mount Installation	Oil Rubbed Bronze	6	\$396.00
	2AM600-MZ	Designed for Cold Water 1/2" IPS Connection with Flange	Moroccan Bronze	6	\$396.00
	2AM700	Deck Mount Pot Filler Metal Lever Handles	Polished Chrome	6	\$459.00
	2AM700-BN	Space Saving Swivel Spout (Folds in When Not in Use)	PVD Brushed Nickel	6	\$490.00
	2AM700-ORB	19-3/8" Reach 15-1/4" From Deck to Aerator Ceramic Disc Cartridges 1-Hole Deck Mount Installation Designed for Cold Water 3/8" Compression SS Flex Connector Line	Oil Rubbed Bronze	6	\$527.00

Low flow aerators available upon request.
See page 3 for special order finish options.

Pioneer faucets feature aerators that meet ANSI/ASME A112.18.1 flow requirements of 1.5 GPM

AMERICANA // Kitchen Faucets



TWO HANDLE KITCHEN FAUCETS & POT FILLERS

	Model#	Description	Finish	Case	Price
PARTS	X-1200007C	Handle Set-Cold	Polished Chrome	---	\$48.00
	X-1200007H	Handle Set-Hot	Polished Chrome	---	\$48.00
	X-1200008C	Handle Set-Cold	Polished Chrome	---	\$51.00
	X-1200008H	Handle Set-Hot	Polished Chrome	---	\$51.00
	X-1200009	Handle Set	Polished Chrome	---	\$55.00
	X-1200010	Secondary Handle Set	Polished Chrome	---	\$27.45
	X-2200012	Spout Set	Polished Chrome	---	\$165.00
	X-2200013	Spout Set	Polished Chrome	---	\$167.00
	X-3200004C	Ceramic Stem-Cold	---	---	\$24.40
	X-3200004H	Ceramic Stem-Hot	---	---	\$24.40
	X-4200016	Diverter Piston	---	---	\$8.09
	X-4200059	Side Spray	Polished Chrome	---	\$121.00
	X-4900041	Aerator-2.0 GPM-Male	Polished Chrome	---	\$4.85
	X-4900089	Aerator-1.5 GPM-Male	Polished Chrome	---	\$6.60
	X-4900072	Aerator-1.0 GPM-Male	Polished Chrome	---	\$7.65
	X-4900073	Aerator-0.5 GPM-Male	Polished Chrome	---	\$14.75
	X-4900091	Aerator-1.5 GPM-Female	Polished Chrome	---	\$12.95
	X-4900092	Aerator-1.0 GPM-Female	Polished Chrome	---	\$9.90
	X-4900093	Aerator-0.5 GPM-Female	Polished Chrome	---	\$17.55

AMERICANA

AMERICANA // Lavatory Faucets

TWO HANDLE LAVATORY FAUCETS

		Model#	Description	Finish	Case	Price
		3AM400	Two Handle Lavatory Widespread Faucet Metal Lever Handles	Polished Chrome	6	\$381.00
		3AM400-BN	Rigid Spout	PVD Brushed Nickel	6	\$407.00
		3AM400-ORB	6-11/16" Reach, 5" from Deck to Aerator Ceramic Disc Cartridges	Oil Rubbed Bronze	6	\$438.00
		3AM400-MZ	3-Hole 6" to 16" Installation Brass Pop-Up Drain Assembly With 1.5 GPM Flow Rate	Moroccan Bronze	6	\$438.00
PARTS	X-1300004C	Lever Handle-Cold	Polished Chrome	---	\$45.00	
	X-1300004H	Lever Handle-Hot	Polished Chrome	---	\$45.00	
	X-4900037	Bonnet Nut	---	---	\$1.95	
	X-4900038	Bonnet Nut Gasket	---	---	\$1.30	
	X-3900004C	Ceramic Stem-Cold	---	---	\$11.60	
	X-3900004H	Ceramic Stem-Hot	---	---	\$11.60	
	X-4300018	Deck Plate Mounting Gasket	---	---	\$1.30	
	X-4900008	Mounting Kit	---	---	\$1.30	
	X-4900004	Supply Nut	---	---	\$3.30	
	X-6300005	Brass Pop-Up Drain Assembly	Polished Chrome	---	\$49.00	
	X-4900042C	Handle Button-Cold	Polished Chrome	---	\$2.30	
	X-4900042H	Handle Button-Hot	Polished Chrome	---	\$2.30	
	X-4900036	Handle Screw	---	---	\$1.30	
	X-4900091	Female 55/64" Thread Aerator-1.5 GPM	Polished Chrome	---	\$12.95	
	X-1900007C	Lever Handle-Cold	Polished Chrome	---	\$47.00	
	X-1900007H	Lever Handle-Hot	Polished Chrome	---	\$47.00	
	X-4900034	Handle Escutcheon	Polished Chrome	---	\$15.75	
	X-5900001	Valve Mounting Kit	---	---	\$7.15	
	X-4900022	Bonnet Nut	---	---	\$4.35	
	X-4300015	Cross Connector	---	---	\$11.45	
	X-5300005	Spout Locknut Set	---	---	\$2.30	
	X-2300003	Spout Set	Polished Chrome	---	\$172.00	
	X-6300020	Brass Pop-Up Drain Assembly	Polished Chrome	---	\$54.00	
	X-4900035	Handle Screw	Polished Chrome	---	\$1.30	
	X-4900032	Spout Escutcheon	Polished Chrome	---	\$11.95	

Low flow aerators available upon request.
See page 3 for special order finish options.

Pioneer faucets feature aerators that meet ANSI/ASME A112.18.1 flow requirements of 1.5 GPM

AMERICANA // Tub & Shower

TUB & SHOWER TRIM SETS

	Model#	Description	Finish	Case	Price
	4AM100T	Single Handle Tub and Shower Trim Set Metal Lever Handle	Polished Chrome	6	\$386.00
	4AM100T-BN	Ceramic Disc Cartridge with Temperature Limit Stop Single Function 3-1/2" Diameter Showerhead	PVD Brushed Nickel	6	\$404.70
	4AM100T-ORB	13" Long Shower Arm and Flange Combo 1/2" IPS/Slip-On Diverter Tub Spout Tub Spout Escutcheon Color Match Sleeve and Retaining Ring With 1.75 GPM Flow Rate For Use with 4020B Valve - Valve not included	Oil Rubbed Bronze	6	\$445.80
	X-4400065	Spout Escutcheon	Polished Chrome	---	\$27.45
	X-6400004	Showerhead	Polished Chrome	---	\$123.00
	X-6400005	Shower Arm	Polished Chrome	---	\$56.00
	X-6400006	Shower Arm Flange	Polished Chrome	---	\$21.35
	X-6400007	Face Plate	Polished Chrome	---	\$47.00
	X-6400008	Combo 1/2" IPS/Slip-On Diverter Tub Spout	Polished Chrome	---	\$40.00
	X-6400022	Combo 1/2" IPS/Slip On Tub Spout	Polished Chrome	---	\$28.45
X-6400097	Showerhead-1.75 GPM	Polished Chrome	---	\$124.65	
X-1400029	Handle Set	Polished Chrome	---	\$87.00	





Low flow showerheads available upon request.
See page 3 for special order finish options.

Pioneer showerheads meet ANSI/ASME A112.18.1 flow requirements of maximum 1.75 GPM

AMERICANA

BRENTWOOD // Lavatory Faucets

TWO HANDLE LAVATORY FAUCETS

	Model#	Description	Finish	Case	Price
	3BR400	Two Handle Lavatory Widespread Faucet Metal Lever Handles	Polished Chrome	6	\$276.00
	3BR400-BN	Rigid J Style Spout	PVD Brushed Nickel	6	\$292.00
	3BR400-ORB	4-9/16" Reach, 4-1/2" from Deck to Aerator Ceramic Disc Cartridges 3-Hole 6" to 16" Installation Brass Pop-Up Drain Assembly Includes Spout and Valve Escutcheons With 1.2 GPM Flow Rate	Oil Rubbed Bronze	6	\$318.00
	3BR410	Two Handle Lavatory Widespread Faucet Porcelain Lever Handles	Polished Chrome	6	\$276.00
	3BR410-BN	Rigid J Style Spout 4-9/16" Reach, 4-1/2" from Deck to Aerator Ceramic Disc Cartridges 3-Hole 6" to 16" Installation Brass Pop-Up Drain Assembly Includes Spout and Valve Escutcheons With 1.2 GPM Flow Rate	PVD Brushed Nickel	6	\$292.00
	3BR300	Two Handle Lavatory Faucet Metal Lever Handles	Polished Chrome	6	\$142.00
	3BR300-BN	Gooseneck Spout Swivel 360°	PVD Brushed Nickel	6	\$157.00
	3BR300-ORB	4-7/8" Reach, 4-9/16" from Deck to Aerator Ceramic Disc Cartridges 3-Hole 4" Installation Brass Pop-Up Drain Assembly With 1.2 GPM Flow Rate	Oil Rubbed Bronze	6	\$166.00
	3BR300-E1.0	With 1.0 GPM Flow Rate	Polished Chrome	6	\$145.00
	3BR310	Two Handle Lavatory Faucet Porcelain Lever Handles	Polished Chrome	6	\$142.00
	3BR310-BN	Gooseneck Spout Swivel 360° 4-7/8" Reach, 4-9/16" from Deck to Aerator Ceramic Disc Cartridges 3-Hole 4" Installation Brass Pop-Up Drain Assembly With 1.2 GPM Flow Rate	PVD Brushed Nickel	6	\$157.00

Low flow aerators available upon request.
See page 3 for special order finish options.

Pioneer faucets feature aerators that meet ANSI/ASME A112.18.1 flow requirements of 1.5 GPM

BRENTWOOD // Lavatory Faucets

TWO HANDLE LAVATORY FAUCETS

	Model#	Description	Finish	Case	Price
PARTS	X-1900009C	Lever Handle-Cold	Polished Chrome	---	\$29.45
	X-1900009H	Lever Handle-Hot	Polished Chrome	---	\$29.45
	X-1900010C	Porcelain Lever Handle-Cold	Polished Chrome	---	\$18.30
	X-1900010H	Porcelain Lever Handle-Hot	Polished Chrome	---	\$18.30
	X-1900011C	Porcelain Cross Handle-Cold	Polished Chrome	---	\$16.25
	X-1900011H	Porcelain Cross Handle-Hot	Polished Chrome	---	\$16.25
	X-1900012C	Beaux Lever Handle-Cold	Polished Chrome	---	\$21.35
	X-1900012H	Beaux Lever Handle-Hot	Polished Chrome	---	\$21.35
	X-2300008	11" Spout Set	Polished Chrome	---	\$137.00
	X-2300009	C Spout Set	Polished Chrome	---	\$132.00
	X-3300002C	Ceramic Stem-Cold	---	---	\$13.20
	X-3300002H	Ceramic Stem-Hot	---	---	\$13.20
	X-3900002C	Ceramic Stem-Cold	---	---	\$10.70
	X-3900002H	Ceramic Stem-Hot	---	---	\$10.70
	X-6300008	Brass Pop-Up	Polished Chrome	---	\$41.00
	X-4900081	Aerator-1.5 GPM-Male	Polished Chrome	---	\$8.90
	X-4900082	Aerator-1.0 GPM-Male	Polished Chrome	---	\$9.40
	X-4900083	Aerator-0.5 GPM-Male	Polished Chrome	---	\$13.20
	X-4900091	Aerator-1.5 GPM-Female	Polished Chrome	---	\$12.95
	X-4900092	Aerator-1.0 GPM-Female	Polished Chrome	---	\$9.90
	X-4900093	Aerator-0.5 GPM-Female	Polished Chrome	---	\$17.55
	X-4900095	Aerator-1.5 GPM-Female	Polished Chrome	---	\$12.20
	X-4900096	Aerator-1.0 GPM-Female	Polished Chrome	---	\$9.15
	X-4900097	Aerator-0.5 GPM-Female	Polished Chrome	---	\$16.25

Low flow aerators available upon request.

Pioneer faucets feature aerators that meet ANSI/ASME A112.18.1 flow requirements of 1.5 GPM

PIONEER // Accessories

SHOWERHEADS







	Model#	Description	Finish	Case	Price
	X-6400045	Four Function Showerhead Rub-Clean Anti-Scale Spray	Polished Chrome	---	\$44.00
	X-6400045-BN	Brass Ball Swivel Joint 3-3/8" Face With 1.5 GPM Flow Rate	PVD Brushed Nickel	---	\$46.00
	X-6400081	Single Function Standard Showerhead Rub-Clean Anti-Scale Spray	Polished Chrome	---	\$25.40
	X-6400081-BN	Brass Ball Swivel Joint 3-3/8" Diameter With 1.75 GPM Flow Rate	PVD Brushed Nickel	---	\$39.00
	X-6400052	Single Function Standard Showerhead Rub-Clean Anti-Scale Spray	Polished Chrome	---	\$32.50
	X-6400052-BN	Brass Ball Swivel Joint 3-3/8" Diameter With 1.5 GPM Flow Rate	PVD Brushed Nickel	---	\$39.00
	X-6400055	Single Function Rain Showerhead Rub-Clean Anti-Scale Spray	Polished Chrome	---	\$55.00
	X-6400055-BN	Offset Brass Ball Swivel Joint 6" Diameter With 1.5 GPM Flow Rate	PVD Brushed Nickel	---	\$58.00
	X-6400036	Dual Function Showerhead Brass Ball Swivel Joint Side Spray Adjustment 3-1/2" Diameter With 2.5 GPM Flow Rate	Polished Chrome	---	\$102.00
	X-6400014	Dual Function Showerhead Brass Ball Swivel Joint Side Spray Adjustment 2-1/2" Diameter With 2.5 GPM Flow Rate	Polished Chrome	---	\$52.00

Low flow showerheads available upon request.
See page 3 for special order finish options.

Pioneer showerheads meet ANSI/ASME A112.18.1 flow requirements of maximum 1.75 GPM

PIONEER // Accessories

SHOWERHEADS

	Model#	Description	Finish	Case	Price
	X-6400078*	Single Function 6" Square Rain Showerhead Rub-Clean Anti-Scale Spray Brass Ball Swivel Joint 1.5 GPM Flow Rate	Polished Chrome	---	\$121.00
	X-6400012	Single Function Rain Showerhead Rub-Clean Anti-Scale Spray Brass Ball Swivel Joint 8" Diameter With 2.5 GPM Flow Rate	Polished Chrome	---	\$202.00
	X-6400108	With 1.75 GPM Flow Rate	Polished Chrome	---	\$202.00
	X-6400013	15" L Shape Shower Arm And Shower Arm Flange	Polished Chrome	---	\$64.00
	X-6400038	Single Function Rain Showerhead Rub-Clean Anti-Scale Spray Brass Ball Swivel Joint 8" Diameter 15" L Shape Shower Arm And Shower Arm Flange With 2.5 GPM Flow Rate	Polished Chrome	---	\$266.00
	X-6400095	Five Function Showerhead Rub-Clean Anti-Scale Spray Brass Ball Swivel Joint 3" Diameter With 1.75 GPM Flow Rate	Polished Chrome	---	\$60.00
	X-6400097	Single Function Showerhead Rub-Clean Anti-Scale Spray Brass Ball Swivel Joint 3-1/2" Diameter With 1.75 GPM Flow Rate	Polished Chrome	---	\$124.65









Low flow showerheads available upon request.
See page 3 for special order finish options.

Pioneer showerheads meet ANSI/ASME A112.18.1 flow requirements of maximum 1.75 GPM

ACCESSORIES

PIONEER // Accessories

DRAINS - WASTE & OVERFLOW

	Model#	Description	Finish	Case	Price
	X-6400029	Bath Waste & Overflow-Tip-Toe Bath Strainer; 1-1/2" Coarse Thread	Polished Chrome	---	\$24.40
	X-6400029-BN		PVD Brushed Nickel	---	\$25.40
	X-6400029-ORB		Oil Rubbed Bronze	---	\$27.45
	X-6400030	Bath Waste & Overflow-Lift & Lock Strainer; 1-1/2" Coarse Thread	Polished Chrome	---	\$20.30
	X-6400030-BN		PVD Brushed Nickel	---	\$21.35
	X-6400030-ORB		Oil Rubbed Bronze	---	\$24.40
	X-6400031	Bath Waste & Overflow-Trip Lever Face Plate With Screws	Polished Chrome	---	\$16.00
	X-6400031-BN		PVD Brushed Nickel	---	\$16.75
	X-6400031-ORB		Oil Rubbed Bronze	---	\$19.30
	X-6400032	Bath Waste & Overflow-2-Hole Face Plate With Screws	Polished Chrome	---	\$10.70
	X-6400032-BN		PVD Brushed Nickel	---	\$11.95
	X-6400032-ORB		Oil Rubbed Bronze	---	\$13.45
	X-6400033	Bath Waste & Overflow-1-Hole Face Plate With Screw	Polished Chrome	---	\$9.90
	X-6400033-BN		PVD Brushed Nickel	---	\$10.70
	X-6400033-ORB		Oil Rubbed Bronze	---	\$11.20
	X-6400034	Bath Waste & Overflow-Grid Strainer With Screw	Polished Chrome	---	\$8.40
	X-6400034-BN		PVD Brushed Nickel	---	\$9.15
	X-6400034-ORB		Oil Rubbed Bronze	---	\$9.90
	X-6300010	Push Down Drain Without Overflow	Polished Chrome	---	\$65.00
	X-6300011	Push Down Drain With Overflow	Polished Chrome	---	\$65.00

See page 3 for special order finish options.





PIONEER // Valves

ROMAN TUB AND VESSEL FILLER VALVES

	Model#	Description	Finish	Case	Price
	4300B	Two Handle Roman Tub Valve Set 1/2" IPS Connections Quick Mount Connector Deck or Ledge Mount Ceramic Disc Cartridges 3-Hole 8" to 16" Installation Brass Plug 12" SS Flex Hose, Mud Guards Included	---	12	\$146.00

PIONEER // Valves





PRESSURE BALANCE TUB & SHOWER VALVES

	Model#	Description	Finish	Case	Price
	4020B	Single Handle Pressure Balance Tub and Shower Valve Set Combo CXC and IPS Inlet and Outlet Connections Cartridge, Sleeve, Locknut and Retaining Ring Ship with Trim Kit Brass Inlet Stops Back to Back Installation	---	12	\$68.00
	4020B-B*	Builder Tract Pack	---	12	\$66.00
	4020B-D	Single Handle Tub and Shower with Diverter Valve Set Combo CXC and IPS Inlet and Outlet Connections Cartridge, Sleeve, Locknut and Retaining Ring Ship with Trim Kit Brass Inlet Stops Back to Back Installation Includes Three-Way Diverter Valve	---	6	\$151.00
	4021B	Single Handle Pressure Balance Tub and Shower Valve Set 1/2" PEX Inlet & Shower Outlet W/Combo CXC & IPS Tub Outlet Cartridge, Sleeve, Locknut, Retaining Ring Ship with Trim Kit Brass Inlet Stops Back to Back Installation	---	12	\$88.00
	4021B-B*	Builder Tract Pack	---	12	\$86.00
	4022B	Single Handle Pressure Balance Tub and Shower Valve Set 1/2" PEX Inlet & Shower Outlet W/Combo CXC & IPS Tub Outlet Cartridge, Sleeve, Locknut, Retaining Ring Ship with Trim Kit Brass Inlet Stops Back to Back Installation	---	12	\$88.00
	4022B-B*	Builder Tract Pack	---	12	\$86.00
	4023B	Single Handle Pressure Balance Tub and Shower Valve Set 1/2" CPVC Inlet W/Combo CXC & IPS Outlet Cartridge, Sleeve, Locknut, Retaining Ring Ship with Trim Kit Brass Inlet Stops Back to Back Installation	---	12	\$88.00
	4023B-B*	Builder Tract Pack	---	12	\$86.00

*Builder Tract Packs sold in case quantities only.

PIONEER // Valves



PRESSURE BALANCE TUB & SHOWER VALVES

	Model#	Description	Finish	Case	Price
	4024B	Single Handle Pressure Balance Tub and Shower Valve Set 1/2" PEX Inlet & Shower Outlet W/Copper Stub Tub Outlet Cartridge, Sleeve, Locknut, Retaining Ring Ships With Trim Kit Brass Inlet Stops Back to Back Installation	---	6	\$96.00
	4024B-B*	Builder Tract Pack	---	6	\$93.00
	4025B	Single Handle Pressure Balance Tub and Shower Valve Set 1/2" PEX Inlet W/Combo CXC & IPS Outlet Cartridge, Sleeve, Locknut, Retaining Ring Ships With Trim Kit Brass Inlet Stops Back to Back Installation	---	12	\$82.00
	4025B-B*	Builder Tract Pack	---	12	\$80.00
	4027B	Single Handle Pressure Balance Tub and Shower Valve Set 1/2" Uponor PEX Inlet W/Combo CXC & IPS Outlet Cartridge, Sleeve, Lock nut, Retaing Ring Ships With Trim Kit Brass Inlet Stops Back to Back Installation	---	12	\$85.00
	4027B-B*	Builder Tract Pack	---	12	\$83.00
	4100B	Single Handle Diverter Valve Set Combo CXC and IPS Connections Three Way Diverter Valve Ceramic Disc Cartridge	---	12	\$83.00

*Builder Tract Packs sold in case quantities only.

PIONEER // Ceramic Disc Cartridges

CERAMIC DISC CARTRIDGES

	Model#	Where Used	Price	
	X-3200001	Kitchen	\$16.00	
		Tub & Shower		
		2BL220		4MT710
		2CL250		4MT711
		2GB250		4MT720
		2LG220		
		2MT250		
	X-3400002	Tub & Shower	\$12.70	
		990512		
	X-3400003	Valves	\$21.10	
		1910B		

CERAMIC DISC CARTRIDGES





	Model#	Where Used	Price		
	X-3400007	Kitchen	\$49.00		
		Tub & Shower			
		Tub & Shower			
		4AM100T		4BR330T	4LG100T
		4AM200T		4CB100T	4LG300T
		4AM300T		4CB200T	4MT100T
		4AM400T		4CB300T	4MT110T
		4BL100T		4CB400T	4MT120T
		4BL200T		4CL100T	4MT200T
		4BL300T		4CL200T	4MT300T
		4BL400T		4CL300T	4MT320T
		4BR100T		4CS100T	4MT400T
		4BR110T		4CS200T	4PR100T
		4BR120T		4CS300T	4PR110T
		4BR130T		4DM100T	4PR300T
		4BR200T		4DM200T	4PR310T
		4BR210T		4DM300T	4PR400T
		4BR220T		4DM400T	Valves
		4BR230T		4GB100T	4020B
		4BR300T		4GB110T	
		4BR310T		4GB300T	
		4BR320T		4GB310T	

REPLACEMENT PARTS KIT

	Model#	Description	Price
	X-4900117	Genuine Pioneer Product's Repair Parts	\$399.00

PIONEER // Ceramic Disc Cartridges

CERAMIC DISC CARTRIDGES

Model#		Where Used		Price	Model#		Where Used			Price
	X-3600001	Valves		\$22.35		X-3900003	Kitchen	Lavatory	Lavatory	\$12.95
		199731B						2MT170H	3LG160	
							2MT171H	3LG161	3MT180	
								3LG170	3MT181	
								3LG171	3MT181G	
								3LG180		
	X-3600003	Tub & Shower		\$19.97		X-3900001	Kitchen	Kitchen	Lavatory	\$13.20
		6AM101T	4020B-D				2LG160	2MT340	3MT160	
		6CB101T	4100B				2LG160H	2MT341	3MT161	
		6CS101T					2LG161	2PM160	3MT161G	
		6DM101T					2LG161H	2PM161	3MT166	
		6GB101T					2LG162	2VL160	3MT168	
		6LG101T					2LG170	2VL161	3MT170	
		6PR101T					2LG171	2VL260	3MT171	
		4020B-D					2LG250	2VL261	3MT171G	
		4100B					2LG260	Tub & Shower	3MT176	
							2LG261		3MT178	
		2MT160H	4MT840	3MT800						
		2MT161H	4MT840	3PM160						
		2MT330		Valves						
		2MT331		4200B						

CARTRIDGES

PIONEER // Ceramic Stems & Washerless Cartridges



CERAMIC STEM

	Model#	Where Used	Price
	X-3200003	Kitchen	\$14.00
		2PM440	
		2PM540	

WASHERLESS CARTRIDGE

	Model#	Where Used	Price
	X-3400001	Valves	\$9.40
		4010B	
		4011B	

CERAMIC STEM - COLD, HOT

	Model#	Where Used	Price
	X-3200004C X-3200004H	Kitchen	\$24.40
		2AM400	
		2AM401	
		2AM500	
		2AM501	
	X-3900004C X-3900004H	Kitchen	\$11.60
		2AM100	
		2AM101	
		2AM200	
		2AM201	

DIVERTER PISTON

	Model#	Where Used	Price		
	X-3900002C X-3900002H	Kitchen	\$10.70		
		2BR100		5DM100	3LG111
		2BR101		5LG120	3LG121
		2BR110		5LG220	3LG121G
		2BR111		Lavatory	3LG130
		2BR120		3BL100	3MT100
		2BR121		3BL200	3MT110
		2BR130		3BR100	3MT400
		2BR131		3BR110	3MT500
		2BR200		3BR120	3PR200
		2BR201		3BR130	Tub & Shower
		2BR210		3BR200	
		2BR211		3BR210	4AM610
		2BR220		3BR220	4AM611
		2BR221		3BR230	4BR600
		2BR230		3BR300	4BR610
		2BR231		3BR310	4BR620
		2CB200		3BR320	4BR630
		2CB201		3BR330	4BR700
		2DM100		3BR400	4BR710
		2DM101		3BR410	4BR720
		2DM200		3BR420	4BR730
		2DM201		3BR430	4BR800
		2DM300		3BR500	4BR810
		2DM301		3BR510	4BR820
		2LG100		3BR520	4BR830
		2LG101		3BR530	4GB611
		2LG110		3CB100	4MT610
		2LG111		3CB101	4MT611
		2LG120		3CB200	4MT620
2LG230	3DM100	Valves			
2LG231	3DM101	4300B			
2LG240	3DM200				
2MT200	3DM300				
2MT201	3GB100				
2MT210	3GB200				
2MT211	3LG100				
2PR200	3LG101				
2PR201	3LG110				

PIONEER // Diverter Pistons, Pressure Balance, Spools & Associated Cartridge Parts

CERAMIC STEM

	Model#	Where Used		Price
	X-3200002	Kitchen	Bar	\$3.30
		2PM330	5PM330	
2PM331				

CAM & PACKING

	Model#	Where Used		Price
	X-4200046	Kitchen	Bar	\$2.30
		2PM330	5PM330	
2PM331				

SPRINGS & SEATS

	Model#	Where Used		Price
	X-4900019	Kitchen	Bar	\$1.30
		2PM330	5PM330	
		2PM331	Valve	
			4010B	
		4011B		

DIVERTER PISTON

	Model#	Where Used		Price
	X-4200007	Kitchen		\$2.30
		2LG161	2LG261	
		2LG161H	2MT161H	
		2LG162	2PM161	
		2LG171	2PM331	

DIVERTER PISTON

	Model#	Where Used			Price
	X-4200016	Kitchen	Kitchen	Kitchen	\$8.09
		2AM101	2BR231	2MT171H	
		2AM201	2CB201	2MT201	
		2AM401	2CL331	2MT211	
		2AM501	2CS201	2MT331	
		2BR101	2CS331	2MT341	
		2BR111	2DM101	2PR201	
		2BR121	2DM201		
		2BR131	2DM301		
		2BR201	2LG101		
		2BR211	2LG111		
		2BR221	2LG231		

PRESSURE BALANCE SPOOL

	Model#	Where Used			Price
	X-4400005	Valves			\$44.00
		4010B	1910B		
		4011B			

PRESSURE BALANCE SPOOL

	Model#	Where Used			Price
	X-4400070	Kitchen			\$36.00
990512					

MISC. PARTS

PIONEER // Extensions & Adapters

EXTENSION LENGTH: 1/2"

Model#	Where Used			Price
	Kitchen	Kitchen	Lavatory	
X-4200155	2AM101	2BR221	2LG231	\$7.65
	2AM201	2BR231	2MT161H	
	2AM401	2CB201	2MT171H	
	2AM501	2CS201	2MT201	
	2BR101	2CS331	2MT211	
	2BR111	2DM101	2MT331	
	2BR121	2DM201	2MT341	
	2BR131	2DM301	2PR201	
	2BR201	2LG101	2VL161	
	2BR211	2LG111	2VL261	



EXTENSION LENGTH: 1/2"

Model#	Where Used			Price
	Kitchen	Lavatory	Lavatory	
X-4900105	2LG100	3BR110	3GB100	\$7.84
	2LG101	3BR120	3LG100	
	2LG110	3BR130	3LG101	
	2LG111	3BR200	3LG110	
	2LG120	3BR210	3LG111	
	2LG230	3BR220	3LG121	
	2LG231	3BR230	3LG121G	
	2LG240	3BR300	3LG130	
	Bar	3BR310	3MT100	
	5LG120	3BR320	3MT110	
	5LG220	3BR330	3PR100	
	Lavatory	3CB100		
	3AM100	3CB101		
	3BL100	3DM100		
	3BR100	3DM101		



EXTENSION LENGTH: 1"

Model#	Where Used	Price
X-4400088	Valves	\$38.00
	4020B	



IPS TO CXC ADAPTER FOR X-6400051

Model#	Where Used	Price
X-5400008	Tub & Shower	\$3.60
	4MT110T	
	4MT120T	



EXTENSION LENGTH 2"

Model#	Where Used	Price		
X-4400089	Tub & Shower	\$49.00		
	Kitchen			
	4AM610		4BR710	4CL610
	4AM611		4BR720	4CS610
	4BR600		4BR730	4MT610
	4BR610		4BR800	4MT611
	4BR620		4BR810	Valves
	4BR630		4BR820	4300B
	4BR700		4BR830	



IPS TO CXC ADAPTER FOR X-6400024

Model#	Where Used	Price
X-5400009	Tub & Shower	\$5.10
	4MT100T	
	4MT200T	



EXTENSION LENGTH: 1"

Model#	Where Used	Price
X-4600045	Valves	\$20.05
	4100B	



MOUNTING TOOL FOR X-5400008 OR X-5400009

Model#	Where Used	Price
X-5400010	Valves	\$5.85
	4MT100T	
	4MT110T	
	4MT120T	
	4MT200T	



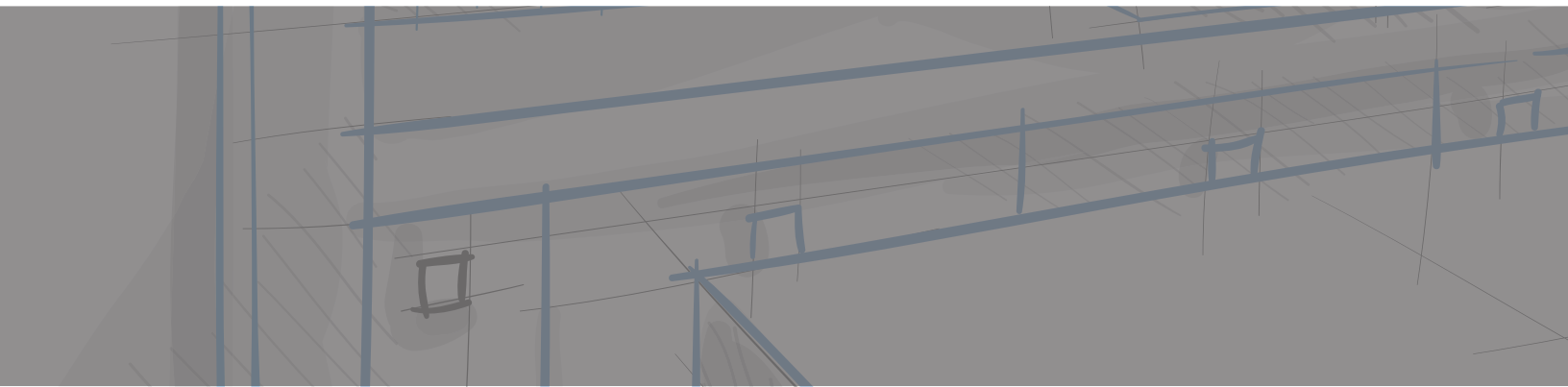



OLYMPIA //

2019 OLYMPIA PRODUCT CATALOG PRICE INDEX

2019 OLYMPIA PRODUCT CATALOG PRICE INDEX

MODEL	PAGE	PCS/CS	LIST PRICE	MODEL	PAGE	PCS/CS	LIST PRICE	MODEL	PAGE	PCS/CS	LIST PRICE
ACS-300100	144	50	\$7.50	K-5020-E1.5	90	6	\$228.00	L-6012	100	12	\$170.00
ACS-300200	144	50	\$10.50	K-5020-E1.5-BN	90	6	\$285.50	L-6012B	100	12	\$168.00
ACS-300400	144	50	\$13.00	K-5025	90	6	\$238.00	L-6012-BN	100	12	\$226.10
ACS-300500	144	50	\$15.50	K-5025-BN	90	6	\$299.00	L-6012-WD	100	12	\$180.00
ACS-903100	145	96	\$7.50	K-5025-MB	90	6	\$314.00	L-6012-WD-BN	100	12	\$240.00
ACS-903100-BN	145	96	\$11.00	K-5030	117	6	\$163.00	L-6013	100	12	\$175.00
ACS-903100-ORB	145	96	\$12.50	K-5030-BN	117	6	\$203.50	L-6020	96	12	\$155.00
ACS-903500	145	25	\$24.00	K-5030-E1.5	117	6	\$165.00	L-6020B	96	12	\$153.00
ACS-903500-BN	145	25	\$33.00	K-5030-E1.5-BN	117	6	\$205.50	L-6020-BN	96	12	\$206.15
B-8150	107	12	\$79.00	K-5030-E1.5-ORB	117	6	\$226.00	L-6020-MB	96	12	\$217.00
B-8150-BN	107	12	\$100.00	K-5030-ORB	117	6	\$224.00	L-6020-WD	96	12	\$163.00
B-8160	107	12	\$74.00	K-5040	104	6	\$225.00	L-6020-WD-BN	96	12	\$216.80
B-8160-BN	107	12	\$93.50	K-5040-BN	104	6	\$281.00	L-6021	96	12	\$137.00
B-8170	124	12	\$75.50	K-5040-E1.5	104	6	\$226.00	L-6021-BN	96	12	\$182.25
B-8171	124	12	\$63.50	K-5040-E1.5-BN	104	6	\$282.00	L-6021-WD	96	12	\$145.00
B-8180	124	12	\$82.00	K-5040-MZ	104	6	\$330.50	L-6021-WD-BN	96	12	\$192.85
B-8181	124	12	\$70.00	K-5040-ORB	104	6	\$314.50	L-6022	96	12	\$160.00
B-8190	125	12	\$76.50	K-5120	120	12	\$72.00	L-6022B	96	12	\$158.00
B-8191	125	12	\$64.50	K-5121	120	12	\$82.00	L-6022-BN	96	12	\$212.80
K-4160	118	12	\$76.00	K-5130	120	12	\$73.50	L-6022-WD	96	12	\$168.00
K-4160B	118	12	\$74.00	K-5131	120	12	\$83.50	L-6022-WD-BN	96	12	\$223.50
K-4160B-BN	118	12	\$102.00	K-5150	120	12	\$78.00	L-6023	96	12	\$165.00
K-4160-BN	118	12	\$104.00	K-5160	121	12	\$79.00	L-6030	88	12	\$147.00
K-4160H	118	12	\$86.00	K-5161	121	12	\$89.00	L-6030B	88	12	\$145.00
K-4160-ORB	118	12	\$116.50	K-5170	121	12	\$84.00	L-6030-BN	88	12	\$196.00
K-4161	118	12	\$90.50	K-5171	121	12	\$94.00	L-6030-MB	88	12	\$235.00
K-4161B	118	12	\$88.50	K-5270	120	12	\$80.50	L-6030-WD	88	12	\$155.00
K-4161B-BN	118	12	\$115.00	K-5271	120	12	\$90.50	L-6030-WD-BN	88	12	\$206.15
K-4161-BN	118	12	\$117.00	K-5340	105	6	\$88.50	L-6031	88	12	\$136.00
K-4161H	118	12	\$100.50	K-5340-BN	105	6	\$128.00	L-6031-BN	88	12	\$184.00
K-4161H-BN	118	12	\$126.50	K-5342	105	6	\$108.00	L-6031-WD	88	12	\$146.00
K-4162	118	12	\$100.00	K-5342-BN	105	6	\$152.50	L-6031-WD-BN	88	12	\$197.00
K-4162B	118	12	\$98.00	K-5342-ORB	105	6	\$171.00	L-6032	88	12	\$152.00
K-4162-BN	118	12	\$129.50	K-5350	105	6	\$93.00	L-6032B	88	12	\$150.00
K-4162H	118	12	\$110.00	K-5370	105	6	\$93.50	L-6032-BN	88	12	\$202.50
K-4163	118	12	\$93.00	K-5370-BN	105	6	\$135.50	L-6032-MB	88	12	\$243.00
K-4164	118	12	\$102.50	K-5372	105	6	\$113.00	L-6032-WD	88	12	\$160.00
K-4170	119	12	\$76.00	K-5372-BN	105	6	\$157.00	L-6032-WD-BN	88	12	\$216.00
K-4170-BN	119	12	\$99.50	K-5441	104	6	\$253.50	L-6033	88	12	\$157.00
K-4171	119	12	\$90.50	K-5441-BN	104	6	\$305.50	L-6050	92	12	\$147.00
K-5010	91	6	\$243.00	L-6010	100	12	\$165.00	L-6050B	92	12	\$145.00
K-5010-BN	91	6	\$310.00	L-6010B	100	12	\$163.00	L-6050B-BN	92	12	\$194.00
K-5010-E1.5	91	6	\$246.00	L-6010-BN	100	12	\$219.45	L-6050B-E0.5	92	12	\$149.00
K-5010-E1.5-BN	91	6	\$313.00	L-6010-MB	100	12	\$325.50	L-6050B-E1.0	92	12	\$149.00
K-5010-MB	91	6	\$325.50	L-6010-WD	100	12	\$175.00	L-6050-BN	92	12	\$196.00
K-5015	91	6	\$256.00	L-6010-WD-BN	100	12	\$233.00	L-6050-MB	92	12	\$211.00
K-5015-BN	91	6	\$326.50	L-6011	100	12	\$147.00	L-6050-WD	92	12	\$155.00
K-5020	90	6	\$225.00	L-6011-BN	100	12	\$195.60	L-6050-WD-BN	92	12	\$206.15
K-5020B	90	6	\$223.00	L-6011-WD	100	12	\$157.00	L-6051	92	12	\$136.00
K-5020-BN	90	6	\$282.50	L-6011-WD-BN	100	12	\$209.00	L-6051-BN	92	12	\$184.00

2019 OLYMPIA PRODUCT CATALOG PRICE INDEX

MODEL	PAGE	PCS/ CS	LIST PRICE	MODEL	PAGE	PCS/ CS	LIST PRICE	MODEL	PAGE	PCS/ CS	LIST PRICE
L-6051-E0.5	92	12	\$139.00	L-6172-BN	127	12	\$106.50	L-7422-BN	97	6	\$245.00
L-6051-E0.5-BN	92	12	\$187.00	L-6174	127	12	\$65.00	L-7422-MB	97	6	\$258.00
L-6051-E1.0	92	12	\$139.00	L-7220	128	12	\$56.50	L-7470	110	6	\$205.00
L-6051-E1.0-BN	92	12	\$187.00	L-7221	128	12	\$46.50	L-7470-BN	110	6	\$240.00
L-6051G	92	12	\$151.00	L-7222	128	12	\$66.50	L-7470-ORB	110	6	\$245.00
L-6051G-BN	92	12	\$204.00	L-7240	108	12	\$74.00	L-7472	110	6	\$210.00
L-6051G-E1.0	92	12	\$154.00	L-7240B	108	12	\$72.00	L-7472-BN	110	6	\$245.00
L-6051G-WD	92	12	\$159.00	L-7240B-BN	108	12	\$92.00	L-7472-ORB	110	6	\$253.00
L-6051G-WD-BN	92	12	\$211.50	L-7240-BN	108	12	\$94.00	L-7570	110	12	\$135.00
L-6051-WD	92	12	\$146.00	L-7240-E1.0	108	12	\$76.00	L-7570B	110	12	\$133.00
L-6051-WD-BN	92	12	\$197.00	L-7240-E1.0-BN	108	12	\$97.00	L-7570B-BN	110	12	\$162.70
L-6052	93	12	\$152.00	L-7240-E1.0-ORB	108	12	\$108.00	L-7570-BN	110	12	\$164.70
L-6052B	93	12	\$150.00	L-7240-ORB	108	12	\$105.00	L-7570-ORB	110	12	\$173.00
L-6052B-BN	93	12	\$200.50	L-7241	108	12	\$64.00	L-7572	110	12	\$140.00
L-6052-BN	93	12	\$202.50	L-7241-BN	108	12	\$77.50	L-7572B	110	12	\$138.00
L-6052-E1.0	93	12	\$155.00	L-7242	108	12	\$82.00	L-7572-BN	110	12	\$170.80
L-6052-E1.0-BN	93	12	\$205.50	L-7242B	108	12	\$80.00	L-7572-ORB	110	12	\$179.40
L-6052-WD	93	12	\$160.00	L-7242-BN	108	12	\$104.00	OP-120001	117	---	\$17.40
L-6052-WD-BN	93	12	\$216.00	L-7242-E1.0	108	12	\$84.00	OP-120002	104	---	\$15.90
L-6053	93	12	\$157.00	L-7242-E1.0-BN	108	12	\$106.50	OP-120003	117	---	\$22.00
L-6160	126	12	\$75.00	L-7242-MZ	108	12	\$120.50	OP-120004	90	---	\$15.00
L-6160B	126	12	\$73.00	L-7242-ORB	108	12	\$114.50	OP-130001	93	---	\$14.00
L-6160B-BN	126	12	\$93.00	L-7251	129	12	\$62.50	OP-130002	100	---	\$18.00
L-6160B-E0.5	126	12	\$75.00	L-7251-E0.5	129	12	\$65.50	OP-130003	96	---	\$16.00
L-6160B-E1.0	126	12	\$76.00	L-7251G	129	12	\$77.50	OP-140004V	136	---	\$9.80
L-6160-BN	126	12	\$95.00	L-7270	108	12	\$79.00	OP-140005V	136	---	\$5.90
L-6160-E0.5	126	12	\$77.00	L-7270-BN	108	12	\$99.00	OP-140006	133	---	\$9.80
L-6160H	126	12	\$76.00	L-7270-E1.0	108	12	\$82.00	OP-140007	116	---	\$32.20
L-6160H-BN	126	12	\$100.00	L-7270-E1.0-BN	108	12	\$102.00	OP-140008	113	---	\$17.90
L-6160-ORB	126	12	\$106.50	L-7271	108	12	\$69.00	OP-140009	114	---	\$10.40
L-6161	126	12	\$66.00	L-7272	108	12	\$84.00	OP-140011	95	---	\$22.00
L-6161-E0.5	126	12	\$68.00	L-7272B	108	12	\$82.00	OP-140014	131	---	\$16.90
L-6161-E1.0	126	12	\$68.00	L-7272-BN	108	12	\$107.50	OP-140015	113	---	\$21.00
L-6161G	126	12	\$81.00	L-7290	128	12	\$60.00	OP-140018	99	---	\$24.00
L-6161G-E0.5	126	12	\$84.00	L-7291	128	12	\$50.00	OP-140019	103	---	\$26.00
L-6161H	126	12	\$67.00	L-7292	128	12	\$69.00	OP-160003	95	---	\$21.00
L-6162	126	12	\$80.00	L-7330	111	6	\$156.00	OP-190001	119	---	\$13.30
L-6162B	126	12	\$78.00	L-7330-BN	111	6	\$199.00	OP-190002	119	---	\$13.30
L-6162B-E0.5	126	12	\$81.00	L-7330-E1.0	111	6	\$159.00	OP-190003C	122	---	\$3.50
L-6162B-E1.0	126	12	\$81.00	L-7330-E1.0-BN	111	6	\$201.00	OP-190003H	122	---	\$3.50
L-6162-BN	126	12	\$106.50	L-7330-ORB	111	6	\$223.00	OP-190004C	122	---	\$4.10
L-6162-E0.5	126	12	\$82.00	L-7332	111	6	\$161.00	OP-190004H	122	---	\$4.10
L-6162-E1.0	126	12	\$82.00	L-7332-BN	111	6	\$208.00	OP-190005C	122	---	\$9.80
L-6162H	126	12	\$81.00	L-7332-ORB	111	6	\$233.00	OP-190005H	122	---	\$9.80
L-6162H-E0.5	126	12	\$86.00	L-7372	111	6	\$166.00	OP-190006C	122	---	\$9.80
L-6162H-E1.0	126	12	\$84.00	L-7372-BN	111	6	\$213.00	OP-190006H	122	---	\$9.80
L-6164	126	12	\$65.00	L-7372-ORB	111	6	\$238.50	OP-190009C	136	---	\$5.90
L-6170	127	12	\$75.00	L-7420	97	6	\$205.00	OP-190009H	136	---	\$5.90
L-6170B	127	12	\$73.00	L-7420-BN	97	6	\$240.00	OP-190010C	106	---	\$13.30
L-6172	127	12	\$80.00	L-7422	97	6	\$210.00	OP-190010H	106	---	\$13.30

2019 OLYMPIA PRODUCT CATALOG PRICE INDEX

MODEL	PAGE	PCS/ CS	LIST PRICE	MODEL	PAGE	PCS/ CS	LIST PRICE	MODEL	PAGE	PCS/ CS	LIST PRICE
OP-190013C	136	---	\$9.80	OP-420015	117	---	\$27.60	OP-430011-BN	147	---	\$13.80
OP-190013H	136	---	\$9.80	OP-420017	117	---	\$0.70	OP-430011-ORB	147	---	\$14.80
OP-190014C	106	---	\$13.30	OP-420018	122	---	\$3.50	OP-430012	147	---	\$10.50
OP-190014H	106	---	\$13.30	OP-420019	122	---	\$0.70	OP-430012-BN	147	---	\$11.60
OP-190015C	106	---	\$14.30	OP-420020	122	---	\$0.70	OP-430012-ORB	147	---	\$12.80
OP-190015H	106	---	\$14.30	OP-420021	122	---	\$4.10	OP-430016	141	---	\$4.80
OP-190016C	97	---	\$17.55	OP-420023	145	---	\$8.40	OP-430017	141	---	\$4.00
OP-190016H	97	---	\$17.55	OP-420024	104	---	\$5.30	OP-430018	141	---	\$4.80
OP-220001	119	---	\$37.30	OP-420025	106	---	\$12.30	OP-430019	141	---	\$1.70
OP-220002	122	---	\$31.70	OP-420026	106	---	\$1.20	OP-430020	141	---	\$1.70
OP-220003	122	---	\$43.40	OP-420037	119	---	\$19.40	OP-430021	93	---	\$6.40
OP-220004	106	---	\$34.70	OP-420038	104	---	\$21.00	OP-430022	93	---	\$3.20
OP-220005	106	---	\$28.60	OP-420039	104	---	\$31.70	OP-430023	93	---	\$1.00
OP-230001	111	---	\$115.30	OP-420040	104	---	\$38.80	OP-430024	93	---	\$5.70
OP-230005	110	---	\$145.00	OP-420041	104	---	\$0.90	OP-430025	93	---	\$0.70
OP-230006	97	---	\$99.00	OP-420042	96	---	\$3.20	OP-430026	96	---	\$16.75
OP-240007	116	---	\$130.10	OP-420043	104	---	\$6.40	OP-430027	110	---	\$11.40
OP-250002	107	---	\$30.10	OP-420044	104	---	\$0.70	OP-430028	110	---	\$0.70
OP-250004	125	---	\$30.10	OP-420045	90	---	\$12.60	OP-430029	110	---	\$0.70
OP-250005	125	---	\$27.10	OP-420046	104	---	\$1.10	OP-430032	100	---	\$7.00
OP-250007	125	---	\$28.60	OP-420047	97	---	\$0.70	OP-430033	100	---	\$1.00
OP-320001	117	---	\$13.80	OP-420048	104	---	\$6.40	OP-430036	97	---	\$11.50
OP-320002	96	---	\$14.80	OP-420049	104	---	\$5.30	OP-430037	97	---	\$11.50
OP-330002C	97	---	\$8.00	OP-420050	104	---	\$2.40	OP-440007	140	---	\$9.20
OP-330002H	97	---	\$8.00	OP-420051	106	---	\$23.00	OP-440008	136	---	\$0.70
OP-340001	136	---	\$15.60	OP-420052	119	---	\$23.00	OP-440009	113	---	\$20.40
OP-340002	136	---	\$13.80	OP-420054	90	---	\$24.00	OP-440010	95	---	\$3.00
OP-340004C	137	---	\$11.60	OP-420055	90	---	\$10.00	OP-440011	113	---	\$2.40
OP-340004H	137	---	\$11.60	OP-420056	90	---	\$0.90	OP-440012	136	---	\$4.60
OP-340006C	114	---	\$4.10	OP-420057	90	---	\$3.20	OP-440013	136	---	\$0.70
OP-340006H	114	---	\$4.10	OP-420058	90	---	\$6.40	OP-440014	136	---	\$1.70
OP-340007	114	---	\$5.90	OP-420059	90	---	\$0.70	OP-440015	114	---	\$4.10
OP-340009	140	---	\$39.30	OP-420060	90	---	\$0.50	OP-440016	114	---	\$4.60
OP-390001	119	---	\$3.50	OP-420061	90	---	\$0.70	OP-440017	114	---	\$1.10
OP-390003	90	---	\$13.00	OP-420062	90	---	\$10.00	OP-440018	133	---	\$21.00
OP-390004	106	---	\$4.60	OP-420063	117	---	\$22.00	OP-440019	133	---	\$2.40
OP-390005	122	---	\$4.60	OP-420064	104	---	\$31.70	OP-440020	133	---	\$3.00
OP-420001	119	---	\$0.70	OP-420067	91	---	\$24.00	OP-440021	140	---	\$3.50
OP-420002	119	---	\$0.70	OP-420069	91	---	\$49.00	OP-440023	140	---	\$0.70
OP-420003	119	---	\$20.40	OP-420070	91	---	\$10.00	OP-440024	140	---	\$1.20
OP-420004	119	---	\$1.80	OP-430001	97	---	\$3.50	OP-440025	137	---	\$18.90
OP-420005	119	---	\$2.40	OP-430005	109	---	\$0.70	OP-440026	137	---	\$11.60
OP-420006	119	---	\$13.80	OP-430006	147	---	\$5.30	OP-440027	116	---	\$5.30
OP-420008	117	---	\$5.30	OP-430007	147	---	\$7.50	OP-440028	116	---	\$0.70
OP-420009	117	---	\$7.60	OP-430007-BN	147	---	\$9.90	OP-440029	116	---	\$0.70
OP-420010	117	---	\$0.70	OP-430007-ORB	147	---	\$11.10	OP-440030	116	---	\$21.50
OP-420011	117	---	\$0.70	OP-430008	141	---	\$2.50	OP-440031	116	---	\$27.10
OP-420012	117	---	\$22.00	OP-430009	141	---	\$2.50	OP-440033	113	---	\$4.10
OP-420013	117	---	\$16.40	OP-430010	127	---	\$1.10	OP-440034	114	---	\$1.80
OP-420014	117	---	\$9.80	OP-430011	147	---	\$8.80	OP-440035	114	---	\$3.50

2019 OLYMPIA PRODUCT CATALOG PRICE INDEX

MODEL	PAGE	PCS/CS	LIST PRICE	MODEL	PAGE	PCS/CS	LIST PRICE	MODEL	PAGE	PCS/CS	LIST PRICE
OP-440036	114	---	\$11.60	OP-490014	122	---	\$0.70	OP-520004	117	---	\$3.00
OP-440037	114	---	\$6.50	OP-490015	122	---	\$0.70	OP-520005	90	---	\$4.20
OP-440042	113	---	\$9.00	OP-490016C	122	---	\$0.70	OP-520006	117	---	\$11.60
OP-440043	99	---	\$1.00	OP-490016H	122	---	\$0.70	OP-520009	106	---	\$3.40
OP-440044	140	---	\$9.90	OP-490017	122	---	\$6.50	OP-520012	90	---	\$5.00
OP-440045	140	---	\$41.90	OP-490018	123	---	\$3.00	OP-520015	91	---	\$4.98
OP-440051	95	---	\$21.00	OP-490019	146	---	\$2.70	OP-530001	127	---	\$3.00
OP-440053	140	---	\$5.00	OP-490025	136	---	\$1.20	OP-530003	141	---	\$4.80
OP-440054	95	---	\$6.00	OP-490026	146	---	\$1.80	OP-530004	141	---	\$3.30
OP-440055	103	---	\$19.00	OP-490027	146	---	\$3.00	OP-530005	93	---	\$5.00
OP-450002	107	---	\$2.40	OP-490028	106	---	\$7.60	OP-540004	137	---	\$8.90
OP-450003	107	---	\$0.70	OP-490029	93	---	\$0.70	OP-540005	137	---	\$9.20
OP-450004	107	---	\$11.00	OP-490030	111	---	\$44.50	OP-540006	137	---	\$18.90
OP-450005	107	---	\$1.80	OP-490035	146	---	\$6.90	OP-560001	115	---	\$1.80
OP-450010	106	---	\$8.70	OP-490035-BN	146	---	\$8.00	OP-590001	106	---	\$1.20
OP-450011	125	---	\$11.00	OP-490035-ORB	146	---	\$9.90	OP-590002	97	---	\$5.90
OP-450012	125	---	\$1.20	OP-490036	116	---	\$0.70	OP-590003	107	---	\$2.40
OP-450013	125	---	\$0.70	OP-490038	106	---	\$0.70	OP-630001	141	---	\$27.60
OP-450014	125	---	\$2.40	OP-490039	106	---	\$0.70	OP-630002	141	---	\$27.10
OP-460001	131	---	\$3.00	OP-490040	106	---	\$2.40	OP-630002-BN	141	---	\$29.60
OP-460002	132	---	\$13.30	OP-490041	106	---	\$1.20	OP-630002-ORB	141	---	\$30.60
OP-460005	132	---	\$9.40	OP-490042	123	---	\$1.20	OP-630004	141	---	\$22.00
OP-460006	95	---	\$32.70	OP-490043	119	---	\$0.70	OP-630004-BN	141	---	\$24.00
OP-460009B/T	115	---	\$22.00	OP-490044	116	---	\$4.60	OP-630004-ORB	141	---	\$25.00
OP-460010	115	---	\$83.20	OP-490045	145	---	\$98.00	OP-630005	93	---	\$26.00
OP-460011	95	---	\$1.10	OP-490055	106	---	\$8.80	OP-630006	93	---	\$29.00
OP-460013	115	---	\$26.10	OP-490055-BN	146	---	\$9.90	OP-630007	96	---	\$34.00
OP-460020	95	---	\$12.30	OP-490055-ORB	146	---	\$11.60	OP-630008	97	---	\$35.00
OP-460021	115	---	\$23.00	OP-490056	146	---	\$9.90	OP-630009	97	---	\$40.00
OP-460022	115	---	\$4.35	OP-490056-BN	146	---	\$11.10	OP-640001	95	---	\$1.20
OP-460026	95	---	\$83.00	OP-490056-ORB	146	---	\$12.60	OP-640002	95	---	\$11.00
OP-460027	95	---	\$22.00	OP-490057	146	---	\$8.80	OP-640003	114	---	\$15.90
OP-490001C	125	---	\$1.20	OP-490057-BN	146	---	\$9.90	OP-640005	143	---	\$5.90
OP-490001H	125	---	\$1.20	OP-490057-ORB	146	---	\$11.10	OP-640005-BN	143	---	\$11.60
OP-490002	119	---	\$0.70	OP-490058	146	---	\$8.80	OP-640007	95	---	\$20.50
OP-490003	119	---	\$7.00	OP-490058-BN	146	---	\$9.90	OP-640008	95	---	\$9.00
OP-490004	119	---	\$4.60	OP-490058-ORB	146	---	\$11.60	OP-640014	142	---	\$9.90
OP-490005	117	---	\$0.70	OP-490059	146	---	\$8.80	OP-640014-BN	142	---	\$16.40
OP-490006	97	---	\$5.30	OP-490059-BN	146	---	\$9.90	OP-640015	142	---	\$15.70
OP-490007	111	---	\$11.40	OP-490059-ORB	146	---	\$11.60	OP-640015-BN	142	---	\$21.50
OP-490008	111	---	\$6.90	OP-490060	146	---	\$11.10	OP-640016	113	100	\$20.40
OP-490009	97	---	\$20.40	OP-490060-BN	146	---	\$12.10	OP-640017	145	---	\$63.80
OP-490010	146	---	\$5.70	OP-490060-ORB	146	---	\$13.10	OP-640017-BN	145	---	\$97.60
OP-490010-BN	146	---	\$7.00	OP-490061	146	---	\$11.10	OP-640017-ORB	145	---	\$101.50
OP-490010-ORB	146	---	\$7.90	OP-490061-BN	146	---	\$12.10	OP-640018	142	50	\$19.90
OP-490011	95	---	\$0.70	OP-490061-ORB	146	---	\$13.10	OP-640018-BN	142	---	\$26.00
OP-490012C	122	---	\$1.20	OP-490062	97	---	\$6.70	OP-640018-ORB	142	---	\$28.20
OP-490012H	122	---	\$1.20	OP-520001	119	---	\$1.80	OP-640019	142	---	\$13.30
OP-490013C	122	---	\$1.20	OP-520002	119	---	\$2.20	OP-640019-BN	142	---	\$22.40
OP-490013H	122	---	\$1.20	OP-520003	90	---	\$2.50	OP-640019-ORB	142	---	\$24.30

2019 OLYMPIA PRODUCT CATALOG PRICE INDEX

MODEL	PAGE	PCS/CS	LIST PRICE	MODEL	PAGE	PCS/CS	LIST PRICE	MODEL	PAGE	PCS/CS	LIST PRICE
OP-640020	132	---	\$13.00	P-1232-BN	134	12	\$136.50	P-2307B	139	12	\$107.00
OP-640022	143	---	\$21.50	P-1250	114	12	\$126.00	P-2307B-B	139	12	\$105.00
OP-640022-BN	143	---	\$32.70	P-1250-BN	114	12	\$187.50	P-2307T	130	12	\$61.50
OP-640022-ORB	143	---	\$35.70	P-2000	133	12	\$76.00	P-2307T-BN	130	12	\$110.00
OP-640024	132	---	\$16.90	P-2002	133	12	\$72.50	P-2308B	139	12	\$109.00
OP-640027	131	---	\$21.00	P-2002-BN	133	12	\$115.50	P-2308B-B	139	12	\$107.00
OP-640029	143	50	\$25.50	P-2230T	89	6	\$78.00	P-2309B	139	6	\$121.00
OP-640029-BN	143	---	\$36.80	P-2230T-BN	89	6	\$87.00	P-2309B-B	139	6	\$119.00
OP-640029-ORB	143	---	\$39.80	P-2240B	137	10	\$29.00	P-2310T	130	12	\$63.00
OP-640031	143	---	\$11.10	P-2240T	115	20	\$24.50	P-2311B	139	6	\$107.00
OP-640031-BN	143	---	\$16.90	P-2240T-BN	115	20	\$47.00	P-2311B-B	139	6	\$105.00
OP-640033	142	---	\$40.80	P-2240T-ORB	115	20	\$60.50	P-2312T	130	12	\$47.00
OP-640033-BN	142	---	\$56.70	P-2270T	94	12	\$78.00	P-2330T	89	6	\$95.00
OP-640034	142	---	\$33.70	P-2270T-BN	94	12	\$87.00	P-2330T-BN	89	6	\$142.50
OP-640034-BN	142	---	\$48.00	P-2280T	99	12	\$78.00	P-2331T	89	6	\$85.00
OP-640035	143	70	\$33.70	P-2280T-BN	99	12	\$87.00	P-2331T-BN	89	6	\$127.50
OP-640035-BN	143	---	\$40.80	P-2290T	102	12	\$78.00	P-2332T	89	6	\$85.00
OP-640035-ORB	143	---	\$43.90	P-2290T-BN	102	12	\$87.00	P-2332T-BN	89	6	\$127.50
OP-640037	95	---	\$53.00	P-2300B	138	12	\$88.00	P-2333T	89	6	\$65.00
OP-640038	143	---	\$30.00	P-2300B-B	138	12	\$86.00	P-2333T-BN	89	6	\$97.50
OP-640039	143	---	\$31.00	P-2300T	130	12	\$60.50	P-2334T	89	6	\$138.50
OP-640040	142	---	\$55.00	P-2300T-ADA	131	4	\$273.50	P-2334T-BN	89	6	\$207.75
OP-640040-BN	142	---	\$69.50	P-2300T-BN	130	12	\$93.00	P-2335T	89	6	\$123.50
OP-640041	143	---	\$49.00	P-2300T-MZ	130	12	\$112.50	P-2335T-BN	89	6	\$185.25
OP-640042	143	---	\$52.00	P-2300T-ORB	130	12	\$107.00	P-2340T	112	12	\$69.00
OP-640043	103	---	\$89.00	P-2301B	138	12	\$104.00	P-2340T-BN	112	12	\$117.50
OP-640044	103	---	\$89.00	P-2301B-B	138	12	\$102.00	P-2340T-MZ	112	12	\$142.00
OP-640045	103	---	\$8.00	P-2301T	130	12	\$44.50	P-2340T-ORB	112	12	\$135.00
OP-640046	103	---	\$23.00	P-2301T-BN	130	12	\$77.00	P-2342T	112	12	\$53.00
OP-640047	143	---	\$53.00	P-2301T-ORB	130	12	\$88.00	P-2342T-BN	112	12	\$94.00
OP-640048	143	---	\$21.00	P-2302B	138	12	\$104.00	P-2342T-MZ	112	12	\$113.50
OP-640053	143	---	\$21.00	P-2302B-B	138	12	\$102.00	P-2342T-ORB	112	12	\$108.00
OP-660003	115	---	\$34.70	P-2302T	130	12	\$44.50	P-2343T	113	12	\$37.00
OP-660005	131	---	\$43.00	P-2302T-ADA	131	4	\$257.50	P-2343T-BN	113	12	\$63.00
OP-660007	95	---	\$43.00	P-2302T-BN	130	12	\$77.00	P-2350T	112	12	\$86.50
OP-660009	115	---	\$43.00	P-2302T-ORB	130	12	\$88.00	P-2350T-BN	112	12	\$141.00
P-1131B	137	12	\$110.00	P-2303B	138	12	\$98.00	P-2351T	112	12	\$70.50
P-1131T	116	6	\$160.00	P-2303B-B	138	12	\$96.00	P-2352T	112	12	\$70.50
P-1131T-BN	116	6	\$192.00	P-2303T	130	12	\$27.50	P-2352T-BN	112	12	\$125.00
P-1131T-MZ	116	6	\$226.00	P-2303T-ADA	131	4	\$187.00	P-2353T	112	12	\$103.00
P-1131T-ORB	116	6	\$215.00	P-2303T-BN	130	12	\$47.00	P-2353T-BN	112	12	\$173.00
P-1171T	99	6	\$165.00	P-2303T-ORB	130	12	\$54.00	P-2354T	112	12	\$81.00
P-1171T-BN	99	6	\$198.00	P-2304B	138	6	\$121.00	P-2354T-BN	112	12	\$135.75
P-1210	134	12	\$84.00	P-2304B-B	138	6	\$119.00	P-2360T	113	12	\$73.00
P-1212	134	12	\$80.50	P-2305B	138	12	\$102.00	P-2360T-BN	113	12	\$120.00
P-1220	134	12	\$81.50	P-2305B-B	138	12	\$100.00	P-2362T	113	12	\$57.00
P-1222	134	12	\$78.00	P-2306B	139	6	\$121.00	P-2362T-BN	113	12	\$98.00
P-1230	134	12	\$121.00	P-2306B-B	139	6	\$119.00	P-2363T	113	12	\$41.00
P-1230-BN	134	12	\$159.00	P-2306T	130	12	\$76.50	P-2370T	94	12	\$95.00
P-1232	134	12	\$108.00	P-2306T-BN	130	12	\$125.00	P-2370T-BN	94	12	\$142.50







2019 OLYMPIA PRODUCT CATALOG PRICE INDEX

MODEL	PAGE	PCS/ CS	LIST PRICE	MODEL	PAGE	PCS/ CS	LIST PRICE
P-2370T-MB	94	12	\$156.00	P-2395T-6-BN	101	12	\$173.40
P-2371T	94	12	\$85.00	P-2395T-BN	101	12	\$150.00
P-2371T-BN	94	12	\$127.50	P-2396T	102	12	\$140.00
P-2372T	94	12	\$85.00	P-2396T-BN	102	12	\$210.00
P-2372T-BN	94	12	\$127.50	P-2397T	102	12	\$120.00
P-2372T-MB	94	12	\$140.00	P-2397T-BN	102	12	\$180.00
P-2373T	94	12	\$65.00	P-2398T	102	12	\$155.00
P-2373T-BN	94	12	\$97.50	P-2398T-6	102	12	\$168.00
P-2374T	94	12	\$138.50	P-2398T-6-BN	102	12	\$252.00
P-2374T-6S	94	12	\$144.00	P-2398T-BN	102	12	\$256.00
P-2374T-BN	94	12	\$207.75	P-2398T-MB	102	12	\$232.50
P-2375T	94	12	\$123.50	P-2400B	140	12	\$83.50
P-2375T-6S	94	12	\$129.00	P-2400B-B	140	12	\$81.50
P-2375T-BN	94	12	\$185.25	P-2403B	140	12	\$90.50
P-2380T	97	12	\$95.00	P-2403B-B	140	12	\$88.50
P-2380T-BN	97	12	\$142.50	P-2405B	140	12	\$96.50
P-2380T-MB	97	12	\$156.00	P-2405B-B	140	12	\$94.50
P-2381T	97	12	\$85.00	P-2407B	140	12	\$102.50
P-2381T-BN	97	12	\$127.50	P-2407B-B	140	12	\$100.50
P-2382T	97	12	\$85.00	P-2408B	140	12	\$104.00
P-2382T-BN	97	12	\$127.50	P-2408B-B	140	12	\$102.00
P-2382T-MB	97	12	\$140.00	P-3210	135	12	\$113.00
P-2383T	99	12	\$65.00	P-3220	135	12	\$110.50
P-2383T-BN	99	12	\$97.50	P-3230	135	6	\$144.00
P-2384T	98	12	\$138.50	P-3230-BN	135	6	\$192.00
P-2384T-6RL	98	12	\$142.70	P-3250	114	6	\$149.00
P-2384T-6RL-BN	98	12	\$199.00	P-3250-BN	114	6	\$198.00
P-2384T-BN	98	12	\$207.75	P-4420	115	12	\$151.00
P-2385T	98	12	\$123.50	P-4420-BN	115	12	\$260.00
P-2385T-6RL	98	12	\$128.00	P-4420-ORB	115	12	\$286.00
P-2385T-6RL-BN	98	12	\$176.50	P-4430	115	12	\$144.00
P-2385T-BN	98	12	\$185.25	P-4430-BN	115	12	\$248.00
P-2386T	98	12	\$106.00	P-4440	115	12	\$162.00
P-2386T-BN	98	12	\$159.00	P-4440-BN	115	12	\$266.00
P-2387T	98	12	\$96.00	P-4430-MZ	115	12	\$287.00
P-2387T-BN	98	12	\$144.00	P-4430-ORB	115	12	\$273.00
P-2390T	101	12	\$100.00	P-4432-E1.5	115	12	\$159.50
P-2390T-BN	101	12	\$150.00	P-4432-E1.5-BN	115	12	\$273.50
P-2391T	101	12	\$90.00	P-4530	95	12	\$144.00
P-2391T-BN	101	12	\$135.00	P-4530-BN	95	12	\$248.00
P-2392T	101	12	\$90.00	X-3300006	100	---	\$12.75
P-2392T-BN	101	12	\$135.00	X-4200111	91	---	\$24.40
P-2393T	102	12	\$68.00	X-4200178	91	---	\$1.50
P-2393T-BN	102	12	\$102.00	X-4200181	91	---	\$39.00
P-2394T	101	12	\$110.00	X-4200189	91	---	\$24.40
P-2394T-6	101	12	\$123.00	X-4300087	100	---	\$16.50
P-2394T-6-BN	101	12	\$184.50	X-4300090	96	---	\$9.00
P-2394T-BN	101	12	\$165.00	X-4900044	96	---	\$2.05
P-2395T	101	12	\$100.00	X-6400088	103	---	\$49.50
P-2395T-6	101	12	\$115.60				

i1 // Lavatory Faucets

NEW FAUCETS

SINGLE HANDLE LAVATORY FAUCETS

	Model#	Description	Finish	Case	Price
	 L-6030	Single Handle Lavatory Faucet Lever Handle	Chrome	12	\$147.00
	L-6030-BN	4-5/8" Reach, 3-1/8" From Deck to Aerator Ceramic Disc Cartridge	PVD Brushed Nickel	12	\$196.00
	L-6030-MB	1-Hole Installation	Matte Black	12	\$235.00
	L-6030B*	50/50 Pop-Up Drain Assembly Easy-Install 18" Flex Supply Lines With 3/8" Connections With 1.2 GPM Flow Rate *Builder Tract Pack	Chrome	12	\$145.00
	L-6030-WD	1 or 3 Hole 4" Installation Deck Cover Plate Included	Chrome	12	\$155.00
	L-6030-WD-BN		PVD Brushed Nickel	12	\$206.15
		 L-6031	Single Handle Lavatory Faucet Lever Handle	Chrome	12
L-6031-BN		4-5/8" Reach, 3-1/8" From Deck to Aerator Ceramic Disc Cartridge 1-Hole Installation Easy-Install 18" Flex Supply Lines With 3/8" Connections With 1.2 GPM Flow Rate	PVD Brushed Nickel	12	\$184.00
L-6031-WD		1 or 3 Hole 4" Installation Deck Cover Plate Included	Chrome	12	\$146.00
L-6031-WD-BN			PVD Brushed Nickel	12	\$197.00
		 L-6032	Single Handle Lavatory Faucet Lever Handle	Chrome	12
	L-6032-BN	4-5/8" Reach, 3-1/8" From Deck to Aerator Ceramic Disc Cartridge	PVD Brushed Nickel	12	\$202.50
	L-6032-MB	1-Hole Installation	Matte Black	12	\$243.00
	L-6032B*	Brass Pop-Up Drain Assembly Easy-Install 18" Flex Supply Lines With 3/8" Connections With 1.2 GPM Flow Rate *Builder Tract Pack	Chrome	12	\$150.00
	L-6032-WD	1 or 3 Hole 4" Installation Deck Cover Plate Included	Chrome	12	\$160.00
	L-6032-WD-BN		PVD Brushed Nickel	12	\$216.00
	L-6033	Push Down Drain With Overflow	Chrome	12	\$157.00









Builder Tract Packs sold in case quantities only.
Low flow aerators available upon request.
See page 3 for special order finish options.

Olympia faucets feature aerators that meet ANSI/ASME A112.18.1 flow requirements of 1.5 GPM

i1 // Pressure Balance Trim Sets

NEW SHOWERS

PRESSURE BALANCE TRIM SETS

		Model#	Description	Finish	Case	Price
		P-2330T	Single Handle Tub/Shower Trim Set Lever Handle	Chrome	6	\$95.00
		P-2330T-BN	Face Plate Single Function 3-3/4" Showerhead, Arm & Flange Combo 1/2" IPS/Slip-On Diverter Tub Spout With Escutcheon With 1.75 GPM Flow Rate For Use with P-2300B & P-2400B Series Valves - Valve not included	PVD Brushed Nickel	6	\$142.50
		P-2331T	Single Handle Tub Trim Set Lever Handle	Chrome	6	\$85.00
		P-2331T-BN	Face Plate Combo 1/2" IPS/Slip-On Diverter Tub Spout With Escutcheon For Use with P-2300B & P-2400B Series Valves - Valve not included	PVD Brushed Nickel	6	\$127.50
		P-2332T	Single Handle Shower Trim Set Lever Handle	Chrome	6	\$85.00
		P-2332T-BN	Face Plate Single Function 3-3/4" Showerhead, Arm & Flange With 1.75 GPM Flow Rate For Use with P-2300B & P-2400B Series Valves - Valve not included	PVD Brushed Nickel	6	\$127.50
		P-2334T	Single Handle Tub/Shower Trim Set Lever Handle	Chrome	6	\$138.50
		P-2334T-BN	Face Plate Single Function Rain Showerhead, Arm & Flange Extended Combo 1/2" IPS/Slip-On Diverter Tub Spout with Escutcheon With 1.75 GPM Flow Rate For Use with P-2300B & P-2400B Series Valves - Valve not included	PVD Brushed Nickel	6	\$207.75
		P-2335T	Single Handle Shower Trim Set Lever Handle	Chrome	6	\$123.50
		P-2335T-BN	Face Plate Single Function Rain Showerhead, Arm & Flange With 1.75 GPM Flow Rate For Use with P-2300B & P-2400B Series Valves - Valve not included	PVD Brushed Nickel	6	\$185.25
		P-2333T	Single Handle Valve Trim Set Lever Handle	Chrome	6	\$65.00
		P-2333T-BN	Face Plate For Use with P-2300B & P-2400B Series Valves - Valve not included	PVD Brushed Nickel	6	\$97.50
		P-2230T	Single Handle Diverter Set Lever Handle	Chrome	6	\$78.00
		P-2230T-BN	Diverter Valve Face Plate Diverter Valve Sleeve For Use with 4100B Valve - Valve not included	PVD Brushed Nickel	6	\$87.00



OLYMPIA i1

See page 3 for special order finish options.

Olympia showerheads meet ANSI/ASME A112.18.1 flow requirements of maximum 1.75 GPM

i2 // Single Handle Kitchen Faucets

SINGLE HANDLE PULL-DOWN KITCHEN FAUCETS

	Model#	Description	Finish	Case	Price
	K-5020	Single Handle Pull-Down Kitchen Faucet Lever Handle	Chrome	6	\$225.00
	K-5020-BN	Pull-Down Head with 2 Spray Patterns Swivel 360° 7-5/8" Reach, 8-5/8" From Deck to Aerator	PVD Brushed Nickel	6	\$282.50
	K-5020B*	Ceramic Disc Cartridge 1 or 3-Hole 8" Installation Ball Joint Swivel Spray Head Easy-Install 30" Flex Supply Lines With 3/8" Connections Quick Connect Spray Head Hose and Weight, Easy-install mounting nut With 1.8 GPM Flow Rate Deck Cover Plate Included *Builder Tract Pack	Chrome	6	\$223.00
	K-5020-E1.5	With 1.5 GPM Flow Rate	PVD Brushed Nickel	6	\$228.00
	K-5020-E1.5-BN		Chrome	6	\$285.50
	K-5025	Single Handle Pull-Down Kitchen Faucet Lever Handle	Chrome	6	\$238.00
	K-5025-BN	Pull-Down Head with 2 Spray Patterns Swivel 360° 7-5/8" Reach, 8-3/4" From Deck to Aerator	PVD Brushed Nickel	6	\$299.00
	K-5025-MB	Ceramic Disc Cartridge 1 or 3-Hole 8" Installation Ball Joint Swivel Spray Head Easy-Install 30" Flex Supply Lines With 3/8" Connections With 1.8 GPM Flow Rate Deck Cover Plate Included	Matte Black	6	\$314.00
PARTS	OP-120004	Lever Handle	Chrome	---	\$15.00
	OP-390003	Ceramic Disc Cartridge	---	---	\$13.00
	OP-420045	Deck Plate	Chrome	---	\$12.60
	OP-420054	Pull Down Spray Head	Chrome	---	\$24.00
	OP-420055	Spray Hose and O-ring	---	---	\$10.00
	OP-420056	Spout Repair Kit	---	---	\$0.90
	OP-420057	Locknut	---	---	\$3.20
	OP-420058	Cap	Chrome	---	\$6.40
	OP-420059	Washer	---	---	\$0.70
	OP-420060	O-Ring	---	---	\$0.50
	OP-420061	Allen Screw	---	---	\$0.70
	OP-420062	Weight	---	---	\$10.00
	OP-520003	Mounting Kit	---	---	\$2.50
	OP-520005	Mounting Kit	---	---	\$4.20
	OP-520012	Mounting Tool	---	---	\$5.00





Low flow spray head available upon request for the K-5020. See page 3 for special order finish options.

Olympia faucets feature aerators that meet ANSI/ASME A112.18.1 flow requirements of 1.8 GPM

i2 // Single Handle Kitchen Faucets

NEW FAUCETS

SINGLE HANDLE PULL-DOWN PRE-RINSE KITCHEN FAUCETS

	Model#	Description	Finish	Case	Price
	 K-5010	Single Handle Pre-Rinse Spring Pull-Down Kitchen Faucet	Chrome	6	\$243.00
	K-5010-BN	Lever Handle	PVD Brushed Nickel	6	\$310.00
	K-5010-MB	Pull-Down with 2 Spray Pattern Swivel 360° 7-5/8" Reach, 7-1/4" from Deck to Aerator, 21-1/4" Overall Height Ceramic Disc Cartridge 1 or 3-Hole 8" Installation Spring Style Spout Swivels 360° Easy-Install 30" Flex Supply Lines With 3/8" Connections With 1.8 GPM Flow Rate Quick Connect Spray Head Hose and Weight, Easy-install mounting nut Deck Cover Plate Included	Matte Black	6	\$325.50
			K-5010-E1.5	With 1.5 GPM Flow Rate	Chrome
	K-5010-E1.5-BN		PVD Brushed Nickel	6	\$313.00
	 K-5015	Single Handle Pre-Rinse Spring Pull-Down Kitchen Faucet	Chrome	6	\$256.00
	K-5015-BN	Lever Handle Pull-Down with 2 Spray Pattern Swivel 360° 7-5/8" Reach, 7" from Deck to Aerator, 21-1/4" Overall Height Ceramic Disc Cartridge 1 or 3-Hole 8" Installation Spring Style Spout Swivels 360° Easy-Install 30" Flex Supply Lines With 3/8" Connections With 1.8 GPM Flow Rate Quick Connect Spray Head Hose and Weight, Easy-install mounting nut Deck Cover Plate Included	PVD Brushed Nickel	6	\$326.50
PARTS	OP-420067	Pull-Down Spray Head-1.8 GPM	Chrome	---	\$24.00
	X-4200189	Spray Head Flex Hose	---	---	\$24.40
	OP-420069	Spring	Chrome	---	\$49.00
	OP-420056	Spout Repair Kit	---	---	\$0.90
	OP-390003	Ceramic Cartridge	---	---	\$13.00
	OP-420057	Retainer Nut	---	---	\$3.20
	OP-420058	Cap	Chrome	---	\$6.40
	OP-120004	Lever Handle	Chrome	---	\$15.00
	OP-420059	Washer	---	---	\$0.70
	OP-520015	Locknut With Two Screws	---	---	\$4.98
	OP-420070	Hose Weight	---	---	\$10.00
	OP-420045	Deck Plate	Chrome	---	\$12.60
	OP-520003	Mounting Hardware	---	---	\$3.00
	OP-420061	Handle 3/32" Allen Screw	---	---	\$0.70
	X-4200181	Pull-Down Spray Head-1.8 GPM	Chrome	---	\$39.00
	X-4200111	Spray Head Flex Hose	---	---	\$24.40
	X-4200178	Hose Support	---	---	\$1.50



Low flow spray head available upon request for the K-5010. See page 3 for special order finish options.

Olympia faucets feature aerators that meet ANSI/ASME A112.18.1 flow requirements of 1.8 GPM

OLYMPIA 12

i2 // Lavatory Faucets

SINGLE HANDLE LAVATORY FAUCETS

	Model#	Description	Finish	Case	Price
	L-6050	Single Handle Lavatory Faucet Lever Handle	Chrome	12	\$147.00
	L-6050-BN	4-3/4" Reach, 2-1/2" From Deck to Aerator Ceramic Disc Cartridge	PVD Brushed Nickel	12	\$196.00
	L-6050-MB	1-Hole Installation	Matte Black	12	\$211.00
	L-6050B*	50/50 Pop-Up Drain Assembly Easy-Install 18" Flex Supply Lines With 3/8" Connections	Chrome	12	\$145.00
	L-6050B-BN*	With 1.2 GPM Flow Rate *Builder Tract Pack	PVD Brushed Nickel	12	\$194.00
	L-6050B-E0.5	With 0.5 GPM Flow Rate	Chrome	12	\$149.00
	L-6050B-E1.0	With 1.0 GPM Flow Rate	Chrome	12	\$149.00
	L-6050-WD	1 or 3 Hole 4" Installation Deck Cover Plate Included	Chrome	12	\$155.00
	L-6050-WD-BN		PVD Brushed Nickel	12	\$206.15
	L-6051	Single Handle Lavatory Faucet Lever Handle	Chrome	12	\$136.00
	L-6051-BN	4-3/4" Reach, 2-1/2" From Deck to Aerator Ceramic Disc Cartridge 1-Hole Installation Easy-Install 18" Flex Supply Lines With 3/8" Connections With 1.2 GPM Flow Rate	PVD Brushed Nickel	12	\$184.00
	L-6051-E0.5	With 0.5 GPM Flow Rate	Chrome	12	\$139.00
	L-6051-E0.5-BN		PVD Brushed Nickel	12	\$187.00
	L-6051-E1.0	With 1.0 GPM Flow Rate	Chrome	12	\$139.00
	L-6051-E1.0-BN		PVD Brushed Nickel	12	\$187.00
	L-6051-WD	1 or 3 Hole 4" Installation Deck Cover Plate Included	Chrome	12	\$146.00
	L-6051-WD-BN		PVD Brushed Nickel	12	\$197.00
	L-6051G	Single Handle Lavatory Faucet Lever Handle	Chrome	12	\$151.00
	L-6051G-BN	4-3/4" Reach, 2-1/2" From Deck to Aerator Ceramic Disc Cartridge 1-Hole Installation Brass Grid Strainer Drain Assembly Easy-Install 18" Flex Supply Lines With 3/8" Connections With 1.2 GPM Flow Rate	PVD Brushed Nickel	12	\$204.00
	L-6051G-E1.0	With 1.0 GPM Flow Rate	Chrome	12	\$154.00
	L-6051G-WD	1 or 3 Hole 4" Installation Deck Cover Plate Included	Chrome	12	\$159.00
	L-6051G-WD-BN		PVD Brushed Nickel	12	\$211.50

Builder Tract Packs sold in case quantities only.
Low flow aerators available upon request.
See page 3 for special order finish options.

Olympia faucets feature aerators that meet ANSI/ASME A112.18.1 flow requirements of 1.5 GPM

i2 // Lavatory Faucets

SINGLE HANDLE LAVATORY FAUCETS

	Model#	Description	Finish	Case	Price
	L-6052	Single Handle Lavatory Faucet Lever Handle	Chrome	12	\$152.00
	L-6052-BN	4-3/4" Reach, 2-1/2" From Deck to Aerator Ceramic Disc Cartridge	PVD Brushed Nickel	12	\$202.50
	L-6052B*	1-Hole Installation	Chrome	12	\$150.00
	L-6052B-BN*	Brass Pop-Up Drain Assembly Easy-Install 18" Flex Supply Lines With 3/8" Connections With 1.2 GPM Flow Rate *Builder Tract Pack	PVD Brushed Nickel	12	\$200.50
	L-6052-E1.0	With 1.0 GPM Flow Rate	PVD Brushed Nickel	12	\$155.00
	L-6052-E1.0-BN		Chrome	12	\$205.50
	L-6052-WD	1 or 3 Hole 4" Installation Deck Cover Plate Included	Chrome	12	\$160.00
	L-6052-WD-BN		PVD Brushed Nickel	12	\$216.00
	L-6053	Push Down Drain With Overflow	Chrome	12	\$157.00
	PARTS	OP-130001	Lever Handle	Chrome	---
OP-430021		Cap	Chrome	---	\$6.40
OP-430022		Retainer Nut	---	---	\$3.20
OP-390003		Ceramic Disc Cartridge	---	---	\$13.00
OP-430024		Aerator	Chrome	---	\$5.70
OP-430025		Washer	---	---	\$0.70
OP-530005		Mounting Kit	---	---	\$5.00
OP-630005		50/50 Pop-Up Drain Assembly	Chrome	---	\$26.00
OP-490029		3/32" Allen Screw	---	---	\$0.70
OP-430023		Hole Cover	Chrome	---	\$1.00
OP-630001		Grid Strainer Drain	Chrome	---	\$27.60
OP-630006		Brass Pop-Up Drain Assembly	Chrome	---	\$29.00









Builder Tract Packs sold in case quantities only.
Low flow aerators available upon request.
See page 3 for special order finish options.

Olympia faucets feature aerators that meet ANSI/ASME A112.18.1 flow requirements of 1.5 GPM

i2 // Pressure Balance Trim Sets

NEW SHOWERS

PRESSURE BALANCE TRIM SETS

	Model#	Description	Finish	Case	Price
	 P-2370T	Single Handle Tub/Shower Trim Set Lever Handle	Chrome	12	\$95.00
	P-2370T-BN	Face Plate	PVD Brushed Nickel	12	\$142.50
	P-2370T-MB	Single Function 3-3/4" Showerhead, Arm & Flange Combo 1/2" IPS/Slip-On Diverter Tub Spout With Escutcheon With 1.75 GPM Flow Rate For Use with P-2300B & P-2400B Series Valves - Valve not included	Matte Black	12	\$156.00
	P-2371T	Single Handle Tub Trim Set Lever Handle	Chrome	12	\$85.00
	P-2371T-BN	Face Plate Combo 1/2" IPS/Slip-On Tub Spout With Escutcheon For Use with P-2300B & P-2400B Series Valves - Valve not included	PVD Brushed Nickel	12	\$127.50
	P-2372T	Single Handle Shower Trim Set Lever Handle	Chrome	12	\$85.00
	P-2372T-BN	Face Plate	PVD Brushed Nickel	12	\$127.50
	P-2372T-MB	Single Function 3-3/4" Showerhead, Arm & Flange With 1.75 GPM Flow Rate For Use with P-2300B & P-2400B Series Valves - Valve not included	Matte Black	12	\$140.00
		 P-2374T	Single Handle Tub/Shower Trim Set Lever Handle	Chrome	12
P-2374T-BN		Face Plate Single Function Rain Showerhead, Arm & Flange Extended Combo 1/2" IPS/Slip-On Diverter Tub Spout with Escutcheon With 1.75 GPM Flow Rate For Use with P-2300B & P-2400B Series Valves - Valve not included	PVD Brushed Nickel	12	\$207.75
P-2374T-6S		Single Function 6" Square Showerhead, Arm & Flange	Chrome	12	\$144.00
P-2375T		Single Handle Shower Trim Set Lever Handle	Chrome	12	\$123.50
P-2375T-BN		Face Plate Single Function Rain Showerhead, Arm & Flange With 1.75 GPM Flow Rate For Use with P-2300B & P-2400B Series Valves - Valve not included	PVD Brushed Nickel	12	\$185.25
P-2375T-6S		Single Function 6" Square Showerhead, Arm & Flange	Chrome	12	\$129.00
		 P-2373T	Single Handle Valve Trim Set Lever Handle	Chrome	12
	P-2373T-BN	Face Plate For Use with P-2300B & P-2400B Series Valves - Valve not included	PVD Brushed Nickel	12	\$97.50
	 P-2270T	Single Handle Diverter Set Lever Handle	Chrome	12	\$78.00
	P-2270T-BN	Diverter Valve Face Plate Diverter Valve Sleeve For Use with 4100B Valve - Valve not included	PVD Brushed Nickel	12	\$87.00

See page 3 for special order finish options.

i2 // Pressure Balance Trim Sets

NEW SHOWERS

PRESSURE BALANCE TRIM SETS

	Model#	Description	Finish	Case	Price
PARTS	OP-140011	Lever Handle (For P-2370T Series)	Chrome	---	\$22.00
	OP-160003	Lever Handle (For P-2270)	Chrome	---	\$21.00
	OP-440010	Face Plate Screw	Chrome	---	\$3.00
	OP-440051	Face Plate	Chrome	---	\$21.00
	OP-490011	3/32" Allen Wrench	---	---	\$0.70
	OP-640001	Shower Arm Flange	Chrome	---	\$1.20
	OP-640002	Shower Arm	Chrome	---	\$11.00
	OP-640007	Diverter Tub Spout	Chrome	---	\$20.50
	OP-640008	Escutcheon	Chrome	---	\$9.00
	OP-640019	Non Diverter Tub Spout	Chrome	---	\$13.30
	OP-640038	Single Function Showerhead-1.75 GPM	Chrome	---	\$30.00
	OP-640039	Single Function Showerhead-1.5 GPM	Chrome	---	\$31.00
	OP-640040	Extended 7" Diverter Tub Spout	Chrome	---	\$55.00
	OP-640037	1.75 GPM Rain Shower Head (For P-2374T, P-2375T)	Chrome	---	\$53.00
	OP-440054	Sleeve	Chrome	---	\$6.00

HANDHELD SHOWER SETS



	Model#	Description	Finish	Case	Price
	P-4530	Handheld Shower Set	Chrome	12	\$144.00
	P-4530-BN	Three Functions Handheld Showerhead W/Non-Positive Shut Off 24" Slide Bar with Mounts 60" Stainless Steel Flex Hose Brass Drop Ell with Vacuum Breaker With 1.75 GPM Flow Rate Valve Sold Separately	PVD Brushed Nickel	12	\$248.00
PARTS	OP-660007	Handheld Showerhead	Chrome	---	\$43.00
	OP-460027	SST Hose	---	---	\$22.00
	OP-460020	Vacuum Breaker	Chrome	---	\$12.30
	OP-460006	Drop Ell	Chrome	---	\$32.70
	OP-460026	Slide Bar and Hose Support	Chrome	---	\$83.00
	OP-460011	Mounting Screw	---	---	\$1.10

See page 3 for special order finish options.

Olympia showerheads meet ANSI/ASME A112.18.1 flow requirements of maximum 1.75 GPM

i2v // Single Handle Faucets

SINGLE HANDLE LAVATORY FAUCETS

	Model#	Description	Finish	Case	Price
	L-6020	Single Handle Lavatory Faucet Lever Handle	Chrome	12	\$155.00
	L-6020-BN	3-5/8" Reach, 3" From Deck to Aerator Ceramic Disc Cartridge	PVD Brushed Nickel	12	\$206.15
	L-6020-MB	1-Hole Installation	Matte Black	12	\$217.00
	L-6020B*	50/50 Pop-Up Drain Assembly Easy-Install 18" Flex Supply Lines With 3/8" Connections With 1.2 GPM Flow Rate	Chrome	12	\$153.00
	L-6020-WD	1 or 3 Hole 4" Installation Deck Cover Plate Included	Chrome	12	\$163.00
	L-6020-WD-BN		PVD Brushed Nickel	12	\$216.80
	L-6021	Single Handle Lavatory Faucet Lever Handle	Chrome	12	\$137.00
	L-6021-BN	3-5/8" Reach, 3" From Deck to Aerator Ceramic Disc Cartridge 1-Hole Installation With Pop-up Hole Cover	PVD Brushed Nickel	12	\$182.25
	L-6021-WD	1 or 3 Hole 4" Installation Deck Cover Plate Included	Chrome	12	\$145.00
	L-6021-WD-BN		PVD Brushed Nickel	12	\$192.85
	L-6022	Single Handle Lavatory Faucet Lever Handle	Chrome	12	\$160.00
	L-6022-BN	3-5/8" Reach, 3" From Deck to Aerator Ceramic Disc Cartridge	PVD Brushed Nickel	12	\$212.80
	L-6022B*	1-Hole Installation	Chrome	12	\$158.00
	L-6023**	Brass Pop-Up Drain Assembly Easy-Install 18" Flex Supply Lines With 3/8" Connections With 1.2 GPM Flow Rate	Chrome	12	\$165.00
	L-6022-WD	1 or 3 Hole 4" Installation Deck Cover Plate Included	Chrome	12	\$168.00
	L-6022-WD-BN		PVD Brushed Nickel	12	\$223.50
PARTS	OP-130003	Lever Handle	Chrome	---	\$16.00
	OP-430021	Cap	Chrome	---	\$6.40
	OP-420042	Locknut	---	---	\$3.20
	OP-320002	Ceramic Disc Cartridge	---	---	\$14.80
	OP-430023	Hole Cover(For L-6021, L-6021-WD, L-6023)	Chrome	---	\$1.00
	X-4300090	1.5 GPM Laminar	---	---	\$9.00
	OP-430025	Gasket	---	---	\$0.70
	OP-430026	Deck Plate (For L-6020-WD, L-6021-WD, L-6022-WD)	Chrome	---	\$16.75
	OP-530005	Mounting Kit	---	---	\$5.00
	OP-630005	50/50 Pop-Up Drain Assembly (For L-6020, L-6020-WD)	Chrome	---	\$26.00
	OP-630006	Brass Pop-Up Drain Assembly (For L-6022, L-6022-WD)	Chrome	---	\$29.00
	OP-630007	Touch Down Drain (For L-6023)	Chrome	---	\$34.00
	OP-420061	3/32" Allen Screw	---	---	\$0.70
	X-4900044	Hole Cover	Chrome	---	\$2.05



Builder Tract Packs sold in case quantities only.
Low flow aerators available upon request.
See page 3 for special order finish options.

Olympia faucets feature aerators that meet ANSI/ASME A112.18.1 flow requirements of 1.2 GPM

i2v // Two Handle Lavatory/Pressure Balance Trim Sets

NEW FAUCETS

WIDESPREAD LAVATORY FAUCETS

	Model#	Description	Finish	Case	Price
	L-7420	Two Handle Lavatory Widespread Faucet Lever Handles	Chrome	6	\$205.00
	L-7420-BN	Rigid Gooseneck Spout 4" Reach, 5" From Deck to Aerator Ceramic Disc Cartridges 3-Hole 4" to 16" Installation 50/50 Pop-Up Drain Assembly With 1.2 GPM Flow Rate	PVD Brushed Nickel	6	\$240.00
	L-7422	Two Handle Lavatory Widespread Faucet Lever Handles	Chrome	6	\$210.00
	L-7422-BN	Rigid Gooseneck Spout 4" Reach, 5" From Deck to Aerator Ceramic Disc Cartridges 3-Hole 4" to 16" Installation 50/50 Pop-Up Drain Assembly With 1.2 GPM Flow Rate	PVD Brushed Nickel	6	\$245.00
	L-7422-MB		Matte Black	6	\$258.00
PARTS	OP-490011	3/32" Allen Wrench	---	---	\$0.70
	OP-190016C	Lever Handle-Cold	Chrome	---	\$17.55
	OP-190016H	Lever Handle-Hot	Chrome	---	\$17.55
	OP-430036	Valve Escutcheon	Chrome	---	\$11.50
	OP-490006	Bonnet Nut	---	---	\$5.30
	OP-330002C	Ceramic Stem-Cold	---	---	\$8.00
	OP-330002H	Ceramic Stem-Hot	---	---	\$8.00
	OP-590002	Valve Mounting Hardware	---	---	\$5.90
	OP-490009	Y Connector Set	---	---	\$20.40
	OP-430001	Spout Mounting Hardware	---	---	\$3.50
	OP-230006	Gooseneck Spout Set	Chrome	---	\$99.00
	OP-630008	50/50 Pop-Up Drain Assembly	Chrome	---	\$35.00
	OP-630009	Brass Pop-Up Drain Assembly	Chrome	---	\$40.00
	OP-420047	Allen Screw	---	---	\$0.70
	OP-490062	Male 13/16" Thread Aerator And Aerator Tool-1.2 GPM	Chrome	---	\$6.70
	OP-430037	Spout Escutcheon	Chrome	---	\$11.50

PRESSURE BALANCE TRIM SETS

	Model#	Description	Finish	Case	Price
	P-2380T	Single Handle Tub/Shower Trim Set Lever Handle - Face Plate	Chrome	12	\$95.00
	P-2380T-BN	Single Function 3-3/4" Showerhead, Arm & Flange	PVD Brushed Nickel	12	\$142.50
	P-2380T-MB	Combo 1/2" IPS/Slip-On Diverter Tub Spout With Escutcheon With 1.75 GPM Flow Rate For Use with P-2300B & P-2400B Series Valves - Valve not included	Matte Black	12	\$156.00
	P-2381T	Single Handle Tub Trim Set Lever Handle - Face Plate	Chrome	12	\$85.00
	P-2381T-BN	Combo 1/2" IPS/Slip-On Tub Spout With Escutcheon For Use with P-2300B & P-2400B Series Valves - Valve not included	PVD Brushed Nickel	12	\$127.50
	P-2382T	Single Handle Shower Trim Set Lever Handle - Face Plate	Chrome	12	\$85.00
	P-2382T-BN	Single Function 3-3/4" Showerhead, Arm & Flange With 1.75 GPM Flow Rate	PVD Brushed Nickel	12	\$127.50
	P-2382T-MB	For Use with P-2300B & P-2400B Series Valves - Valve not included	Matte Black	12	\$140.00



See page 3 for special order finish options.

Olympia showerheads meet ANSI/ASME A112.18.1 flow requirements of maximum 1.75 GPM

i2v // Pressure Balance Trim Sets

NEW SHOWERS

PRESSURE BALANCE TRIM SETS

	Model#	Description	Finish	Case	Price	
	P-2384T	Single Handle Tub/Shower Trim Set Lever Handle	Chrome	12	\$138.50	
	P-2384T-BN	Face Plate Single Function Rain Showerhead, Arm & Flange Extended Combo 1/2" IPS/Slip-On Diverter Tub Spout with Escutcheon With 1.75 GPM Flow Rate For Use with P-2300B & P-2400B Series Valves - Valve not included	PVD Brushed Nickel	12	\$207.75	
	P-2385T	Single Handle Shower Trim Set Lever Handle	Chrome	12	\$123.50	
	P-2385T-BN	Face Plate Single Function Rain Showerhead, Arm & Flange With 1.75 GPM Flow Rate For Use with P-2300B & P-2400B Series Valves - Valve not included	PVD Brushed Nickel	12	\$185.25	
		P-2384T-6RL	Single Handle Tub/Shower Trim Set Lever Handle, Face Plate	Chrome	12	\$142.70
		P-2384T-6RL-BN	Single Function Rain Showerhead, 15" L Shape Shower Arm & Flange Extended Combo 1/2" IPS/Slip-On Diverter Tub Spout with Escutcheon With 1.75 GPM Flow Rate For Use with P-2300B & P-2400B Series Valves - Valve not included	PVD Brushed Nickel	12	\$199.00
P-2385T-6RL		Single Handle Tub/Shower Trim Set Lever Handle, Face Plate	Chrome	12	\$128.00	
P-2385T-6RL-BN		Single Function Rain Showerhead, 15" L Shape Shower Arm & Flange With 1.75 GPM Flow Rate For Use with P-2300B & P-2400B Series Valves - Valve not included	PVD Brushed Nickel	12	\$176.50	
	P-2386T	Single Handle Tub/Shower Trim Set Lever Handle	Chrome	12	\$106.00	
	P-2386T-BN	Face Plate Three Function 4-5/8" Showerhead, Arm & Flange Combo 1/2" IPS/Slip-On Diverter Tub Spout With Escutcheon With 1.75 GPM Flow Rate For Use with P-2300B & P-2400B Series Valves - Valve not included	PVD Brushed Nickel	12	\$159.00	
	P-2387T	Single Handle Shower Trim Set Lever Handle	Chrome	12	\$96.00	
	P-2387T-BN	Face Plate Three Function 4-5/8" Showerhead, Arm & Flange With 1.75 GPM Flow Rate For Use with P-2300B & P-2400B Series Valves - Valve not included	PVD Brushed Nickel	12	\$144.00	







See page 3 for special order finish options.

Olympia showerheads meet ANSI/ASME A112.18.1 flow requirements of maximum 1.75 GPM

i2v // Pressure Balance & Roman Tub Trim Sets

NEW SHOWERS

PRESSURE BALANCE & ROMAN TUB TRIM SETS

		Model#	Description	Finish	Case	Price
		P-2383T	Single Handle Valve Trim Set Lever Handle	Chrome	12	\$65.00
		P-2383T-BN	Face Plate For Use with P-2300B & P-2400B Series Valves - Valve not included	PVD Brushed Nickel	12	\$97.50
		P-2280T	Single Handle Diverter Trim Set Lever Handle	Chrome	12	\$78.00
		P-2280T-BN	Diverter Valve Face Plate Diverter Valve Sleeve For Use with 4100B Valve - Valve not included	PVD Brushed Nickel	12	\$87.00
PARTS		OP-640001	Shower Arm Flange	Chrome	---	\$1.20
		OP-640002	Shower Arm	Chrome	---	\$11.00
		OP-640038	1.75 GPM Shower Head	Chrome	---	\$30.00
		OP-640037	1.75 GPM Rain Shower Head (For P-2384T, P-2385T)	Chrome	---	\$53.00
		OP-640041	1.75 GPM Shower Head (For P-2386T, P-2387T)	Chrome	---	\$49.00
		OP-440051	Face Plate	Chrome	---	\$21.00
		OP-140018	Lever Handle	Chrome	---	\$24.00
		OP-490011	3/32" Allen Wrench	---	---	\$0.70
		OP-640007	Diverter Tub Spout (For P-2370T, P-2380T, P-2386T)	Chrome	---	\$20.50
		OP-640008	Spout Escutcheon (For P-2370T, P-2371T, P-2380T, P-2381T, P-2384T, P-2386T)	Chrome	---	\$9.00
		OP-640019	Tub Spout (For P-2371T, P-2381T)	Chrome	---	\$13.30
		OP-640040	7" Extended Diverter Tub Spout (For P-2384T)	Chrome	---	\$55.00
		OP-440054	Sleeve	Chrome	---	\$6.00
		OP-440043	Allen Screw	---	---	\$1.00
		OP-440010	Face Plate Screws	---	---	\$3.00
		P-1171T	Two Handle Roman Tub Trim Set Lever Handles	Chrome	6	\$165.00
		P-1171T-BN	Gooseneck Rigid Spout 8" Reach 3-Hole 8" to 16" Installation Trim Only, P-1131B Valve Required	PVD Brushed Nickel	6	\$198.00













See page 3 for special order finish options.

Olympia showerheads meet ANSI/ASME A112.18.1 flow requirements of maximum 1.75 GPM

OLYMPIA i2v

i3 // Single Handle Lavatory Faucets

SINGLE HANDLE LAVATORY FAUCETS











		Model#	Description	Finish	Case	Price
	  	L-6010	Single Handle Lavatory Faucet Lever Handle	Chrome	12	\$165.00
		L-6010-BN	4-3/8" Reach, 2-5/8" From Deck to Aerator Ceramic Disc Cartridge	PVD Brushed Nickel	12	\$219.45
		L-6010-MB	1-Hole Installation	Matte Black	12	\$325.50
		L-6010B*	50/50 Pop-Up Drain Assembly Easy-Install 18" Flex Supply Lines With 3/8" Connections With 1.2 GPM Flow Rate *Builder Tract Pack	Chrome	12	\$163.00
		L-6010-WD	1 or 3 Hole 4" Installation Deck Cover Plate Included	Chrome	12	\$175.00
		L-6010-WD-BN		PVD Brushed Nickel	12	\$233.00
	  	L-6011	Single Handle Lavatory Faucet Lever Handle	Chrome	12	\$147.00
		L-6011-BN	4-3/8" Reach, 2-5/8" From Deck to Aerator Ceramic Disc Cartridge 1-Hole Installation No Pop-up Hole Easy-Install 18" Flex Supply Lines With 3/8" Connections With 1.2 GPM Flow Rate	PVD Brushed Nickel	12	\$195.60
		L-6011-WD	1 or 3 Hole 4" Installation Deck Cover Plate Included	Chrome	12	\$157.00
		L-6011-WD-BN		PVD Brushed Nickel	12	\$209.00
	  	L-6012	Single Handle Lavatory Faucet Lever Handle	Chrome	12	\$170.00
		L-6012-BN	4-3/8" Reach, 2-5/8" From Deck to Aerator Ceramic Disc Cartridge	PVD Brushed Nickel	12	\$226.10
		L-6012B*	1-Hole Installation	Chrome	12	\$168.00
		L-6013**	Brass Pop-Up Drain Assembly Easy-Install 18" Flex Supply Lines With 3/8" Connections With 1.2 GPM Flow Rate * Builder Tract Pack ** With Push Down Brass Drain	Chrome	12	\$175.00
		L-6012-WD	1 or 3 Hole 4" Installation Deck Cover Plate Included	Chrome	12	\$180.00
		L-6012-WD-BN		PVD Brushed Nickel	12	\$240.00
PARTS		OP-130002	Lever Handle	Chrome	---	\$18.00
		OP-430021	Cap	Chrome	---	\$6.40
		OP-430032	Locknut	---	---	\$7.00
		X-3300006	Ceramic Disc Cartridge	---	---	\$12.75
		X-4300090	1.5 GPM Laminar	---	---	\$9.00
		OP-430033	Gasket	---	---	\$1.00
		X-4300087	Deck Plate (For L-6010-WD, L-6011-WD, L-6012-WD)	Chrome	---	\$16.50
		OP-530005	Mounting Kit	---	---	\$5.00
		OP-630005	50/50 Pop-Up Drain Assembly (For L-6010, L-6010-WD)	Chrome	---	\$26.00
		OP-630006	Brass Pop-Up Drain Assembly (For L-6012, L-6012-WD)	Chrome	---	\$29.00
		OP-630007	Touch Down Drain (For L-6013)	Chrome	---	\$34.00
		OP-420047	3/32" Allen Screw	---	---	\$0.70
		X-4900044	Hole Cover	Chrome	---	\$2.05

Builder Tract Packs sold in case quantities only.
Low flow aerators available upon request.
See page 3 for special order finish options.

Olympia faucets feature aerators that meet ANSI/ASME A112.18.1 flow requirements of 1.5 GPM

i3 // Pressure Balance Trim Sets

PRESSURE BALANCE TRIM SETS





	Model#	Description	Finish	Case	Price
	  	P-2390T Single Handle Tub/Shower Trim Set Lever Handle	Chrome	12	\$100.00
		P-2390T-BN Face Plate Single Function 3-3/4" Showerhead, Arm & Flange Combo 1/2" IPS/Slip-On Diverter Tub Spout With Escutcheon With 1.75 GPM Flow Rate For Use with P-2300B & P-2400B Series Valves - Valve not included	PVD Brushed Nickel	12	\$150.00
		P-2391T Single Handle Tub Trim Set Lever Handle	Chrome	12	\$90.00
		P-2391T-BN Face Plate Combo 1/2" IPS/Slip-On Tub Spout With Escutcheon For Use with P-2300B & P-2400B Series Valves - Valve not included	PVD Brushed Nickel	12	\$135.00
		P-2392T Single Handle Shower Trim Set Lever Handle	Chrome	12	\$90.00
		P-2392T-BN Face Plate Single Function 3-3/4" Showerhead, Arm & Flange With 1.75 GPM Flow Rate For Use with P-2300B & P-2400B Series Valves - Valve not included	PVD Brushed Nickel	12	\$135.00
	  	P-2394T Single Handle Tub/Shower Trim Set Lever Handle	Chrome	12	\$110.00
		P-2394T-BN Face Plate Single Function 4" Square Showerhead, Arm & Flange Combo 1/2" IPS/Slip-On Diverter Tub Spout with Escutcheon With 1.75 GPM Flow Rate For Use with P-2300B & P-2400B Series Valves - Valve not included	PVD Brushed Nickel	12	\$165.00
		P-2395T Single Handle Shower Trim Set Lever Handle	Chrome	12	\$100.00
		P-2395T-BN Face Plate Single Function 4" Square Showerhead, Arm & Flange With 1.75 GPM Flow Rate For Use with P-2300B & P-2400B Series Valves - Valve not included	PVD Brushed Nickel	12	\$150.00
		P-2394T-6 Single Handle Tub/Shower Trim Set Lever Handle	Chrome	12	\$123.00
		P-2394T-6-BN Face Plate Single Function 6" Square Showerhead, Arm & Flange Combo 1/2" IPS/Slip-On Diverter Tub Spout with Escutcheon With 1.75 GPM Flow Rate For Use with P-2300B & P-2400B Series Valves - Valve not included	PVD Brushed Nickel	12	\$184.50
	 	P-2395T-6 Single Handle Shower Trim Set Lever Handle	Chrome	12	\$115.60
		P-2395T-6-BN Face Plate Single Function 6" Square Showerhead, Arm & Flange With 1.75 GPM Flow Rate For Use with P-2300B & P-2400B Series Valves - Valve not included	PVD Brushed Nickel	12	\$173.40

See page 3 for special order finish options.

Olympia showerheads meet ANSI/ASME A112.18.1 flow requirements of maximum 1.75 GPM

i3 // Pressure Balance Trim Sets

PRESSURE BALANCE TRIM SETS

	Model#	Description	Finish	Case	Price
	P-2396T	Single Handle Tub/Shower Trim Set Lever Handle	Chrome	12	\$140.00
	P-2396T-BN	Face Plate Single Function 3-3/4" Showerhead, Arm & Flange Extended Combo 1/2" IPS/Slip-On Diverter Tub Spout With Escutcheon With 1.75 GPM Flow Rate For Use with P-2300B & P-2400B Series Valves - Valve not included	PVD Brushed Nickel	12	\$210.00
	P-2397T	Single Handle Tub Trim Set Lever Handle	Chrome	12	\$120.00
	P-2397T-BN	Face Plate Extended Combo 1/2" IPS/Slip-On Tub Spout With Escutcheon For Use with P-2300B & P-2400B Series Valves - Valve not included	PVD Brushed Nickel	12	\$180.00
	P-2398T	Single Handle Tub/Shower Trim Set Lever Handle	Chrome	12	\$155.00
	P-2398T-BN	Face Plate	Matte Black	12	\$256.00
	P-2398T-MB	Single Function 4" Square Showerhead, Arm & Flange Extended Combo 1/2" IPS/Slip-On Diverter Tub Spout With Escutcheon With 1.75 GPM Flow Rate	PVD Brushed Nickel	12	\$232.50
	P-2398T-6*		Chrome	12	\$168.00
	P-2398T-6-BN*	For Use with P-2300B & P-2400B Series Valves - Valve not included * With Single Function 6" Square Showerhead	PVD Brushed Nickel	12	\$252.00
	P-2393T	Single Handle Valve Trim Set Lever Handle	Chrome	12	\$68.00
	P-2393T-BN	Face Plate For Use with P-2300B & P-2400B Series Valves - Valve not included	PVD Brushed Nickel	12	\$102.00
	P-2290T	Single Handle Diverter Trim Set Lever Handle	Chrome	12	\$78.00
	P-2290T-BN	Diverter Valve Face Plate Diverter Valve Sleeve For Use with 4100B Valve - Valve not included	PVD Brushed Nickel	12	\$87.00

See page 3 for special order finish options.

Olympia showerheads meet ANSI/ASME A112.18.1 flow requirements of maximum 1.75 GPM



i3 // Pressure Balance Trim Sets

PRESSURE BALANCE TRIM SETS

	Model#	Description	Finish	Case	Price
PARTS	OP-640045	Shower Arm Flange	Chrome	---	\$8.00
	OP-640002	Shower Arm	Chrome	---	\$11.00
	OP-640038	1.75 GPM Shower Head	Chrome	---	\$30.00
	OP-640042	1.75 GPM Rain Showerhead (For P-2394T, P-2395T, P-2398T)	Chrome	---	\$52.00
	X-6400088	1.75 GPM Shower Head (For P-2394T-6, P-2395T-6, P-2398T-6)	Chrome	---	\$49.50
	OP-440055	Face Plate	Chrome	---	\$19.00
	OP-140019	Lever Handle	Chrome	---	\$26.00
	OP-490011	3/32" Allen Wrench	---	---	\$0.70
	OP-640046	Diverter Tub Spout (For P-2390T)	Chrome	---	\$23.00
	OP-440055	Spout Escutcheon	Chrome	---	\$19.00
	OP-640019	Non Diverter Tub Spout	Chrome	---	\$13.30
	OP-640043	7" Extended Diverter Tub Spout	Chrome	---	\$89.00
	OP-640044	7" Extended Non-Diverter Tub Spout	Chrome	---	\$89.00
	OP-440054	Sleeve	Chrome	---	\$6.00
	OP-440043	Allen Screw	---	---	\$1.00
	OP-440010	Face Plate Screws	---	---	\$3.00

ACCENT // Single Handle Kitchen Faucets

SINGLE HANDLE KITCHEN FAUCETS









	Model#	Description	Finish	Case	Price
	K-5040	Single Handle Pull-Down Kitchen Faucet Lever Handle	Chrome	6	\$225.00
	K-5040-BN	Pull-Down Head with 2 Spray Patterns Swivel 360° 8" Reach, 7-1/2" From Deck to Aerator	PVD Brushed Nickel	6	\$281.00
	K-5040-ORB	Ceramic Disc Cartridge with Temperature Limit Stop 1 or 3-Hole 8" Installation	Oil Rubbed Bronze	6	\$314.50
	K-5040-MZ	Ball Joint Swivel Spray Head Easy-Install 30" Flex Supply Lines With 3/8" Connections Quick Connect Spray Head Hose and Weight, Easy-in- stall mounting nut With 1.8 GPM Flow Rate Deck Cover Plate Included	Moroccan Bronze	6	\$330.50
	K-5040-E1.5	With 1.5 GPM Flow Rate	Chrome	6	\$226.00
	K-5040-E1.5-BN		PVD Brushed Nickel	6	\$282.00
	K-5441	Single Handle Kitchen Faucet Lever Handle	Chrome	6	\$253.50
	K-5441-BN	Gooseneck Spout Swivel 360° 8-1/4" Reach, 10-3/8" From Deck to Aerator Ceramic Disc Cartridge with Temperature Limit Stop 2 or 4-Hole Installation Side Spray Assembly With 1.5 GPM Flow Rate	PVD Brushed Nickel	6	\$305.50
PARTS	OP-120002	Lever Handle	Chrome	---	\$15.90
	OP-320002	Ceramic Cartridge	---	---	\$14.80
	OP-420062	Hose Weight	---	---	\$9.80
	OP-420024	Diverter Piston	---	---	\$5.30
	OP-420038	Hose And Spray Assembly	Chrome	---	\$21.00
	OP-420039	Spray Head and Hose	Chrome	---	\$31.70
	OP-420041	Spout Repair Kit	---	---	\$0.90
	OP-420042	Retainer Nut	---	---	\$3.20
	OP-420043	Cap	Chrome	---	\$6.40
	OP-420044	Washer	---	---	\$0.70
	OP-420045	Deck Plate	Chrome	---	\$12.60
	OP-420046	Spray Head Push Button	---	---	\$1.10
	OP-420047	Allen Screw	---	---	\$0.70
	OP-420049	Spout Repair Kits	---	---	\$5.30
	OP-420050	Cap & Washer	---	---	\$2.40
	OP-520005	Mounting Kit	---	---	\$4.20
	OP-520012	Mounting Tool	---	---	\$18.90
	OP-420064	Spray Head-1.8 GPM	Chrome	---	\$31.70
	OP-420040	Spray Head and Hose-1.5 GPM	Chrome	---	\$38.80
	OP-420048	Aerator-1.5 GPM	Chrome	---	\$6.40

Low flow spray head available upon request for the K-5040.
See page 3 for special order finish options.

Olympia faucets feature aerators that meet ANSI/ASME A112.18.1 flow requirements of 1.8 GPM

ACCENT // Two Handle Kitchen Faucets

TWO HANDLE KITCHEN FAUCETS

		Model#	Description	Finish	Case	Price
		K-5340	Two Handle Kitchen Faucet Lever Handles	Chrome	6	\$88.50
		K-5340-BN	Gooseneck Spout Swivel 360° 8-7/16" Reach, 8-1/8" From Deck to Aerator	PVD Brushed Nickel	6	\$128.00
		K-5350*	Washerless Cartridge Operation 3-Hole 8" Installation With 1.5 GPM Flow Rate *ADA Wrist Blade Handles	Chrome	6	\$93.00
		K-5342	Two Handle Kitchen Faucet Lever Handles	Chrome	6	\$108.00
		K-5342-BN	Gooseneck Spout Swivel 360° 8-7/16" Reach, 8-1/8" From Deck to Aerator	PVD Brushed Nickel	6	\$152.50
		K-5342-ORB	Washerless Cartridge Operation 4-Hole 8" Installation With 1.5 GPM Flow Rate Side Spray Assembly	Oil Rubbed Bronze	6	\$171.00
		K-5370	Two Handle Kitchen Faucet Lever Handles	Chrome	6	\$93.50
		K-5370-BN	Gooseneck Spout Swivel 360° 8-7/16" Reach, 8-1/8" From Deck to Aerator Washerless Cartridge Operation 3-Hole 8" Installation With 1.5 GPM Flow Rate	PVD Brushed Nickel	6	\$135.50
		K-5372	Two Handle Kitchen Faucet Lever Handles	Chrome	6	\$113.00
		K-5372-BN	Gooseneck Spout Swivel 360° 8-7/16" Reach, 8-1/8" From Deck to Aerator Washerless Cartridge Operation 4-Hole 8" Installation With 1.5 GPM Flow Rate Side Spray Assembly	PVD Brushed Nickel	6	\$157.00

See page 3 for special order finish options.

Olympia faucets feature aerators that meet ANSI/ASME A112.18.1 flow requirements of 1.5 GPM

ACCENT

ACCENT // Two Handle Kitchen Faucets









TWO HANDLE KITCHEN FAUCETS

PARTS	Part Number	Description	Finish	Availability	Price
	OP-190010C	Lever Handle-Cold	Chrome	---	\$13.30
	OP-190010H	Lever Handle-Hot	Chrome	---	\$13.30
	OP-190014C	ADA Wrist Blade Handle-Cold	Chrome	---	\$13.30
	OP-190014H	ADA Wrist Blade Handle-Hot	Chrome	---	\$13.30
	OP-190015C	Lever Handle-Cold	Chrome	---	\$14.30
	OP-190015H	Lever Handle-Hot	Chrome	---	\$14.30
	OP-220004	High Gooseneck Spout	Chrome	---	\$34.70
	OP-220005	High Gooseneck Spout	Chrome	---	\$28.60
	OP-390004	Stem Unit-Brass Post	---	---	\$4.60
	OP-420051	Hose and Spray Assembly	Black	---	\$23.00
	OP-420024	Diverter Piston	---	---	\$5.30
	OP-420025	Deck Plate	Chrome	---	\$12.30
	OP-420026	Mounting Gasket	---	---	\$1.20
	OP-420038	Hose And Spray Assembly	Chrome	---	\$21.00
	OP-450010	Spout Bonnet Nut	Chrome	---	\$8.70
	OP-490028	Spout Bonnet Nut	Chrome	---	\$7.60
	OP-490029	Handle Set Screw	---	---	\$0.70
	OP-490038	Snap Ring	---	---	\$0.70
	OP-490039	Spout O-Ring	---	---	\$0.70
	OP-490040	Bonnet Nut	---	---	\$2.40
	OP-490041	Springs and Seats	---	---	\$1.20
	OP-590001	Brass Supply Nut	---	---	\$1.20
	OP-520009	Mounting Hardware	---	---	\$3.40
	OP-490057	Aerator-1.5 GPM	Chrome	---	\$8.80
	OP-490060	Aerator-1.0 GPM	Chrome	---	\$11.10
	OP-490061	Aerator-0.5 GPM	Chrome	---	\$11.10
	OP-490035	Aerator-1.5 GPM	Chrome	---	\$6.90
	OP-490056	Aerator-1.0 GPM	Chrome	---	\$9.90
	OP-490055	Aerator-0.5 GPM	Chrome	---	\$8.80

Olympia faucets feature aerators that meet ANSI/ASME A112.18.1 flow requirements of 1.5 GPM

ACCENT // Two Handle Bar Faucets

TWO HANDLE BAR FAUCETS







		Model#	Description	Finish	Case	Price
	  	B-8160	Two Handle Bar Faucet Lever Handles	Chrome	12	\$74.00
		B-8160-BN	Gooseneck Spout Swivel 360° 5-1/4" Reach, 5-13/16" From Deck to Aerator Washerless Cartridge Operation 2 or 3-Hole 4" Installation With 1.5 GPM Flow Rate	PVD Brushed Nickel	12	\$93.50
	  	B-8150	Two Handle Bar Faucet Lever Handles	Chrome	12	\$79.00
		B-8150-BN	Gooseneck Spout Swivel 360° 5-1/4" Reach, 5-13/16" From Deck to Aerator Washerless Cartridge Operation 2 or 3-Hole 4" Installation With 1.5 GPM Flow Rate	PVD Brushed Nickel	12	\$100.00
PARTS		OP-190010C	Lever Handle-Cold	Chrome	---	\$13.30
		OP-190010H	Lever Handle-Hot	Chrome	---	\$13.30
		OP-190015C	Lever Handle-Cold	Chrome	---	\$14.30
		OP-190015H	Lever Handle-Hot	Chrome	---	\$14.30
		OP-250002	8-15/16" High Spout	Chrome	---	\$30.10
		OP-390004	Stem Unit-Brass Post	---	---	\$4.60
		OP-450002	Bonnet Nut	Chrome	---	\$2.40
		OP-450003	Bonnet Nut Gasket	---	---	\$0.70
		OP-450004	Deck Plate	Chrome	---	\$11.00
		OP-450005	Mounting Gasket	---	---	\$1.80
		OP-490028	Spout Bonnet Nut	Chrome	---	\$7.60
		OP-490029	Handle Set Screw	---	---	\$0.70
		OP-490038	Snap Ring	---	---	\$0.70
		OP-490039	Spout O-Ring	---	---	\$0.70
		OP-490041	Springs and Seats	---	---	\$1.20
		OP-590001	Brass Supply Nut	---	---	\$1.20
		OP-590003	Mounting Hardware	---	---	\$2.40
		OP-490057	Aerator-1.5 GPM	Chrome	---	\$8.80
		OP-490060	Aerator-1.0 GPM	Chrome	---	\$11.10
		OP-490061	Aerator-0.5 GPM	Chrome	---	\$11.10
		OP-490035	Aerator-1.5 GPM	Chrome	---	\$6.90
		OP-490056	Aerator-1.0 GPM	Chrome	---	\$9.90
		OP-490055	Aerator-0.5 GPM	Chrome	---	\$8.80

See page 3 for special order finish options.

Olympia faucets feature aerators that meet ANSI/ASME A112.18.1 flow requirements of 1.5 GPM

ACCENT // Two Handle Lavatory Faucets

TWO HANDLE LAVATORY FAUCETS

	Model#	Description	Finish	Case	Price
	L-7240	Two Handle Lavatory Faucet Lever Handles	Chrome	12	\$74.00
	L-7240-BN	4-1/8" Reach, 1-3/4" From Deck to Aerator Washerless Cartridge Operation	PVD Brushed Nickel	12	\$94.00
	L-7240-ORB	3-Hole 4" Installation	Oil Rubbed Bronze	12	\$105.00
	L-7240B*	With 1.2 GPM Flow Rate 50/50 Pop-Up Drain Assembly	Chrome	12	\$72.00
	L-7240B-BN*	*Builder Tract Pack	PVD Brushed Nickel	12	\$92.00
	L-7240-E1.0	With 1.0 GPM Flow Rate	Chrome	12	\$76.00
	L-7240-E1.0-BN		PVD Brushed Nickel	12	\$97.00
	L-7240-E1.0-ORB		Oil Rubbed Bronze	12	\$108.00
	L-7241	Two Handle Lavatory Faucet Lever Handles	Chrome	12	\$64.00
	L-7241-BN	4-1/8" Reach, 1-3/4" From Deck to Aerator Washerless Cartridge Operation 3-Hole 4" Installation With 1.2 GPM Flow Rate	PVD Brushed Nickel	12	\$77.50
	L-7242	Two Handle Lavatory Faucet Lever Handles	Chrome	12	\$82.00
	L-7242-BN	4-1/8" Reach, 1-3/4" From Deck to Aerator Washerless Cartridge Operation	PVD Brushed Nickel	12	\$104.00
	L-7242-ORB	3-Hole 4" Installation	Oil Rubbed Bronze	12	\$114.50
	L-7242-MZ	With 1.2 GPM Flow Rate Brass Pop-Up Drain Assembly	Moroccan Bronze	12	\$120.50
	L-7242B*	*Builder Tract Pack	Chrome	12	\$80.00
	L-7242-E1.0	With 1.0 GPM Flow Rate	Chrome	12	\$84.00
	L-7242-E1.0-BN		PVD Brushed Nickel	12	\$106.50
	L-7270	Two Handle Lavatory Faucet Lever Handles	Chrome	12	\$79.00
	L-7270-BN	4-1/8" Reach, 1-3/4" From Deck to Aerator Washerless Cartridge Operation 3-Hole 4" Installation With 1.2 GPM Flow Rate 50/50 Pop-Up Drain Assembly	PVD Brushed Nickel	12	\$99.00
	L-7270-E1.0	With 1.0 GPM Flow Rate	Chrome	12	\$82.00
	L-7270-E1.0-BN		PVD Brushed Nickel	12	\$102.00
	L-7271	Two Handle Lavatory Faucet Lever Handles 4-1/8" Reach, 1-3/4" From Deck to Aerator Washerless Cartridge Operation 3-Hole 4" Installation With 1.2 GPM Flow Rate	Chrome	12	\$69.00
	L-7272	Two Handle Lavatory Faucet Lever Handles	Chrome	12	\$84.00
	L-7272-BN	4-1/8" Reach, 1-3/4" From Deck to Aerator Washerless Cartridge Operation	PVD Brushed Nickel	12	\$107.50
	L-7272B*	3-Hole 4" Installation With 1.2 GPM Flow Rate Brass Pop-Up Drain Assembly *Builder Tract Pack	Chrome	12	\$82.00

Builder Tract Packs sold in case quantities only.
See page 3 for special order finish options.

Olympia faucets feature aerators that meet ANSI/ASME A112.18.1 flow requirements of 1.5 GPM





ACCENT // Two Handle Lavatory Faucets

TWO HANDLE LAVATORY FAUCETS

	Model#	Description	Finish	Case	Price
PARTS	OP-190010C	Lever Handle-Cold	Chrome	---	\$13.30
	OP-190010H	Lever Handle-Hot	Chrome	---	\$13.30
	OP-190015C	Lever Handle-Cold	Chrome	---	\$14.30
	OP-190015H	Lever Handle-Hot	Chrome	---	\$14.30
	OP-390004	Stem Unit-Brass Post	---	---	\$4.60
	OP-430005	Lift Rod Hole Cover Button	Chrome	---	\$0.70
	OP-490029	Handle Set Screw	---	---	\$0.70
	OP-490040	Bonnet Nut	---	---	\$2.40
	OP-490041	Springs and Seats	---	---	\$1.20
	OP-590001	Brass Supply Nut	---	---	\$1.20
	OP-590003	Mounting Hardware	---	---	\$2.40
	OP-630002	Brass Pop-Up Drain Assembly	Chrome	---	\$27.10
	OP-630004	50/50 Pop-Up Drain Assembly	Chrome	---	\$22.00
	OP-430007	Aerator-1.5 GPM	Chrome	---	\$7.50
	OP-430012	Aerator-1.0 GPM	Chrome	---	\$10.50
	OP-430011	Aerator-0.5 GPM	Chrome	---	\$8.80

ACCENT // Two Handle Lavatory Faucets

TWO HANDLE LAVATORY FAUCETS



	Model#	Description	Finish	Case	Price
	L-7470	Two Handle Lavatory Faucet Lever Handles	Chrome	6	\$205.00
	L-7470-BN	J Style Rigid Spout	PVD Brushed Nickel	6	\$240.00
	L-7470-ORB	4-3/4" Reach, 3-11/16" From Deck to Aerator Ceramic Disc Cartridges 3-Hole 4" to 16" Installation Easy-Install 18" Flex Supply Lines With 3/8" Connections 50/50 Pop-Up Drain Assembly With 1.2 GPM Flow Rate	Oil Rubbed Bronze	6	\$245.00
	L-7472	Two Handle Lavatory Faucet Lever Handles	Chrome	6	\$210.00
	L-7472-BN	J Style Rigid Spout	PVD Brushed Nickel	6	\$245.00
	L-7472-ORB	4-3/4" Reach, 3-11/16" From Deck to Aerator Ceramic Disc Cartridges 3-Hole 4" to 16" Installation Easy-Install 18" Flex Supply Lines With 3/8" Connections Brass Pop-Up Drain Assembly With 1.2 GPM Flow Rate	Oil Rubbed Bronze	6	\$253.00
	L-7570	Two Handle Lavatory Faucet Lever Handles	Chrome	12	\$135.00
	L-7570-BN	J Style Rigid Spout	PVD Brushed Nickel	12	\$164.70
	L-7570-ORB	4-1/16" Reach, 3-11/16" From Deck to Aerator Ceramic Disc Cartridges	Oil Rubbed Bronze	12	\$173.00
	L-7570B*	3-Hole 4" Installation 50/50 Pop-Up Drain Assembly With 1.2 GPM Flow Rate	Chrome	12	\$133.00
	L-7570B-BN*	*Builder Tract Pack	PVD Brushed Nickel	12	\$162.70
	L-7572	Two Handle Lavatory Faucet Lever Handles	Chrome	12	\$140.00
	L-7572-BN	J Style Rigid Spout	PVD Brushed Nickel	12	\$170.80
	L-7572-ORB	4-1/16" Reach, 3-11/16" From Deck to Aerator Ceramic Disc Cartridges	Oil Rubbed Bronze	12	\$179.40
	L-7572B*	3-Hole 4" Installation Brass Pop-Up Drain Assembly With 1.2 GPM Flow Rate *Builder Tract Pack	Chrome	12	\$138.00
PARTS	OP-490011	3/32" Allen Wrench	---	---	\$0.70
	OP-190015C	Lever Handle-Cold	---	---	\$14.30
	OP-190015H	Lever Handle-Hot	---	---	\$14.30
	OP-430027	Valve Escutcheon	Polish Chrome Finish	---	\$11.40
	OP-330002C	Ceramic Stem - Cold	---	---	\$8.00
	OP-330002H	Ceramic Stem - Hot	---	---	\$8.00
	OP-590002	Valve Mounting Hardware	---	---	\$5.90
	OP-590001	Brass Supply Nut	---	---	\$1.20
	OP-490009	Y Connector Set	---	---	\$20.40
	OP-430001	Spout Mounting Hardware	---	---	\$3.50
	OP-230005	J Style Spout	Polished Chrome Finish	---	\$145.00
	OP-630004	50/50 Pop-Up Drain Assembly	---	---	\$22.00
	OP-490029	Handle 3/32" Allen Screw	---	---	\$0.70
	OP-490010	Aerator-1.5 GPM	---	---	\$5.70
	OP-430028	Gasket	---	---	\$0.70
	OP-630002	Brass Pop-Up Drain Assembly	---	---	\$27.10
	OP-450002	Bonnet Nut	---	---	\$2.40
	OP-430029	Bonnet Nut Gasket	---	---	\$0.70
	OP-450005	Mounting Gasket	---	---	\$1.80
	OP-590003	Mounting Hardware	---	---	\$2.40

Builder Tract Packs sold in case quantities only.
Low flow aerators available upon request.

Olympia faucets feature aerators that meet ANSI/ASME A112.18.1 flow requirements of 1.5 GPM

ACCENT // Two Handle Lavatory Faucets

TWO HANDLE LAVATORY FAUCETS









	Model#	Description	Finish	Case	Price
	L-7330	Two Handle Lavatory Widespread Faucet Lever Handles	Chrome	6	\$156.00
	L-7330-BN	C Style Rigid Spout 4-9/16" Reach, 1-7/8" From Deck to Aerator	PVD Brushed Nickel	6	\$199.00
	L-7330-ORB	Ceramic Disc Cartridge 3-Hole 4" to 16" Installation Easy-Install 18" Flex Supply Lines With 3/8" Connections With 1.2 GPM Flow Rate 50/50 Pop-Up Drain Assembly	Oil Rubbed Bronze	6	\$223.00
	L-7330-E1.0	With 1.0 GPM Flow Rate	Chrome	6	\$159.00
	L-7330-E1.0-BN		PVD Brushed Nickel	6	\$201.00
	L-7332	Two Handle Lavatory Widespread Faucet Lever Handles	Chrome	6	\$161.00
	L-7332-BN	C Style Rigid Spout 4-9/16" Reach, 1-7/8" From Deck to Aerator	PVD Brushed Nickel	6	\$208.00
	L-7332-ORB	Ceramic Disc Cartridge 3-Hole 4" to 16" Installation Easy-Install 18" Flex Supply Lines With 3/8" Connections With 1.2 GPM Flow Rate Brass Pop-Up Drain Assembly	Oil Rubbed Bronze	6	\$233.00
	L-7372	Two Handle Lavatory Widespread Faucet Lever Handles	Chrome	6	\$166.00
	L-7372-BN	C Style Rigid Spout 4-9/16" Reach, 1-7/8" From Deck to Aerator	PVD Brushed Nickel	6	\$213.00
	L-7372-ORB	Ceramic Disc Cartridge 3-Hole 4" to 16" Installation Easy-Install 18" Flex Supply Lines With 3/8" Connections With 1.2 GPM Flow Rate Brass Pop-Up Drain Assembly	Oil Rubbed Bronze	6	\$238.50
PARTS	OP-190010C	Lever Handle-Cold	Chrome	---	\$13.30
	OP-190010H	Lever Handle-Hot	Chrome	---	\$13.30
	OP-190015C	Lever Handle-Cold	Chrome	---	\$14.30
	OP-190015H	Lever Handle-Hot	Chrome	---	\$14.30
	OP-230001	C Style Spout	Chrome	---	\$115.30
	OP-390004	Stem Unit-Brass Post	---	---	\$4.60
	OP-430001	Spout Mounting Hardware	---	---	\$3.50
	OP-490006	Bonnet Nut	---	---	\$5.30
	OP-490007	Valve Escutcheon	Chrome	---	\$11.40
	OP-490009	Y Connector Set	---	---	\$20.40
	OP-490030	Extension Kit	---	---	\$44.50
	OP-490041	Springs and Seats	---	---	\$1.20
	OP-590002	Valve Mounting Hardware	---	---	\$5.90
	OP-630002	Brass Pop-Up Drain Assembly	Chrome	---	\$27.10
	OP-630004	50/50 Pop-Up Drain Assembly	Chrome	---	\$22.00
	OP-430007	Aerator-1.5 GPM	Chrome	---	\$7.50
	OP-490058	Aerator-1.0 GPM	Chrome	---	\$8.80
OP-490008	Flex Connector Hose	---	---	\$6.90	

See page 3 for special order finish options.

Olympia faucets feature aerators that meet ANSI/ASME A112.18.1 flow requirements of 1.5 GPM

ACCENT // Pressure Balance Trim Sets

PRESSURE BALANCE TRIM SETS









	Model#	Description	Finish	Case	Price		
	 	P-2340T Single Handle Tub/Shower Trim Set Lever Handle P-2340T-BN Face Plate P-2340T-ORB Three Function 2-1/2" Pulsating Showerhead, Arm & Flange P-2340T-MZ Combo 1/2" IPS/Slip-On Diverter Tub Spout With 1.75 GPM Flow Rate For Use with P-2300B & P-2400B Series Valves - Valve not included	Chrome PVD Brushed Nickel Oil Rubbed Bronze Moroccan Bronze	12 12 12 12	\$69.00 \$117.50 \$135.00 \$142.00		
		P-2342T Single Handle Shower Trim Set Lever Handle P-2342T-BN Face Plate P-2342T-ORB Three Function 2-1/2" Pulsating Showerhead, Arm & Flange P-2342T-MZ With 1.75 GPM Flow Rate For Use with P-2300B & P-2400B Series Valves - Valve not included	Chrome PVD Brushed Nickel Oil Rubbed Bronze Moroccan Bronze	12 12 12 12	\$53.00 \$94.00 \$108.00 \$113.50		
		 	P-2350T Single Handle Tub/Shower Trim Set Lever Handle P-2350T-BN Face Plate Four Function 3-3/8" Showerhead, Arm & Flange Combo 1/2" IPS/Slip-On Diverter Tub Spout with Escutcheon With 1.75 GPM Flow Rate For Use with P-2300B & P-2400B Series Valves - Valve not included	Chrome PVD Brushed Nickel	12 12	\$86.50 \$141.00	
			P-2351T Single Handle Tub Trim Set Lever Handle Face Plate Combo 1/2" IPS/Slip-On Tub Spout with Escutcheon For Use with P-2300B & P-2400B Series Valves - Valve not included	Chrome	12	\$70.50	
			P-2352T Single Handle Shower Trim Set Lever Handle P-2352T-BN Face Plate Four Function 3-3/8" Showerhead, Arm & Flange With 1.75 GPM Flow Rate For Use with P-2300B & P-2400B Series Valves - Valve not included	Chrome PVD Brushed Nickel	12 12	\$70.50 \$125.00	
			 	P-2353T Single Handle Tub/Shower Trim Set Lever Handle P-2353T-BN Face Plate Four Function 3-3/8" Showerhead, Arm & Flange Extended Combo 1/2" IPS/Slip-On Diverter Tub Spout with Escutcheon With 1.75 GPM Flow Rate For Use with P-2300B & P-2400B Series Valves - Valve not included	Chrome PVD Brushed Nickel	12 12	\$103.00 \$173.00
				P-2354T Single Handle Tub Trim Set Lever Handle P-2354T-BN Face Plate Extended Combo 1/2" IPS/Slip-On Tub Spout with Escutcheon For Use with P-2300B & P-2400B Series Valves - Valve not included	Chrome PVD Brushed Nickel	12 12	\$81.00 \$135.75

Low flow showerheads available upon request.
See page 3 for special order finish options.

Olympia showerheads meet ANSI/ASME A112.18.1 flow requirements of maximum 1.75 GPM

ACCENT // Pressure Balance Trim Sets

PRESSURE BALANCE TRIM SETS



		Model#	Description	Finish	Case	Price
		P-2343T	Single Handle Valve Trim Set Lever Handle	Chrome	12	\$37.00
		P-2343T-BN	Face Plate For Use with P-2300B & P-2400B Series Valves - Valve not included	PVD Brushed Nickel	12	\$63.00
  	 	P-2360T	Single Handle Tub/Shower Trim Set Lever Handle	Chrome	12	\$73.00
		P-2360T-BN	Face Plate Three Function 2-1/2" Pulsating Showerhead, Arm & Flange Combo 1/2" IPS/Slip-On Diverter Tub Spout With 1.75 GPM Flow Rate For Use with P-2300B & P-2400B Series Valves - Valve not included	PVD Brushed Nickel	12	\$120.00
		P-2362T	Single Handle Shower Trim Set Lever Handle	Chrome	12	\$57.00
		P-2362T-BN	Face Plate Three Function 2-1/2" Pulsating Showerhead, Arm & Flange For Use with P-2300B & P-2400B Series Valves - Valve not included	PVD Brushed Nickel	12	\$98.00
		P-2363T	Single Handle Valve Trim Set Lever Handle Face Plate For Use with P-2300B & P-2400B Series Valves - Valve not included	Chrome	12	\$41.00
PARTS		OP-140008	Lever Handle	Chrome	---	\$17.90
		OP-440009	Face Plate Set	Chrome	---	\$20.40
		OP-640029	Three Functions Pulsating Showerhead 1.75 GPM	Chrome	50	\$25.50
		OP-640002	6" Shower Arm	Chrome	---	\$11.00
		OP-640001	Shower Arm Flange	Chrome	---	\$1.20
		OP-490011	3/32" Allen Wrench	---	---	\$0.70
		OP-640018	Combo Diverter Tub Spout	Chrome	50	\$19.90
		OP-490029	Handle 3/32" Allen Screw	---	---	\$0.70
		OP-440033	Adapter	---	---	\$4.10
		OP-440010	Face Plate Screw	Chrome	---	\$3.00
		OP-440011	Face Plate Rubber Gasket	---	---	\$2.40
		OP-440054	Sleeve	Chrome	---	\$6.00
		OP-140015	Lever Handle (P-2360T Series)	Chrome	---	\$21.00
		OP-640016	Three Functions Pulsating Showerhead	Chrome	100	\$20.40
		OP-640035	Four Functions Showerhead 1.75 GPM	Chrome	70	\$33.70
		OP-440042	Tub Spout Escutcheon	Chrome	---	\$9.00

Low flow showerheads available upon request.
See page 3 for special order finish options.

Olympia showerheads meet ANSI/ASME A112.18.1 flow requirements of maximum 1.75 GPM

ACCENT // 2/3 Handle Tub/Shower Sets

TWO & THREE HANDLE TUB / SHOWER SETS

	Model#	Description	Finish	Case	Price
	P-3250	Three Handle Tub/Shower Set Lever Handles	Chrome	6	\$149.00
	P-3250-BN	1/2" IPS Female Inlets Washerless Cartridge Operation Single Function 2-1/4" Standard Showerhead, Arm & Flange 1/2" IPS Tub Spout With 2.5 GPM Flow Rate 8" Cast Brass Valve body Included	PVD Brushed Nickel	6	\$198.00
	P-1250	Two Handle Tub/Shower Set Lever Handles	Chrome	12	\$126.00
	P-1250-BN	Built-in Transfer Valve 1/2" IPS Female Inlets Washerless Cartridge Operation Single Function 2-1/4" Standard Showerhead, Arm & Flange With 2.5 GPM Flow Rate 1/2" IPS Diverter Tub Spout 8" Cast Brass Valve body Included	PVD Brushed Nickel	12	\$187.50
PARTS	OP-140009	Lever Handle	Chrome	---	\$10.40
	OP-190015C	Lever Handle-Cold	Chrome	---	\$14.30
	OP-340006C	Cartridge Unit-Cold	---	---	\$4.10
	OP-340006H	Cartridge Unit-Hot	---	---	\$4.10
	OP-340007	Diverter Stem Unit	---	---	\$5.90
	OP-440015	Tailpiece Union	---	---	\$4.10
	OP-440016	Tailpiece Locknut	---	---	\$4.60
	OP-440017	Mounting Mud Guard	---	---	\$1.10
	OP-440034	Diverter Piston	---	---	\$1.80
	OP-440035	Stem Extension	---	---	\$3.50
	OP-440036	Sleeve	Chrome	---	\$11.60
	OP-440037	Flange	Chrome	---	\$6.50
	OP-490011	Allen Wrench 3/32"	---	---	\$0.70
	OP-490041	Springs and Seats	---	---	\$1.20
	OP-640001	Shower Arm Flange	Chrome	---	\$1.20
	OP-640002	6" Shower Arm	Chrome	---	\$11.00
	OP-640003	Single Function Standard Showerhead	Chrome	---	\$15.90
OP-640014	1/2" IPS Tub Spout	Chrome	---	\$9.90	
OP-640015	1/2" IPS Diverter Tub Spout	Chrome	---	\$15.70	





Low flow spray head available upon request.
See page 3 for special order finish options.

Olympia faucets feature aerators that meet ANSI/ASME A112.18.1 flow requirements of 1.5 GPM

ACCENT // Handheld Shower

NEW SHOWERS

HANDHELD SHOWER SETS

	Model#	Description	Finish	Case	Price	
	P-4420	Handheld Shower Set Five Functions Handheld Showerhead	Chrome	12	\$151.00	
	P-4420-BN	24" Slide Bar with Brass Mounts	PVD Brushed Nickel	12	\$260.00	
	P-4420-ORB	60" Stainless Steel Flex Hose Shower Arm 2-Way Diverter Divert Water To Showerhead or Handheld Showerhead	Oil Rubbed Bronze	12	\$286.00	
		P-4430	Handheld Shower Set Five Functions Handheld Showerhead	Chrome	12	\$144.00
		P-4430-BN	24" Slide Bar with Brass Mounts	PVD Brushed Nickel	12	\$248.00
		P-4430-ORB	60" Stainless Steel Flex Hose Brass Drop Ell with Vacuum Breaker	Oil Rubbed Bronze	12	\$273.00
		P-4430-MZ	Valve Sold Separately	Moroccan Bronze	12	\$287.00
		P-4430-E1.5	With 1.5 GPM Flow Rate	Chrome	12	\$145.50
		P-4430-E1.5-BN		PVD Brushed Nickel	12	\$249.50
		P-4440	Handheld Shower Set Five Functions Handheld Showerhead	Chrome	12	\$162.00
P-4440-BN		24" Grab/Slide Bar with Mounts 60" Stainless Steel Flex Hose Brass Drop Ell with Vacuum Breaker With 1.75 GPM Flow Rate Valve Sold Separately	PVD Brushed Nickel	12	\$266.00	
	P-2240T	Single Handle Diverter Set Lever Handle	Chrome	20	\$24.50	
	P-2240T-BN	Diverter Valve Face Plate	PVD Brushed Nickel	20	\$47.00	
	P-2240T-ORB	Diverter Valve Sleeve For Use with P-2240B Valve - Valve not included	Oil Rubbed Bronze	20	\$60.50	
PARTS	OP-660003	Handheld Showerhead	Chrome	---	\$34.70	
	OP-660009	Handheld Showerhead - 1.5 GPM	Chrome	---	\$43.00	
	OP-460021	60" SST Hose	---	---	\$23.00	
	OP-460022	60" SST Hose	---	---	\$4.35	
	OP-460020	Vacuum Breaker	Chrome	---	\$12.30	
	OP-460013	Two Way Diverter	Chrome	---	\$26.10	
	OP-560001	Mounting Kit	---	---	\$1.80	
	OP-460009B/T	Brass Mounts	---	---	\$22.00	
	OP-460010	24" Slide Bar	Chrome	---	\$83.20	
	OP-490011	3/32" Allen Wrench	---	---	\$0.70	
	OP-460011	Mounting Screw	---	---	\$0.20	
	OP-490029	3/32" Allen Screw	---	---	\$0.10	

Low flow showerheads available upon request.
See page 3 for special order finish options.

Olympia showerheads meet ANSI/ASME A112.18.1 flow requirements of maximum 1.75 GPM

ACCENT // Roman Tub Trims

ROMAN TUB TRIM SETS

	Model#	Description	Finish	Case	Price
	P-1131T	Two Handle Roman Tub Trim Set	Chrome	6	\$160.00
	P-1131T-BN	Lever Handles C Style Rigid Spout	PVD Brushed Nickel	6	\$192.00
	P-1131T-ORB	7-1/2" Reach 3-Hole 8" to 16" Installation	Oil Rubbed Bronze	6	\$215.00
	P-1131T-MZ	Trim Only, P-1131B Valve Required	Moroccan Bronze	6	\$226.00
PARTS	OP-490011	Allen Wrench 3/32"	---	---	\$0.70
	OP-140007	Lever Handle	Chrome	---	\$32.20
	OP-490044	Stem Extension	---	---	\$4.60
	OP-440031	Valve Escutcheon	Chrome	---	\$27.10
	OP-240007	C Spout	Chrome	---	\$130.10
	OP-440029	C Spout Allen Screw	---	---	\$0.70
	OP-440027	Male Thread Streamer	Chrome	---	\$5.30
	OP-490036	Allen Wrench 1/8"	---	---	\$0.70
	OP-440028	C Spout Button	Chrome	---	\$0.70
	OP-440030	Spout Escutcheon	Chrome	---	\$21.50

Low flow showerheads available upon request.
See page 3 for special order finish options.

Olympia showerheads meet ANSI/ASME A112.18.1 flow requirements of maximum 1.75 GPM

ELITE // Single Handle Kitchen Faucets

SINGLE HANDLE PULL-OUT KITCHEN FAUCETS

	Model#	Description	Finish	Case	Price
	K-5030	Single Handle Pull-Out Kitchen Faucet Metal Lever Handle	Chrome	6	\$163.00
	K-5030-BN	Pull-Out Head with 2 Spray Patterns Swivel 180° 8-3/4" Reach, 5-3/16" From Deck to Aerator	PVD Brushed Nickel	6	\$203.50
	K-5030-ORB	Ceramic Disc Cartridge with Temperature Limit Stop 1 or 3-Hole 8" Installation Easy-Install 30" Flex Supply Lines With 3/8" Connections Quick Connect Spray Head Hose and Weight, Easy-install mounting nut With 1.8 GPM Flow Rate Deck Cover Plate Included	Oil Rubbed Bronze	6	\$224.00
	K-5030-E1.5	With 1.5 GPM Flow Rate	Chrome	6	\$165.00
	K-5030-E1.5-BN		PVD Brushed Nickel	6	\$205.50
	K-5030-E1.5-ORB		Oil Rubbed Bronze	6	\$226.00
	PARTS	OP-120001	Metal Lever Handle Set	Chrome	---
OP-120003		Metal Loop Handle Set	Chrome	---	\$22.00
OP-320001		Ceramic Cartridge	---	---	\$13.80
OP-420008		Cap	Chrome	---	\$5.30
OP-420009		Retainer Ring	---	---	\$7.60
OP-420010		Spout O-Rings	---	---	\$0.70
OP-420011		Spray Head Guide	---	---	\$0.70
OP-420013		Deck Plate	Chrome	---	\$16.40
OP-420014		Hose Weight	---	---	\$9.80
OP-420015		Spray Hose	Chrome	---	\$27.60
OP-420017		Spray Head Button	---	---	\$0.70
OP-490005		Lever Handle Index Button	---	---	\$0.70
OP-490029		Handle Set Screw	---	---	\$0.70
OP-520003		Mounting Hardware	---	---	\$2.50
OP-520004		Locknut	---	---	\$3.00
OP-520006		1-Hole Mounting Assembly	Chrome	---	\$11.60
OP-520012		Mounting Tool	---	---	\$4.20
OP-420063		Spray Head-1.8 GPM	Chrome	---	\$22.00
OP-420012		Spray Head-1.5 GPM	Chrome	---	\$22.00











Low flow spray head available upon request.
See page 3 for special order finish options.

Olympia faucets feature aerators that meet ANSI/ASME A112.18.1 flow requirements of 1.5 GPM

ELITE

ELITE // Single Handle Kitchen Faucets

SINGLE HANDLE KITCHEN FAUCETS





		Model#	Description	Finish	Case	Price
		K-4160	Single Handle Kitchen Faucet Metal Lever Handle	Chrome	12	\$76.00
		K-4160-BN	Spout Swivel 360°	PVD Brushed Nickel	12	\$104.00
		K-4160-ORB	7-15/16" Reach, 4-3/4" From Deck to Aerator Stainless Steel Ball Operation	Oil Rubbed Bronze	12	\$116.50
		K-4160B*	3-Hole 8" Installation With 1.5 GPM Flow Rate	Chrome	12	\$74.00
		K-4160B-BN*	*Builder Tract Pack **Easy-Install 30" Flex Supply Lines With 3/8" Connections	PVD Brushed Nickel	12	\$102.00
		K-4160H**		Chrome	12	\$86.00
		K-4161	Single Handle Kitchen Faucet Metal Lever Handle	Chrome	12	\$90.50
		K-4161-BN	Spout Swivel 360°	Chrome	12	\$117.00
		K-4161B*	7-15/16" Reach, 4-3/4" From Deck to Aerator Stainless Steel Ball Operation	Chrome	12	\$88.50
		K-4161B-BN*	4-Hole 8" Installation With 1.5 GPM Flow Rate	PVD Brushed Nickel	12	\$115.00
		K-4161H**	Side Spray Assembly *Builder Tract Pack	Chrome	12	\$100.50
		K-4161H-BN**	**Easy-Install 30" Flex Supply Lines With 3/8" Connections	PVD Brushed Nickel	12	\$126.50
		K-4162	Single Handle Kitchen Faucet Metal Lever Handle	Chrome	12	\$100.00
		K-4162-BN	Spout Swivel 360°	PVD Brushed Nickel	12	\$129.50
		K-4162B*	7-15/16" Reach, 4-3/4" From Deck to Aerator Stainless Steel Ball Operation	Chrome	12	\$98.00
		K-4162H	4-Hole 8" Installation With 1.5 GPM Flow Rate Side Spray Assembly *Builder Tract Pack **Easy-Install 30" Flex Supply Lines With 3/8" Connections	Chrome	12	\$110.00
		K-4163	Single Handle Kitchen Faucet Metal Lever Handle Spout Swivel 360° 7-15/16" Reach, 4-3/4" From Deck to Aerator Stainless Steel Ball Operation 3-Hole 8" Installation With 1.5 GPM Flow Rate Side Spray Assembly On Deck	Chrome	12	\$93.00
		K-4164	Single Handle Kitchen Faucet Metal Lever Handle Spout Swivel 360° 7-15/16" Reach, 4-3/4" From Deck to Aerator Stainless Steel Ball Operation 3-Hole 8" Installation With 1.5 GPM Flow Rate Side Spray Assembly On Deck	Chrome	12	\$102.50

Builder Tract Packs sold in case quantities only.
Low flow spray head available upon request.
See page 3 for special order finish options.

Olympia faucets feature aerators that meet ANSI/ASME A112.18.1 flow requirements of 1.5 GPM

ELITE // Single Handle Kitchen Faucets

SINGLE HANDLE KITCHEN FAUCETS















		Model#	Description	Finish	Case	Price
		K-4170	Single Handle Kitchen Faucet Metal Loop Handle	Chrome	12	\$76.00
		K-4170-BN	Spout Swivel 360° 7-15/16" Reach, 4-3/4" From Deck to Aerator Stainless Steel Ball Operation 3-Hole 8" Installation With 1.5 GPM Flow Rate	PVD Brushed Nickel	12	\$99.50
		K-4171	Single Handle Kitchen Faucet Metal Loop Handle Spout Swivel 360° 7-15/16" Reach, 4-3/4" From Deck to Aerator Stainless Steel Ball Operation 4-Hole 8" Installation With 1.5 GPM Flow Rate Side Spray Assembly	Chrome	12	\$90.50
PARTS		OP-190001	Metal Lever Handle	Chrome	---	\$13.30
		OP-190002	Metal Loop Handle	Chrome	---	\$13.30
		OP-220001	D Style Spout	Chrome	---	\$37.30
		OP-390001	Stainless Steel Ball	---	---	\$3.50
		OP-420001	Spout O-Rings	---	---	\$0.70
		OP-420002	Spout Gasket	---	---	\$0.70
		OP-420003	Deck Plate	Chrome	---	\$20.40
		OP-420004	Mounting Gasket	---	---	\$1.80
		OP-420005	Diverter Piston	---	---	\$2.40
		OP-420006	Deck Plate	Chrome	---	\$13.80
		OP-420052	Hose And Spray Assembly	Black	---	\$23.00
		OP-420051	Hose And Spray Assembly	Black	---	\$23.00
		OP-420037	Hose And Spray Assembly	Chrome	---	\$19.40
		OP-420038	Hose And Spray Assembly	Chrome	---	\$21.00
		OP-490002	Lever Handle Index Button	---	---	\$0.70
		OP-490003	Cap and Adjusting Ring	Chrome	---	\$7.00
		OP-490004	Cam and Washer	---	---	\$4.60
		OP-490041	Springs and Seats	---	---	\$1.20
		OP-490043	Lever Handle Allen Screw 1/8"	---	---	\$0.70
		OP-520001	Mounting Hardware	---	---	\$1.80
		OP-520002	Mounting Hardware	---	---	\$2.20
		OP-590001	Brass Supply Nut	---	---	\$1.20
		OP-490035	Aerator-1.5 GPM	Chrome	---	\$6.90
	OP-490056	Aerator-1.0 GPM	Chrome	---	\$9.90	
	OP-490055	Aerator-0.5 GPM	Chrome	---	\$8.80	

See page 3 for special order finish options.

Olympia faucets feature aerators that meet ANSI/ASME A112.18.1 flow requirements of 1.5 GPM

ELITE // Two Handle Kitchen Faucets

TWO HANDLE KITCHEN FAUCETS







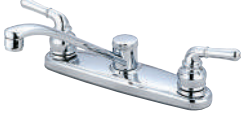

		Model#	Description	Finish	Case	Price
		K-5120	Two Handle Kitchen Faucet Acrylic Round Handles Spout Swivel 360° 7-9/16" Reach, 4-5/8" From Deck to Aerator Washerless Cartridge Operation 3-Hole 8" Installation With 1.5 GPM Flow Rate *Builder Tract Pack	Chrome	12	\$72.00
		K-5121	Two Handle Kitchen Faucet Acrylic Round Handles Spout Swivel 360° 7-9/16" Reach, 4-5/8" From Deck to Aerator Washerless Cartridge Operation 4-Hole 8" Installation With 1.5 GPM Flow Rate Side Spray Assembly	Chrome	12	\$82.00
		K-5130	Two Handle Kitchen Faucet Mini Blade Handles Spout Swivel 360° 7-9/16" Reach, 4-5/8" From Deck to Aerator Washerless Cartridge Operation 3-Hole 8" Installation With 1.5 GPM Flow Rate	Chrome	12	\$73.50
		K-5131	Two Handle Kitchen Faucet Mini Blade Handles Spout Swivel 360° 7-9/16" Reach, 4-5/8" From Deck to Aerator Washerless Cartridge Operation 4-Hole 8" Installation With 1.5 GPM Flow Rate Side Spray Assembly	Chrome	12	\$83.50
		K-5150	Two Handle Kitchen Faucet ADA Wrist Blade Handles Spout Swivel 360° 7-9/16" Reach, 4-5/8" From Deck to Aerator Washerless Cartridge Operation 3-Hole 8" Installation With 1.5 GPM Flow Rate	Chrome	12	\$78.00
		K-5270	Two Handle Kitchen Faucet Lever Handles With White & Chrome Inserts High Arc Spout Swivel 360° 6-3/4" Reach, 9-13/16" From Deck to Aerator Washerless Cartridge Operation 3-Hole 8" Installation With 1.5 GPM Flow Rate	Chrome	12	\$80.50
		K-5271	Two Handle Kitchen Faucet Lever Handles With White & Chrome Inserts High Arc Spout Swivel 360° 6-3/4" Reach, 9-13/16" From Deck to Aerator Washerless Cartridge Operation 4-Hole 8" Installation With 1.5 GPM Flow Rate Side Spray Assembly	Chrome	12	\$90.50

See page 3 for special order finish options.

Olympia faucets feature aerators that meet ANSI/ASME A112.18.1 flow requirements of 1.5 GPM

ELITE // Two Handle Kitchen Faucets

TWO HANDLE KITCHEN FAUCETS

		Model#	Description	Finish	Case	Price
		K-5160	Two Handle Kitchen Faucet Lever Handles Spout Swivel 360° 7-9/16" Reach, 4-5/8" From Deck to Aerator Washerless Cartridge Operation 3-Hole 8" Installation With 1.5 GPM Flow Rate	Chrome	12	\$79.00
		K-5161	Two Handle Kitchen Faucet Lever Handles Spout Swivel 360° 7-9/16" Reach, 4-5/8" From Deck to Aerator Washerless Cartridge Operation 4-Hole 8" Installation With 1.5 GPM Flow Rate Side Spray Assembly	Chrome	12	\$89.00
		K-5170	Two Handle Kitchen Faucet Lever Handles Spout Swivel 360° 7-9/16" Reach, 4-5/8" From Deck to Aerator Washerless Cartridge Operation 3-Hole 8" Installation With 1.5 GPM Flow Rate	Chrome	12	\$84.00
		K-5171	Two Handle Kitchen Faucet Lever Handles Spout Swivel 360° 7-9/16" Reach, 4-5/8" From Deck to Aerator Washerless Cartridge Operation 4-Hole 8" Installation With 1.5 GPM Flow Rate Side Spray Assembly	Chrome	12	\$94.00

See page 3 for special order finish options.

Olympia faucets feature aerators that meet ANSI/ASME A112.18.1 flow requirements of 1.5 GPM

ELITE

KITCHEN // Two Handle Faucets

TWO HANDLE KITCHEN FAUCETS

	Model#	Description	Finish	Case	Price
PARTS	OP-190003C	Acrylic Round Handle-Cold	---	---	\$3.50
	OP-190003H	Acrylic Round Handle-Hot	---	---	\$3.50
	OP-190004C	Mini Blade Handle-Cold	Chrome	---	\$4.10
	OP-190004H	Mini Blade Handle-Hot	Chrome	---	\$4.10
	OP-190005C	ADA Wrist Blade Square Handle Set-Cold	Chrome	---	\$9.80
	OP-190005H	ADA Wrist Blade Square Handle Set-Hot	Chrome	---	\$9.80
	OP-190006C	Handle Hub-Cold	Chrome	---	\$9.80
	OP-190006H	Handle Hub-Hot	Chrome	---	\$9.80
	OP-190010C	Lever Handle-Cold	Chrome	---	\$13.30
	OP-190010H	Lever Handle-Hot	Chrome	---	\$13.30
	OP-190015C	Lever Handle-Cold	Chrome	---	\$14.30
	OP-190015H	Lever Handle-Hot	Chrome	---	\$14.30
	OP-220002	D Style Spout	Chrome	---	\$31.70
	OP-220003	High Arc Spout	Chrome	---	\$43.40
	OP-390004	Stem Unit-Brass Post	---	---	\$4.60
	OP-390005	Stem Unit-Plastic Post	---	---	\$4.60
	OP-420018	D Style Spout Cap and Packing	Chrome	---	\$3.50
	OP-420019	D Style Spout O-Ring	---	---	\$0.70
	OP-420020	D Style Spout Gasket	---	---	\$0.70
	OP-420021	High Arc Spout Bonnet Nut	---	---	\$4.10
	OP-420024	Diverter Piston	---	---	\$5.30
	OP-420025	Deck Plate	Chrome	---	\$12.30
	OP-420026	Mounting Gasket	---	---	\$1.20
	OP-420051	Hose and Spray Assembly	Black	---	\$23.00
	OP-490012C	Acrylic Handle Button-Cold	---	---	\$1.20
	OP-490012H	Acrylic Handle Button-Hot	---	---	\$1.20
	OP-490013C	Mini Blade Handle Button-Cold	---	---	\$1.20
	OP-490013H	Mini Blade Handle Button-Hot	---	---	\$1.20
	OP-490014	Handle Screw	---	---	\$0.70
	OP-490015	ADA Wrist Blade Square Handle Screw	---	---	\$0.70
	OP-490016C	ADA Wrist Blade Square Handle Index-Cold	---	---	\$0.70
	OP-490016H	ADA Wrist Blade Square Handle Index-Hot	---	---	\$0.70
	OP-490017	Lever Handle Insert-Chrome	Chrome	---	\$6.50

KITCHEN // Two Handle Faucets

















TWO HANDLE KITCHEN FAUCETS

	Model#	Description	Finish	Case	Price
PARTS	OP-490018	Lever Handle Insert-White	---	---	\$3.00
	OP-490029	Handle Set Screw	---	---	\$0.70
	OP-490035	Aerator-1.5 GPM	Chrome	---	\$6.90
	OP-490038	Snap Ring	---	---	\$0.70
	OP-490039	Spout O-Ring	---	---	\$0.70
	OP-490040	Bonnet Nut	---	---	\$2.40
	OP-490041	Springs and Seats	---	---	\$1.20
	OP-490042	Bell Hub Lever Handle Screw	---	---	\$1.20
	OP-520009	Mounting Hardware	---	---	\$3.40
	OP-590001	Brass Supply Nut	---	---	\$1.20
	OP-490010	Aerator-1.5 GPM	Chrome	---	\$5.70
	OP-490058	Aerator-1.0 GPM	Chrome	---	\$8.80
	OP-490059	Aerator-0.5 GPM	Chrome	---	\$8.80
	OP-490056	Aerator-1.0 GPM	Chrome	---	\$9.90
	OP-490055	Aerator-0.5 GPM	Chrome	---	\$8.80

Olympia faucets feature aerators that meet ANSI/ASME A112.18.1 flow requirements of 1.5 GPM

ELITE // Two Handle Bar/Laundry Faucets

TWO HANDLE BAR / LAUNDRY FAUCETS



		Model#	Description	Finish	Case	Price
	  	B-8170	Two Handle Bar Faucet ADA Wrist Blade Handles Gooseneck Spout Swivel 360° 5-1/4" Reach, 5-5/8" From Deck to Aerator Washerless Cartridge Operation 2 or 3-Hole 4" Installation With 1.5 GPM Flow Rate	Chrome	12	\$75.50
	  	B-8171	Two Handle Bar Faucet Mini Blade Handles Gooseneck Spout Swivel 360° 5-1/4" Reach, 5-5/8" From Deck to Aerator Washerless Cartridge Operation 2 or 3-Hole 4" Installation With 1.5 GPM Flow Rate	Chrome	12	\$63.50
	  	B-8180	Two Handle Bar Faucet ADA Wrist Blade Handles Gooseneck Spout Swivel 360° 3-9/16" Reach, 6-15/16" From Deck to Aerator Washerless Cartridge Operation 2 or 3-Hole 4" Installation With 1.5 GPM Flow Rate	Chrome	12	\$82.00
	  	B-8181	Two Handle Bar Faucet Mini Blade Handles Gooseneck Spout Swivel 360° 3-9/16" Reach, 6-15/16" From Deck to Aerator Washerless Cartridge Operation 2 or 3-Hole 4" Installation With 1.5 GPM Flow Rate	Chrome	12	\$70.00

See page 3 for special order finish options.

Olympia faucets feature aerators that meet ANSI/ASME A112.18.1 flow requirements of 1.5 GPM

ELITE // Two Handle Bar/Laundry Faucets

TWO HANDLE BAR / LAUNDRY FAUCETS





	Model#	Description	Finish	Case	Price
	B-8190	Two Handle Laundry Faucet ADA Wrist Blade Handles Hi-Tubular Spout Swivel 360° 5-1/2" Reach, 5-13/16" From Deck to Aerator Washerless Cartridge Operation 2 or 3-Hole 4" Installation With 1.5 GPM Flow Rate	Chrome	12	\$76.50
	B-8191	Two Handle Laundry Faucet Mini Blade Handles Hi-Tubular Spout Swivel 360° 5-1/2" Reach, 5-13/16" From Deck to Aerator Washerless Cartridge Operation 2 or 3-Hole 4" Installation With 1.5 GPM Flow Rate	Chrome	12	\$64.50
PARTS	OP-190004C	Mini Blade Handle-Cold	Chrome	---	\$4.10
	OP-190004H	Mini Blade Handle-Hot	Chrome	---	\$4.10
	OP-190014C	ADA Wrist Blade Handle-Cold	Chrome	---	\$13.30
	OP-190014H	ADA Wrist Blade Handle-Hot	Chrome	---	\$13.30
	OP-250004	8-15/16" High Spout	Chrome	---	\$30.10
	OP-250005	9-7/8" High Gooseneck Spout	Chrome	---	\$27.10
	OP-250007	7-9/16" Hi Tubular Spout	Chrome	---	\$28.60
	OP-390004	Stem Unit-Brass Post	---	---	\$4.60
	OP-390005	Stem Unit-Plastic Post	---	---	\$4.60
	OP-450010	Spout Bonnet Nut	Chrome	---	\$8.70
	OP-450011	Deck Plate	Chrome	---	\$11.00
	OP-450012	Mounting Gasket	---	---	\$1.20
	OP-450013	ADA Wrist Blade Handle Screw	---	---	\$0.70
	OP-450014	Hose Thread Adapter	Chrome	---	\$2.40
	OP-490001C	ADA Wrist Blade Handle Index-Cold	---	---	\$1.20
	OP-490001H	ADA Wrist Blade Handle Index-Hot	---	---	\$1.20
	OP-490013C	Mini Blade Handle Button-Cold	---	---	\$1.20
	OP-490013H	Mini Blade Handle Button-Hot	---	---	\$1.20
	OP-490014	Handle Screw	---	---	\$0.70
	OP-490038	Snap Ring	---	---	\$0.70
	OP-490039	Spout O-Ring	---	---	\$0.70
	OP-490040	Bonnet Nut	---	---	\$2.40
	OP-490041	Springs and Seats	---	---	\$1.20
	OP-590001	Brass Supply Nut	---	---	\$1.20
	OP-590003	Mounting Hardware	---	---	\$2.40
	OP-490035	Aerator-1.5 GPM	Chrome	---	\$6.90
OP-490056	Aerator-1.0 GPM	Chrome	---	\$9.90	
OP-490055	Aerator-0.5 GPM	Chrome	---	\$8.80	

See page 3 for special order finish options.

Olympia faucets feature aerators that meet ANSI/ASME A112.18.1 flow requirements of 1.5 GPM

ELITE // Single Handle Lavatory Faucets

SINGLE HANDLE LAVATORY FAUCETS



	Model#	Description	Finish	Case	Price
	L-6160	Single Handle Lavatory Faucet Metal Lever Handle	Chrome	12	\$75.00
	L-6160-BN	3-7/8" Reach, 1-3/4" From Deck to Aerator	PVD Brushed Nickel	12	\$95.00
	L-6160-ORB	Stainless Steel Ball Operation 3-Hole 4" Installation	Oil Rubbed Bronze	12	\$106.50
	L-6160B*	With 1.2 GPM Flow Rate	Chrome	12	\$73.00
	L-6160B-BN*	50/50 Pop-Up Drain Assembly *Builder Tract Pack	PVD Brushed Nickel	12	\$93.00
	L-6160H**	**Easy-Install 18" Flex Supply Lines With 3/8" Connections	Chrome	12	\$76.00
	L-6160H-BN**		Chrome	12	\$100.00
	L-6160-E0.5	With 0.5 GPM Flow Rate	Chrome	12	\$77.00
	L-6160B-E0.5		Chrome	12	\$75.00
	L-6160B-E1.0	With 1.0 GPM Flow Rate	Chrome	12	\$76.00
	L-6161	Single Handle Lavatory Faucet Metal Lever Handle	Chrome	12	\$66.00
	L-6161H*	3-7/8" Reach, 1-3/4" From Deck to Aerator Stainless Steel Ball Operation 3-Hole 4" Installation With 1.2 GPM Flow Rate *Easy-Install 18" Flex Supply Lines With 3/8" Connections	Chrome	12	\$67.00
	L-6161-E0.5	With 0.5 GPM Flow Rate	Chrome	12	\$68.00
	L-6161-E1.0	With 1.0 GPM Flow Rate	Chrome	12	\$68.00
	L-6164	With Pop-Up Hole Cover	Chrome	12	\$65.00
	L-6161G	Single Handle Lavatory Faucet Metal Lever Handle 3-7/8" Reach, 1-3/4" From Deck to Aerator Stainless Steel Ball Operation 3-Hole 4" Installation With 1.2 GPM Flow Rate Brass Grid Strainer Drain Assembly	Chrome	12	\$81.00
	L-6161G-E0.5	With 0.5 GPM Flow Rate	Chrome	12	\$84.00
	L-6162	Single Handle Lavatory Faucet Metal Lever Handle	Chrome	12	\$80.00
	L-6162-BN	3-7/8" Reach, 1-3/4" From Deck to Aerator	PVD Brushed Nickel	12	\$106.50
	L-6162B*	Stainless Steel Ball Operation 3-Hole 4" Installation	Chrome	12	\$78.00
	L-6162H**	With 1.2 GPM Flow Rate Brass Pop-Up Drain Assembly *Builder Tract Pack **Easy-Install 18" Flex Supply Lines With 3/8" Connections	Chrome	12	\$81.00
	L-6162-E0.5	With 0.5 GPM Flow Rate	Chrome	12	\$82.00
	L-6162-E1.0	With 1.0 GPM Flow Rate	Chrome	12	\$82.00
	L-6162B-E0.5	With 0.5 GPM Flow Rate	Chrome	12	\$81.00
	L-6162B-E1.0	With 1.0 GPM Flow Rate	Chrome	12	\$81.00
	L-6162H-E0.5	With 0.5 GPM Flow Rate	Chrome	12	\$86.00
	L-6162H-E1.0	With 1.0 GPM Flow Rate	Chrome	12	\$84.00

Builder Tract Packs sold in case quantities only.
See page 3 for special order finish options.

Olympia faucets feature aerators that meet ANSI/ASME A112.18.1 flow requirements of 1.5 GPM

ELITE // Single Handle Lavatory Faucets

SINGLE HANDLE LAVATORY FAUCETS













	Model#	Description	Finish	Case	Price
	L-6174	Single Handle Lavatory Faucet Metal Loop Handle 3-7/8" Reach, 1-3/4" From Deck to Aerator Stainless Steel Ball Operation 3-Hole 4" Installation With 1.2 GPM Flow Rate With Pop-up Hole Cover	Chrome	12	\$65.00
	L-6172	Single Handle Lavatory Faucet Metal Loop Handle 3-7/8" Reach, 1-3/4" From Deck to Aerator Stainless Steel Ball Operation 3-Hole 4" Installation With 1.2 GPM Flow Rate Brass Pop-Up Drain Assembly	Chrome	12	\$80.00
	L-6172-BN		PVD Brushed Nickel	12	\$106.50
	L-6170	Single Handle Lavatory Faucet Metal Loop Handle 3-7/8" Reach, 1-3/4" From Deck to Aerator Stainless Steel Ball Operation 3-Hole 4" Installation With 1.2 GPM Flow Rate 50/50 Pop-Up Drain Assembly	Chrome	12	\$75.00
	L-6170B*	*Builder Tract Pack	Chrome	12	\$73.00
PARTS	OP-190001	Metal Lever Handle	Chrome	---	\$13.30
	OP-190002	Metal Loop Handle	Chrome	---	\$13.30
	OP-390001	Stainless Steel Ball	---	---	\$3.50
	OP-430010	Lift Rod Hole Cover Button	Chrome	---	\$1.10
	OP-490002	Lever Handle Index Button	---	---	\$0.70
	OP-490003	Cap and Adjusting Ring	Chrome	---	\$7.00
	OP-490004	Cam and Washer	---	---	\$4.60
	OP-490041	Springs and Seats	---	---	\$1.20
	OP-490043	Lever Handle Allen Screw 1/8"	---	---	\$0.70
	OP-530001	Mounting Hardware	---	---	\$3.00
	OP-590001	Brass Supply Nut	---	---	\$1.20
	OP-630001	Brass Grid Strainer Drain Assembly	Chrome	---	\$27.60
	OP-630002	Brass Pop-Up Drain Assembly	Chrome	---	\$27.10
	OP-630004	50/50 Pop-Up Drain Assembly	Chrome	---	\$22.00
	OP-490035	Aerator-1.5 GPM	Chrome	---	\$6.90
	OP-490056	Aerator-1.0 GPM	Chrome	---	\$9.90
	OP-490055	Aerator-0.5 GPM	Chrome	---	\$8.80

See page 3 for special order finish options.

Olympia faucets feature aerators that meet ANSI/ASME A112.18.1 flow requirements of 1.5 GPM

ELITE // Two Handle Lavatory Faucets

TWO HANDLE LAVATORY FAUCETS



		Model#	Description	Finish	Case	Price
		L-7220	Two Handle Lavatory Faucet Acrylic Round Handles 3-5/8" Reach, 1-1/2" From Deck to Aerator Washerless Cartridge Operation 3-Hole 4" Installation With 1.2 GPM Flow Rate 50/50 Pop-Up Drain Assembly	Chrome	12	\$56.50
		L-7221	Two Handle Lavatory Faucet Acrylic Round Handles 3-5/8" Reach, 1-1/2" From Deck to Aerator Washerless Cartridge Operation 3-Hole 4" Installation With 1.2 GPM Flow Rate	Chrome	12	\$46.50
		L-7222	Two Handle Lavatory Faucet Acrylic Round Handles 3-5/8" Reach, 1-1/2" From Deck to Aerator Washerless Cartridge Operation 3-Hole 4" Installation With 1.2 GPM Flow Rate Brass Pop-Up Drain Assembly	Chrome	12	\$66.50
		L-7290	Two Handle Lavatory Faucet Mini Blade Handles 3-5/8" Reach, 1-1/2" From Deck to Aerator Washerless Cartridge Operation 3-Hole 4" Installation With 1.2 GPM Flow Rate 50/50 Pop-Up Drain Assembly	Chrome	12	\$60.00
		L-7291	Two Handle Lavatory Faucet Mini Blade Handles 3-5/8" Reach, 1-1/2" From Deck to Aerator Washerless Cartridge Operation 3-Hole 4" Installation With 1.2 GPM Flow Rate	Chrome	12	\$50.00
		L-7292	Two Handle Lavatory Faucet Mini Blade Handles 3-5/8" Reach, 1-1/2" From Deck to Aerator Washerless Cartridge Operation 3-Hole 4" Installation With 1.2 GPM Flow Rate Brass Pop-Up Drain Assembly	Chrome	12	\$69.00

Builder Tract Packs sold in case quantities only.
See page 3 for special order finish options.

Olympia faucets feature aerators that meet ANSI/ASME A112.18.1 flow requirements of 1.5 GPM

ELITE // Two Handle Lavatory Faucets

TWO HANDLE LAVATORY FAUCETS









	Model#	Description	Finish	Case	Price
	L-7251	Two Handle Lavatory Faucet ADA Wrist Blade Handles 3-5/8" Reach, 1-1/2" From Deck to Aerator Washerless Cartridge Operation 3-Hole 4" Installation With 1.2 GPM Flow Rate	Chrome	12	\$62.50
	L-7251-E0.5	With 0.5 GPM Flow Rate	Chrome	12	\$65.50
	L-7251G	Two Handle Lavatory Faucet ADA Wrist Blade Handles 3-5/8" Reach, 1-1/2" From Deck to Aerator Washerless Cartridge Operation 3-Hole 4" Installation With 1.2 GPM Flow Rate Brass Grid Strainer Drain Assembly	Chrome	12	\$77.50
PARTS	OP-190003C	Acrylic Round Handle-Cold	---	---	\$3.50
	OP-190003H	Acrylic Round Handle-Hot	---	---	\$3.50
	OP-190004C	Mini Blade Handle-Cold	Chrome	---	\$4.10
	OP-190004H	Mini Blade Handle-Hot	Chrome	---	\$4.10
	OP-190005C	ADA Wrist Blade Square Handle Set-Cold	Chrome	---	\$9.80
	OP-190005H	ADA Wrist Blade Square Handle Set-Hot	Chrome	---	\$9.80
	OP-390004	Stem Unit-Brass Post	---	---	\$4.60
	OP-390005	Stem Unit-Plastic Post	---	---	\$4.60
	OP-430005	Lift Rod Hole Cover Button	Chrome	---	\$0.70
	OP-490012C	Acrylic Handle Button-Cold	---	---	\$1.20
	OP-490012H	Acrylic Handle Button-Hot	---	---	\$1.20
	OP-490013C	Mini Blade Handle Button-Cold	---	---	\$1.20
	OP-490013H	Mini Blade Handle Button-Hot	---	---	\$1.20
	OP-490014	Handle Screw	---	---	\$0.70
	OP-490015	ADA Wrist Blade Square Handle Screw	---	---	\$0.70
	OP-490016C	ADA Wrist Blade Square Handle Index-Cold	---	---	\$0.70
	OP-490016H	ADA Wrist Blade Square Handle Index-Hot	---	---	\$0.70
	OP-490040	Bonnet Nut	---	---	\$2.40
	OP-490041	Springs and Seats	---	---	\$1.20
	OP-590001	Brass Supply Nut	---	---	\$1.20
	OP-590003	Mounting Hardware	---	---	\$2.40
	OP-630001	Brass Grid Strainer Drain Assembly	Chrome	---	\$27.60
	OP-630002	Brass Pop-Up Drain Assembly	Chrome	---	\$27.10
	OP-630004	50/50 Pop-Up Drain Assembly	Chrome	---	\$22.00
	OP-490035	Aerator-1.5 GPM	Chrome	---	\$6.90
	OP-490056	Aerator-1.0 GPM	Chrome	---	\$9.90
	OP-490055	Aerator-0.5 GPM	Chrome	---	\$8.80

See page 3 for special order finish options.

Olympia faucets feature aerators that meet ANSI/ASME A112.18.1 flow requirements of 1.5 GPM

ELITE // Pressure Balance Trim Sets

PRESSURE BALANCE TRIM SETS



	Model#	Description	Finish	Case	Price
	 P-2300T	Single Handle Tub/Shower Trim Set Metal Lever Handle	Chrome	12	\$60.50
	 P-2300T-BN	Face Plate	PVD Brushed Nickel	12	\$93.00
	P-2300T-ORB	Single Function 2-1/4" Standard Showerhead, Arm & Flange	Oil Rubbed Bronze	12	\$107.00
	P-2300T-MZ	Combo 1/2" IPS/Slip-On Diverter Tub Spout With 1.5 GPM Flow Rate For Use with P-2300B & P-2400B Series Valves - Valve not included	Moroccan Bronze	12	\$112.50
	P-2310T	Metal Loop Handle	Chrome	12	\$63.00
	P-2301T	Single Handle Tub Trim Set Metal Lever Handle	Chrome	12	\$44.50
	P-2301T-BN	Face Plate	PVD Brushed Nickel	12	\$77.00
	P-2301T-ORB	Combo 1/2" IPS/Slip-On Tub Spout Series Valves - Valve not included For Use with P-2300B & P-2400B	Oil Rubbed Bronze	12	\$88.00
	P-2302T	Single Handle Shower Trim Set Metal Lever Handle	Chrome	12	\$44.50
	P-2302T-BN	Face Plate	PVD Brushed Nickel	12	\$77.00
P-2302T-ORB	Single Function 2-1/4" Standard Showerhead, Arm & Flange With 1.5 GPM Flow Rate For Use with P-2300B & P-2400B Series Valves - Valve not included	Oil Rubbed Bronze	12	\$88.00	
P-2312T*	Metal Loop Handle	Chrome	12	\$47.00	
	 P-2303T	Single Handle Valve Trim Set Metal Lever Handle Face Plate	Chrome	12	\$27.50
	P-2303T-BN	For Use with P-2300B & P-2400B Series Valves - Valve not included	PVD Brushed Nickel	12	\$47.00
	P-2303T-ORB		Oil Rubbed Bronze	12	\$54.00
	 P-2306T	Single Handle Tub/Shower Trim Set Metal Lever Handle	Chrome	12	\$76.50
	 P-2306T-BN	Face Plate Four Function 3-3/8" Showerhead, Arm & Flange Combo 1/2" IPS/Slip-On Diverter Tub Spout With 1.75 GPM Flow Rate For Use with P-2300B & P-2400B Series Valves - Valve not included	PVD Brushed Nickel	12	\$125.00
	P-2307T	Single Handle Shower Trim Set Metal Lever Handle	Chrome	12	\$61.50
	P-2307T-BN	Face Plate Four Function 3-3/8" Showerhead, Arm & Flange With 1.75 GPM Flow Rate For Use with P-2300B & P-2400B Series Valves - Valve not included	PVD Brushed Nickel	12	\$110.00

Low flow showerheads available upon request.
See page 3 for special order finish options.

Olympia showerheads meet ANSI/ASME A112.18.1 flow requirements of maximum 1.75 GPM

ELITE // Pressure Balance Trim Sets

PRESSURE BALANCE TRIM SETS

	Model#	Description	Finish	Case	Price
	P-2300T-ADA	Single Handle Tub/Shower Trim Set with Diverter and Handheld Showerhead Single Function 2-1/4" Standard Showerhead-1.5 GPM Shower Arm & Flange Brass Diverter Valve Assembly - Diverter Valve Included Metal Lever Handles Face Plate For Use with P-2300B & P-2240B Series Valves - Valves not included Combo 1/2" IPS/Slip-On Diverter Tub Spout Five Functions Handheld Showerhead W/Non-Positive Shut Off-1.5 GPM 24" Slide Bar with Brass Mounts 60" Stainless Steel Flex Hose Brass Drop Ell with Vacuum Breaker	Chrome	4	\$273.50
	P-2302T-ADA	Less Diverter Tub Spout	Chrome	4	\$257.50
	P-2303T-ADA	Single Handle Valve Trim Set W/Handheld Shower Metal Lever Handle Face Plate For Use with P-2300B & P-2400B Series Valves - Valve not included Five Functions Handheld Showerhead W/Non-Positive Shut Off-1.5 GPM 24" Slide Bar with Brass Mounts 60" Stainless Steel Flex Hose Brass Drop Ell with Vacuum Breaker	Chrome	4	\$187.00
PARTS	OP-140008	Lever Handle	Chrome	---	\$17.90
	OP-140014	Metal Lever Handle	Chrome	---	\$16.90
	OP-140015	Lever Handle	Chrome	---	\$21.00
	OP-440054	Valve Sleeve	Chrome	---	\$6.00
	OP-440009	Face Plate Set	Chrome	---	\$20.40
	OP-440010	Face Plate Screw	Chrome	---	\$3.00
	OP-440011	Face Plate Rubber Gasket	---	---	\$2.40
	OP-440033	Adapter	---	---	\$4.10
	OP-640001	Shower Arm Flange	Chrome	---	\$1.20
	OP-640002	6" Shower Arm	Chrome	---	\$11.00
	OP-640027	Single Function Standard Showerhead	Chrome	---	\$21.00
	OP-640029	Three Functions Pulsating Showerhead	Chrome	---	\$25.50
	OP-640018	Combo Diverter Tub Spout	Chrome	---	\$19.90
	OP-660005	Handheld Shower	Chrome	---	\$43.00
	OP-460001	Handle Adapter	---	---	\$3.00

Low flow showerheads available upon request.
See page 3 for special order finish options.

Olympia showerheads meet ANSI/ASME A112.18.1 flow requirements of maximum 1.75 GPM

ELITE // Pressure Balance Trim Sets

PRESSURE BALANCE TUB / COMPLETE SHOWER SETS



	Model#	Description	Finish	Case	Price
PARTS	OP-640019	Combo Tub Spout	Chrome	---	\$13.30
	OP-640020	8" Shower Arm	Chrome	---	\$13.00
	OP-640022	Three Functions Pulsating Showerhead	Chrome	---	\$21.50
	OP-640024	Single Function Standard Showerhead	Chrome	---	\$16.90
	OP-640035	Four Functions Showerhead	Chrome	---	\$33.70
	OP-440009	Face Plate Set	Chrome	---	\$20.40
	OP-440010	Face Plate Screw	Chrome	---	\$3.00
	OP-440011	Face Plate Rubber Gasket	---	---	\$2.40
	OP-490011	Allen Wrench 3/32"	---	---	\$0.70
	OP-640001	Shower Arm Flange	Chrome	---	\$1.20
	OP-640002	6" Shower Arm	Chrome	---	\$11.00
	OP-640027	Single Function Standard Showerhead	Chrome	---	\$21.00
	OP-640018	Combo Diverter Tub Spout	Chrome	---	\$19.90
	OP-640019	Combo Tub Spout	Chrome	---	\$13.30
	OP-640020	8" Shower Arm	Chrome	---	\$13.00
	OP-640024	Single Function Standard Showerhead	Chrome	---	\$16.90
	OP-460005	Diverter Sleeve	Chrome	---	\$9.40
	OP-460002	Flange	Chrome	---	\$13.30
	OP-140009	Lever Handle	Chrome	---	\$10.40
	OP-560001	Mounting Kit	---	---	\$1.80
	OP-460011	Mounting Screw	---	---	\$1.10
	OP-490029	Allen Screw	---	---	\$0.70
	OP-460010	Slide Bar	Chrome	---	\$83.20

Low flow showerheads available upon request.

Olympia showerheads meet ANSI/ASME A112.18.1 flow requirements of maximum 1.75 GPM

ELITE // Single Handle Shower Sets

SINGLE HANDLE TUB / SHOWER SETS

	Model#	Description	Finish	Case	Price
		P-2000 Single Handle Tub/Shower Set Metal Lever Handle Face Plate 1/2" IPS Female Inlets Stainless Steel Ball Operation Single Function 1-3/4" Showerhead, Arm & Flange 1/2" IPS Diverter Tub Spout With 2.5 GPM Flow Rate Non-Pressure Balance Valve Included	Chrome	12	\$76.00
		P-2002 Single Handle Shower Set Metal Lever Handle Face Plate 1/2" IPS Female Inlets Stainless Steel Ball Operation Single Function 1-3/4" Showerhead, Arm & Flange With 2.5 GPM Flow Rate Non-Pressure Balance Valve Included	Chrome	12	\$72.50
		P-2002-BN Single Handle Shower Set Metal Lever Handle Face Plate 1/2" IPS Female Inlets Stainless Steel Ball Operation Single Function 1-3/4" Showerhead, Arm & Flange With 2.5 GPM Flow Rate Non-Pressure Balance Valve Included	PVD Brushed Nickel	12	\$115.50
PARTS	OP-140006	Metal Lever Handle	Chrome	---	\$9.80
	OP-390001	Stainless Steel Ball	---	---	\$3.50
	OP-440018	Face Plate Set	Chrome	---	\$21.00
	OP-440019	Face Plate Screw	Chrome	---	\$2.40
	OP-440020	Valve Plug	---	---	\$3.00
	OP-490003	Cap and Adjusting Ring	Chrome	---	\$7.00
	OP-490004	Cam and Washer	---	---	\$4.60
	OP-490036	Allen Wrench 1/8"	---	---	\$0.70
	OP-490041	Springs and Seats	---	---	\$1.20
	OP-640001	Shower Arm Flange	Chrome	---	\$1.20
	OP-640002	6" Shower Arm	Chrome	---	\$11.00
	OP-640005	Single Function Standard Showerhead	Chrome	---	\$5.90
	OP-640014	1/2" IPS Tub Spout	Chrome	---	\$9.90
	OP-640015	1/2" IPS Diverter Tub Spout	Chrome	---	\$15.70



This is not a pressure balance valve. It may not meet local code.
 See page 3 for special order finish options.

Olympia showerheads meet ANSI/ASME A112.18.1 flow requirements of maximum 2.5 GPM

ELITE

ELITE // Two Handle Shower Sets

TWO & THREE HANDLE TUB / SHOWER SETS



	Model#	Description	Finish	Case	Price
	P-1220	Two Handle Tub/Shower Set Acrylic Round Handles Built-in Transfer Valve 1/2" IPS Female Inlets Compression Stem Operation Single Function 1-3/4" Showerhead, Arm & Flange 1/2" IPS Diverter Tub Spout With 2.5 GPM Flow Rate 8" Cast Brass Valve body Included	Chrome	12	\$81.50
	P-1222	Two Handle Shower Set Acrylic Round Handles Built-in Transfer Valve 1/2" IPS Female Inlets Compression Stem Operation Single Function 1-3/4" Showerhead, Arm & Flange With 2.5 GPM Flow Rate 8" Cast Brass Valve body Included	Chrome	12	\$78.00
	P-1210	Two Handle Tub/Shower Set Metal Round Handles Built-in Transfer Valve 1/2" IPS Female Inlets Compression Stem Operation Single Function 1-3/4" Showerhead, Arm & Flange 1/2" IPS Diverter Tub Spout With 2.5 GPM Flow Rate 8" Cast Brass Valve body Included	Chrome	12	\$84.00
	P-1212	Two Handle Shower Set Metal Round Handles Built-in Transfer Valve 1/2" IPS Female Inlets Compression Stem Operation Single Function 1-3/4" Showerhead, Arm & Flange With 2.5 GPM Flow Rate 8" Cast Brass Valve body Included	Chrome	12	\$80.50
	P-1230	Two Handle Tub/Shower Set Lever Handles Built-in Transfer Valve 1/2" IPS Female Inlets Washerless Cartridge Operation Single Function 2-1/4" Standard Showerhead, Arm & Flange With 1.5 GPM Flow Rate 1/2" IPS Diverter Tub Spout 8" Cast Brass Valve body Included	Chrome	12	\$121.00
	P-1230-BN		PVD Brushed Nickel	12	\$159.00
	P-1232	Two Handle Shower Set Lever Handles Built-in Transfer Valve 1/2" IPS Female Inlets Washerless Cartridge Operation Single Function 2-1/4" Standard Showerhead, Arm & Flange With 1.5 GPM Flow Rate 8" Cast Brass Valve body Included	Chrome	12	\$108.00
	P-1232-BN		PVD Brushed Nickel	12	\$136.50

This is not a pressure balance valve. It may not meet local code. See page 3 for special order finish options.

Olympia showerheads meet ANSI/ASME A112.18.1 flow requirements of maximum 2.5 GPM

ELITE // Three Handle Shower Sets

TWO & THREE HANDLE TUB / SHOWER SETS

	Model#	Description	Finish	Case	Price
	P-3230	Three Handle Tub/Shower Set Lever Handles	Chrome	6	\$144.00
	P-3230-BN	1/2" IPS Female Inlets Washerless Cartridge Operation Single Function 2-1/4" Standard Showerhead, Arm & Flange With 1.5 GPM Flow Rate 1/2" IPS Tub Spout 8" Cast Brass Valve body Included	PVD Brushed Nickel	6	\$192.00
	P-3210	Three Handle Tub/Shower Set Metal Round Handles 1/2" IPS Female Inlets Compression Stem Operation Single Function 1-3/4" Showerhead, Arm & Flange 1/2" IPS Tub Spout With 2.5 GPM Flow Rate 8" Cast Brass Valve body Included	Chrome	12	\$113.00
	P-3220	Three Handle Tub/Shower Set Acrylic Round Handles 1/2" IPS Female Inlets Compression Stem Operation Single Function 1-3/4" Showerhead, Arm & Flange 1/2" IPS Tub Spout With 2.5 GPM Flow Rate 8" Cast Brass Valve body Included	Chrome	12	\$110.50

This is not a pressure balance valve. It may not meet local code
See page 3 for special order finish options.

Olympia showerheads meet ANSI/ASME A112.18.1 flow requirements of maximum 2.5 GPM

ELITE

ELITE // Two/Three Handle Shower Sets

TWO & THREE HANDLE TUB / SHOWER SETS

	Model#	Description	Finish	Case	Price
PARTS	OP-140004V	Large Metal Round Handle Set-Diverter	Chrome	---	\$9.80
	OP-140005V	Large Acrylic Round Handle Set-Diverter	---	---	\$5.90
	OP-190009C	Large Acrylic Round Handle-Cold	---	---	\$5.90
	OP-190009H	Large Acrylic Round Handle-Hot	---	---	\$5.90
	OP-190013C	Large Metal Round Handle-Cold	Chrome	---	\$9.80
	OP-190013H	Large Metal Round Handle-Hot	Chrome	---	\$9.80
	OP-340001	Stem Set	---	---	\$15.60
	OP-340002	Diverter Stem Set	---	---	\$13.80
	OP-440008	Diverter Piston	---	---	\$0.70
	OP-440012	Valve Escutcheon	Chrome	---	\$4.60
	OP-440013	Plastic Nipple	---	---	\$0.70
	OP-440014	Shower Seat	---	---	\$1.70
	OP-440015	Tailpiece Union	---	---	\$4.10
	OP-440016	Tailpiece Locknut	---	---	\$4.60
	OP-440017	Mounting Mud Guard	---	---	\$1.10
	OP-490025	Large Acrylic Handle Screw	Chrome	---	\$1.20
	OP-640001	Shower Arm Flange	Chrome	---	\$1.20
	OP-640002	6" Shower Arm	Chrome	---	\$11.00
	OP-640005	Single Function Standard Showerhead	Chrome	---	\$5.90
	OP-640014	1/2" IPS Tub Spout	Chrome	---	\$9.90
	OP-640015	1/2" IPS Diverter Tub Spout	Chrome	---	\$15.70
	OP-140009	Lever Handle	Chrome	---	\$10.40
	OP-190015C	Lever Handle-Cold	Chrome	---	\$14.30
	OP-340006C	Cartridge Unit-Cold	---	---	\$4.10
	OP-340006H	Cartridge Unit-Hot	---	---	\$4.10
	OP-340007	Diverter Stem Unit	---	---	\$5.90
	OP-440034	Diverter Piston	---	---	\$1.80
	OP-440035	Stem Extension	---	---	\$3.50
	OP-440036	Sleeve	Chrome	---	\$11.60
	OP-440037	Flange	Chrome	---	\$6.50
	OP-490011	Allen Wrench 3/32"	---	---	\$0.70
	OP-490041	Springs and Seats	---	---	\$1.20
	OP-640003	Single Function Standard Showerhead	Chrome	---	\$15.90

This is not a pressure balance valve. It may not meet local code.

Olympia showerheads meet ANSI/ASME A112.18.1 flow requirements of maximum 2.5 GPM

TUB & SHOWER // Valves

ROMAN TUB SETS / VALVES





	Model#	Description	Finish	Case	Price
	P-1131B	Two Handle Roman Tub Valve Set 1/2" IPS Connections Quick Mount Connector Deck or Ledge Mount Ceramic Disc Cartridges 3-Hole 8" to 16" Installation Brass Plug 12" SS Flex Hose, Mud Guards Included	---	12	\$110.00
PARTS	OP-340004C	Ceramic Cartridge-Cold	---	---	\$11.60
	OP-340004H	Ceramic Cartridge-Hot	---	---	\$11.60
	OP-440025	Flex Hose Connector	---	---	\$18.90
	OP-440026	Tee Connector	---	---	\$11.60
	OP-490006	Bonnet Nut	---	---	\$5.30
	OP-540004	Valve Mounting Kit	---	---	\$8.90
	OP-540005	Shank Mounting Kit	---	---	\$9.20
	OP-540006	Shank	---	---	\$18.90

Single Handle Diverter Valve

	Model#	Description	Finish	Case	Price
	P-2240B	Single Handle Diverter Valve Two Way Diverter Valve Compression Stem Operation 1/2" IPS Connection	---	10	\$29.00

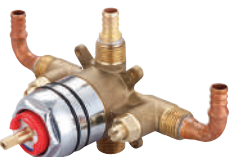
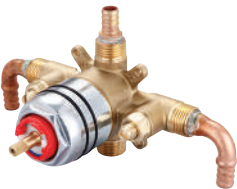
TUB & SHOWER // Valves





PRESSURE BALANCE VALVES

	Model#	Description	Finish	Case	Price
	P-2300B	Single Handle Tub/Shower Valve Combo CXC and IPS Inlet and Outlet Connections	Rough Brass	12	\$88.00
	P-2300B-B*	Pressure Balance Spool Included Brass Inlet Stops Ceramic Disc Cartridge With Temperature Limit Stop Back to Back Installation *Builder Tract Pack	Rough Brass	12	\$86.00
	P-2301B	Single Handle Tub/Shower Valve 1/2" PEX Inlet & Shower Outlet W/Combo CXC & IPS Tub Outlet	Rough Brass	12	\$104.00
	P-2301B-B*	Pressure Balance Spool Included Brass Inlet Stops Ceramic Disc Cartridge With Temperature Limit Stop Back to Back Installation *Builder Tract Pack	Rough Brass	12	\$102.00
	P-2302B	Single Handle Tub/Shower Valve 1/2" PEX Inlet & Shower Outlet W/Combo CXC & IPS Tub Outlet	Rough Brass	12	\$104.00
	P-2302B-B*	Pressure Balance Spool Included Brass Inlet Stops Ceramic Disc Cartridge With Temperature Limit Stop Back to Back Installation *Builder Tract Pack	Rough Brass	12	\$102.00
	P-2303B	Single Handle Tub and Shower Valve 1/2" CPVC Inlet W/Combo CXC & IPS Outlet	Rough Brass	12	\$98.00
	P-2303B-B*	Pressure Balance Spool Included Brass Inlet Stops Ceramic Disc Cartridge With Temperature Limit Stop Back to Back Installation *Builder Tract Pack	Rough Brass	12	\$96.00
	P-2304B	Single Handle Tub/Shower Valve 1/2" PEX Inlet & Shower Outlet W/Copper Stub Tub Outlet	Rough Brass	6	\$121.00
	P-2304B-B*	Pressure Balance Spool Included Brass Inlet Stops Ceramic Disc Cartridge With Temperature Limit Stop Back to Back Installation *Builder Tract Pack	Rough Brass	6	\$119.00
	P-2305B	Single Handle Tub and Shower Valve 1/2" PEX Inlet W/Combo CXC & IPS Outlet	Rough Brass	12	\$102.00
	P-2305B-B*	Pressure Balance Spool Included Brass Inlet Stops Ceramic Disc Cartridge With Temperature Limit Stop Back to Back Installation *Builder Tract Pack	Rough Brass	12	\$100.00

Builder Tract Packs sold in case quantities only.

TUB & SHOWER // Valves

PRESSURE BALANCE VALVES





	Model#	Description	Finish	Case	Price
	P-2306B	Single Handle Tub/Shower Valve 1/2" PEX Inlet & Shower Outlet W/Copper Stub Tub	Rough Brass	6	\$121.00
	P-2306B-B*	Outlet Pressure Balance Spool Included Brass Inlet Stops Ceramic Disc Cartridge With Temperature Limit Stop Back to Back Installation *Builder Tract Pack Note: Color Match Sleeve Ships with shower trim on All Valves	Rough Brass	6	\$119.00
	P-2307B	Single Handle Tub/Shower Valve 1/2" Uponor PEX Inlet W/Combo CXC & IPS Outlet	Rough Brass	12	\$107.00
	P-2307B-B*	Pressure Balance Spool Included Brass Inlet Stops Ceramic Disc Cartridge With Temperature Limit Stop Back to Back Installation *Builder Tract Pack	Rough Brass	12	\$105.00
	P-2308B	Single Handle Tub/Shower Valve 1/2" Uponor PEX Inlet & Shower Outlet	Rough Brass	12	\$109.00
	P-2308B-B*	W/Combo CXC & IPS Tub Outlet Pressure Balance Spool Included Brass Inlet Stops Ceramic Disc Cartridge With Temperature Limit Stop Back to Back Installation *Builder Tract Pack	Rough Brass	12	\$107.00
	P-2309B	Single Handle Tub/Shower Valve 1/2" Uponor PEX Inlet & Shower Outlet	Rough Brass	6	\$121.00
	P-2309B-B*	W/Copper Stub Tub Outlet Pressure Balance Spool Included Brass Inlet Stops Ceramic Disc Cartridge With Temperature Limit Stop Back to Back Installation *Builder Tract Pack	Rough Brass	6	\$119.00
	P-2311B	Single Handle Tub/Shower Valve 1/2" CPVC Inlet & Shower Outlet W/Combo CXC & IPS	Rough Brass	6	\$107.00
	P-2311B-B*	Tub Outlet Pressure Balance Spool Included Brass Inlet Stops Ceramic Disc Cartridge With Temperature Limit Cap Back to Back Installation	Rough Brass	6	\$105.00

Builder Tract Packs sold in case quantities only.

TUB & SHOWER



TUB & SHOWER // Valves

PRESSURE BALANCE VALVES

	Model#	Description	Finish	Case	Price
	P-2400B	Single Handle Tub and Shower Valve Combo CXC and IPS Inlet and Outlet Connections	Rough Brass	12	\$83.50
	P-2400B-B*	Pressure Balance Spool Included Ceramic Disc Cartridge With Temperature Limit Stop Back to Back Installation *Builder Tract Pack	Rough Brass	12	\$81.50
	P-2403B	Single Handle Tub/Shower Valve 1/2" CPVC Inlet W/Combo CXC & IPS Outlet	Rough Brass	12	\$90.50
	P-2403B-B*	Pressure Balance Spool Included Ceramic Disc Cartridge With Temperature Limit Stop Back to Back Installation *Builder Tract Pack	Rough Brass	12	\$88.50
	P-2405B	Single Handle Tub/Shower Valve 1/2" PEX Inlet W/Combo CXC & IPS Outlet	Rough Brass	12	\$96.50
	P-2405B-B*	Pressure Balance Spool Included Ceramic Disc Cartridge With Temperature Limit Stop Back to Back Installation *Builder Tract Pack	Rough Brass	12	\$94.50
	P-2407B	Single Handle Tub/Shower Valve 1/2" Uponor PEX Inlet W/Combo CXC & IPS Outlet	Rough Brass	12	\$102.50
	P-2407B-B*	Pressure Balance Spool Included Ceramic Disc Cartridge With Temperature Limit Stop Back to Back Installation *Builder Tract Pack	Rough Brass	12	\$100.50
	P-2408B	Single Handle Tub/Shower Valve 1/2" Uponor PEX Inlet & Shower Outlet W/Combo CXC & IPS Tub Outlet	Rough Brass	12	\$104.00
	P-2408B-B*	Pressure Balance Spool Included Ceramic Disc Cartridge With Temperature Limit Cap Back to Back Installation	Rough Brass	12	\$102.00
PARTS	OP-340009	Ceramic Cartridge W/Spring	---	---	\$39.30
	OP-440007	Inlet Supply Stop	---	---	\$9.20
	OP-440021	Valve Mud Guard	---	---	\$3.50
	OP-440053	Sleeve Nut	Chrome	---	\$5.00
	OP-440054	Sleeve			\$6.00
	OP-440023	Outlet Plastic Protection Cap	---	---	\$0.70
	OP-440024	Valve Mud Guard Screw	---	---	\$1.20
	OP-440044	Check Valve and Sleeve	Chrome	---	\$9.90
	OP-440045	Tub/Shower-1" Extension	---	---	\$41.90

ACCESSORIES // Lavatory Drains

LAVATORY DRAINS

	Model#	Description	Finish	Case	Price
	OP-630004	50/50 Pop-Up Drain Assembly For Use With Sinks With Overflow Drains	Chrome	---	\$22.00
	OP-630004-BN	1-1/2" 50/50 Pop-Up Drain	PVD Brushed Nickel	---	\$24.00
	OP-630004-ORB		Oil Rubbed Bronze	---	\$25.00
PARTS	OP-430016	Pop-Up Stopper	---	---	\$4.80
	OP-430017	Pop-Up Horizontal Rod Group	---	---	\$4.00
	OP-430018	Pop-Up Top Flange	---	---	\$4.80
	OP-430019	Pop-Up Bracket & Screw	---	---	\$1.70
	OP-530004	Pop-Up Mounting Kit	---	---	\$3.30
	OP-630002	Brass Pop-Up Drain Assembly For Use With Sinks With Overflow Drains	Chrome	---	\$27.10
	OP-630002-BN	1-1/2" All Brass Pop-Up Drain	PVD Brushed Nickel	---	\$29.60
	OP-630002-ORB		Oil Rubbed Bronze	---	\$30.60
PARTS	OP-430008	Pop-Up Stopper	---	---	\$2.50
	OP-430009	Pop-Up Horizontal Rod Group	---	---	\$2.50
	OP-430020	Pop-Up Bracket & Screw	---	---	\$1.70
	OP-530003	Pop-Up Mounting Kit	---	---	\$4.80
	OP-630001	Brass Grid Strainer Drain Assembly For Use With Sinks With Overflow Drains 1-1/2" All Brass Grid Drain	Chrome	---	\$27.60

ACCESSORIES

ACCESSORIES // Tub Spouts

TUB SPOUTS

	Model#	Description	Finish	Case	Price
	OP-640018	Combo Diverter Tub Spout Zinc Die Cast Construction	Chrome	---	\$19.90
	OP-640018-BN	5-1/4" Reach	PVD Brushed Nickel	---	\$26.00
	OP-640018-ORB	1/2" IPS or Slip-Fit Installation	Oil Rubbed Bronze	---	\$28.20
	OP-640019	Combo Tub Spout Zinc Die Cast Construction	Chrome	---	\$13.30
	OP-640019-BN	5-1/4" Reach	PVD Brushed Nickel	---	\$22.40
	OP-640019-ORB	1/2" IPS or Slip-Fit Installation	Oil Rubbed Bronze	---	\$24.30
	OP-640015	1/2" IPS Diverter Tub Spout Zinc Die Cast Construction	Chrome	---	\$15.70
	OP-640015-BN	5-1/4" Reach	PVD Brushed Nickel	---	\$21.50
	OP-640014	1/2" IPS Tub Spout Zinc Die Cast Construction	Chrome	---	\$9.90
	OP-640014-BN	5-1/4" Reach	PVD Brushed Nickel	---	\$16.40
	OP-640033	Extended Front Lift Diverter Tub Spout-Combo 1/2" IPS/ Slip-On Inlet	Chrome	---	\$40.80
	OP-640033-BN	Zinc Die Cast Construction 7" Reach 1/2" IPS or Slip-Fit Installation	PVD Brushed Nickel	---	\$56.70
	OP-640034	Extended Tub Spout-Combo 1/2" IPS/Slip-On Inlet Zinc Die Cast Construction	Chrome	---	\$33.70
	OP-640034-BN	7" Reach 1/2" IPS or Slip-Fit Installation	PVD Brushed Nickel	---	\$48.00
	OP-640040	Extended i2 Combo Diverter Tub Spout Zinc Die Cast Construction	Chrome	---	\$55.00
	OP-640040-BN	7" Reach 1/2" IPS or Slip-Fit Installation	PVD Brushed Nickel	---	\$69.50

ACCESSORIES // Showerheads

SHOWERHEADS

	Model#	Description	Finish	Case	Price
	 OP-640048	Single Function Standard Showerhead-1.5 GPM 2-11/16" Face	Chrome	---	\$21.00
	 OP-640053	Single Function Standard Showerhead-1.75 GPM 2-11/16" Face	Chrome	---	\$21.00
	OP-640022	Three Functions Pulsating Showerhead-1.50 GPM 3 Spray Patterns	Chrome	---	\$21.50
	OP-640022-BN	Brass Ball Swivel Joint	PVD Brushed Nickel	---	\$32.70
	OP-640022-ORB	2-1/2" Face	Oil Rubbed Bronze	---	\$35.70
	 OP-640029	Three Functions Pulsating Showerhead-1.75 GPM 3 Spray Patterns	Chrome	---	\$25.50
	 OP-640029-BN	Brass Ball Swivel Joint	PVD Brushed Nickel	---	\$36.80
	OP-640029-ORB	2-1/2" Face	Oil Rubbed Bronze	---	\$39.80
	OP-640005	Single Function Standard Showerhead-2.50 GPM Adjustable Flow	Chrome	---	\$5.90
	OP-640005-BN	1-3/4" Face	PVD Brushed Nickel	---	\$11.60
	 OP-640031	Single Function Standard Showerhead-1.75 GPM Adjustable Flow	Chrome	---	\$11.10
	 OP-640031-BN	1-3/4" Face	PVD Brushed Nickel	---	\$16.90
	 OP-640035	Four Functions Showerhead Rub-Clean Anti-Scale Spray	Chrome	---	\$33.70
	 OP-640035-BN	Brass Ball Swivel Joint	PVD Brushed Nickel	---	\$40.80
	OP-640035-ORB	3-3/8" Face 1.75 GPM @ 80 PSI	Oil Rubbed Bronze	---	\$43.90
	 OP-640038	Single Function Showerhead Rub-Clean Anti-Scale Spray Ball Swivel Joint	Chrome	---	\$30.00
	 OP-640039	3-3/4" Face 1.75 GPM @ 80 PSI	Chrome	---	\$31.00
	 OP-640041	Three Function Showerhead Rub-Clean Anti-Scale Spray Brass Ball Swivel Joint	Chrome	---	\$49.00
	 OP-640042	Single Function Square Showerhead Rub-Clean Anti-Scale Spray Brass Ball Swivel Joint	Chrome	---	\$52.00
	 OP-640047	Single Function Rain Showerhead 6" Face 1.75 GPM @ 80 PSI	Chrome	---	\$53.00





ACCESSORIES

Low flow showerheads available upon request.







ACCESSORIES // Strainers

STRAINERS

	Model#	Description	Finish	Case	Price
	ACS-300100	Stainless Steel Duo Basket Strainer Heavy Duty Design Fits all 3-1/2" or 4" Drain Opening Long Lasting Finish Removable Basket Strainer with Open/Close Stopper that Seals Tightly Post Type Strainer	Chrome	50	\$7.50
	ACS-300200	Stainless Steel Easy Connect Basket Strainer Heavy Duty Design Fits all 3-1/2" or 4" Drain Opening Long Lasting Finish Features Quick Locking Easy Installation System Post Type Strainer	Chrome	50	\$10.50
	ACS-300400	Stainless Steel Double Cup Basket Strainer Heavy Duty Design Fits all 3-1/2" or 4" Drain Opening Long Lasting Finish Removable Basket Strainer with Open/Close Stopper that Seals Tightly Post Type Strainer Features Long Shank for Extra Thick Deck	Chrome	50	\$13.00
	ACS-300500	Stainless Steel Spin & Seal Basket Strainer Heavy Duty Design Fits all 3-1/2" or 4" Drain Opening Long Lasting Finish Removable Basket Strainer with Open/Close Stopper that Seals Tightly Spin Type Strainer Features Spin & Seal Operation	Chrome	50	\$15.50

ACCESSORIES // Misc. Parts

MISC. PARTS

	Model#	Description	Finish	Case	Price
	ACS-903100	Dishwasher Air Gap Plastic Body Included	Chrome	96	\$7.50
	ACS-903100-BN	1-3/4" Cap Diameter 2-1/2" Cap Height	PVD Brushed Nickel	96	\$11.00
	ACS-903100-ORB	8-7/8" Overall Height With Plastic Body	Oil Rubbed Bronze	96	\$12.50
	ACS-903500	Soap/Lotion Dispenser Solid Brass	Chrome	25	\$24.00
	ACS-903500-BN	Heavy Metal Dispenser Plastic Bottle Includes Bottle and Dispenser Pump Dispenser Capacity 12 Oz. Fits 3/4" Thick Deck 1-1/2" Optional Extension available for Thicker Deck	PVD Brushed Nickel	25	\$33.00
PARTS	OP-420023	Shank Extension For Soap/Lotion Dispenser	---	---	\$8.40
	OP-640017	Renovation Face Plate Face Plate converts 2 or 3 Handle Shower to 1 Handle With no Tile Replacements	Chrome	---	\$63.80
	OP-640017-BN	Works with All Olympia Pressure Balance Valves	PVD Brushed Nickel	---	\$97.60
	OP-640017-ORB		Oil Rubbed Bronze	---	\$101.50
	OP-490045	Replacement Parts Kit Genuine Olympia Product's Repair Parts Includes OP-490046 (1 Pc), OP-340008 (1 Pc) OP-390004 (6 Pcs), OP-390005 (6 Pcs) OP-490019 (6 Pcs), OP-420001 (6 Pcs) OP-490026 (2 Pcs), OP-490027 (2 Pcs) OP-430006 (2 Pcs), OP-420005 (2 Pcs) OP-420024 (4 Pcs), OP-390001 (3 Pcs) OP-490004 (3 Pcs), OP-490041 (5 Pcs)	---	---	\$98.00

ACCESSORIES

ACCESSORIES // Aerators

AERATORS

Model#	Description	Finish	Case	Price
OP-490026	Aerator - Female 55/64" Thread 2.0 GPM Flow Rate	Chrome	---	\$1.80
OP-490035	Aerator - Female 55/64" Thread 1.5 GPM Flow Rate	Chrome	---	\$6.90
OP-490035-BN		PVD Brushed Nickel	---	\$8.00
OP-490035-ORB		Oil Rubbed Bronze	---	\$9.90
OP-490056	Aerator - Female 55/64" Thread 1.0 GPM Flow Rate	Chrome	---	\$9.90
OP-490056-BN		PVD Brushed Nickel	---	\$11.10
OP-490056-ORB		Oil Rubbed Bronze	---	\$12.60
OP-490055	Aerator - Female 55/64" Thread 0.5 GPM Flow Rate	Chrome	---	\$8.80
OP-490055-BN		PVD Brushed Nickel	---	\$9.90
OP-490055-ORB		Oil Rubbed Bronze	---	\$11.60
OP-490019	Aerator - Male 15/16" Thread 2.0 GPM Flow Rate	Chrome	---	\$2.70
OP-490010	Aerator - Male 15/16" Thread 1.5 GPM Flow Rate	Chrome	---	\$5.70
OP-490010-BN		PVD Brushed Nickel	---	\$7.00
OP-490010-ORB		Oil Rubbed Bronze	---	\$7.90
OP-490058	Aerator - Male 15/16" Thread 1.0 GPM Flow Rate	Chrome	---	\$8.80
OP-490058-BN		PVD Brushed Nickel	---	\$9.90
OP-490058-ORB		Oil Rubbed Bronze	---	\$11.60
OP-490059	Aerator - Male 15/16" Thread 0.5 GPM Flow Rate	Chrome	---	\$8.80
OP-490059-BN		PVD Brushed Nickel	---	\$9.90
OP-490059-ORB		Oil Rubbed Bronze	---	\$11.60
OP-490027	Aerator - Female 55/64" Thread 2.0 GPM Flow Rate	Chrome	---	\$3.00
OP-490057	Aerator - Female 55/64" Thread With 1.5 GPM Flow Rate	Chrome	---	\$8.80
OP-490057-BN		PVD Brushed Nickel	---	\$9.90
OP-490057-ORB		Oil Rubbed Bronze	---	\$11.10
OP-490060	Aerator - Female 55/64" Thread 1.0 GPM Flow Rate	Chrome	---	\$11.10
OP-490060-BN		PVD Brushed Nickel	---	\$12.10
OP-490060-ORB		Oil Rubbed Bronze	---	\$13.10
OP-490061	Aerator - Female 55/64" Thread 0.5 GPM Flow Rate	Chrome	---	\$11.10
OP-490061-BN		PVD Brushed Nickel	---	\$12.10
OP-490061-ORB		Oil Rubbed Bronze	---	\$13.10

ACCESSORIES // Aerators

AERATORS

Model#	Description	Finish	Case	Price
OP-430006	Aerator - Female 55/64" Thread 2.0 GPM Flow Rate	Chrome	---	\$5.30
OP-430007	Aerator - Female 55/64" Thread With 1.5 GPM Flow Rate	Chrome	---	\$7.50
OP-430007-BN		PVD Brushed Nickel	---	\$9.90
OP-430007-ORB		Oil Rubbed Bronze	---	\$11.10
OP-430012	Aerator - Female 55/64" Thread 1.0 GPM Flow Rate	Chrome	---	\$10.50
OP-430012-BN		PVD Brushed Nickel	---	\$11.60
OP-430012-ORB		Oil Rubbed Bronze	---	\$12.80
OP-430011	Aerator - Female 55/64" Thread 0.5 GPM Flow Rate	Chrome	---	\$8.80
OP-430011-BN		PVD Brushed Nickel	---	\$13.80
OP-430011-ORB		Oil Rubbed Bronze	---	\$14.80





**CENTRAL
BRASS** //

2019 CENTRAL BRASS PRODUCT CATALOG PRICE INDEX

2019 CENTRAL BRASS PRODUCT CATALOG PRICE INDEX

MODEL	PAGE	PCS/ CS	LIST PRICE	MODEL	PAGE	PCS/ CS	LIST PRICE	MODEL	PAGE	PCS/ CS	LIST PRICE
0005-H1/2P	211	6	\$60.50	0048-UA3	177	6	\$155.00	0121-A	171	6	\$144.00
0006-H1/2C	211	6	\$44.00	0048-UA4	177	6	\$155.50	0122-A	171	6	\$139.00
0006-H1/2H	211	6	\$44.00	0048-UA6	177	6	\$156.00	0122-ELS17	172	6	\$180.30
0007-1/2	211	6	\$52.50	0048-ULE0	177	6	\$143.00	0122-LE1	171	6	\$132.00
0007-H1/2	211	6	\$55.00	0048-ULE3	177	6	\$158.00	0122-LE17	171	6	\$157.50
0031-H1/2C	211	6	\$80.20	0050-ULERC	179	6	\$156.50	0122-LE6	171	6	\$142.00
0031-H1/2H	211	6	\$80.20	0050-ULERC-QI	179	6	\$172.00	0122-LE60	158	4	\$474.00
0031-H1/2P	211	6	\$80.20	0050-URC	179	6	\$153.50	0122-LE61	159	4	\$505.10
0033-1/2CV-02	211	6	\$110.00	0050-URC-QI	179	6	\$176.00	0123-A	171	6	\$154.00
0033-1/2HV-02	211	6	\$110.00	0051-TRC	179	6	\$137.00	0123-A07	171	6	\$186.30
0033-1/2PV-02	211	6	\$110.00	0051-URC	179	6	\$126.50	0123-LE1	171	6	\$147.00
0045-LE0	176	6	\$229.50	0054-ULE-Q	179	6	\$193.00	0123-LE2	171	6	\$171.00
0045-LE60	156	4	\$448.90	0054-ULE-QI	179	6	\$238.00	0123-LE6	171	6	\$157.00
0045-LE60-AD0	156	4	\$563.90	0054-ULERC-Q	179	6	\$171.00	0125-A	173	6	\$132.00
0045-LE61	157	4	\$477.10	0054-ULERC-QI	179	6	\$185.00	0126-A	173	6	\$147.00
0046-LE0	177	6	\$238.00	0054-U-Q	179	6	\$190.00	0127-A	173	6	\$149.50
0047-SA	176	6	\$122.85	0054-U-QI	179	6	\$235.00	0127-LE1	173	6	\$135.00
0047-SA1	176	6	\$131.85	0054-URC-Q	179	6	\$169.00	0127-LE6	173	6	\$152.50
0047-SL	176	6	\$110.00	0054-URC-QI	179	6	\$182.00	0128-A	173	6	\$164.50
0047-SLE0	176	6	\$125.85	0054-YELRC-Q	179	6	\$246.00	0128-LE1	173	6	\$150.00
0047-TA	176	6	\$122.85	0054-YELSRC-Q	179	6	\$240.80	0128-LE6	173	6	\$167.50
0047-TA1	176	6	\$131.85	0054-YRC-Q	179	6	\$215.00	0146-A	173	6	\$118.50
0047-TA3	176	6	\$137.85	0084-A	184	6	\$96.00	0148-LE1	173	6	\$121.50
0047-TA4	176	6	\$138.35	0084-A1	184	6	\$105.00	0148-LE6	173	6	\$142.00
0047-TLE0	176	6	\$125.85	0084-A17	184	6	\$111.50	0149-LE1	173	6	\$136.50
0047-TLE17	176	6	\$141.35	0084-A3	184	6	\$111.00	0149-LE6	173	6	\$157.00
0047-UA	176	6	\$125.00	0084-A4	184	6	\$111.50	0184-LE0	187	6	\$103.00
0047-UA1	176	6	\$134.00	0084-A6	184	6	\$112.00	0184-LE60	160	4	\$484.80
0047-UA2	176	6	\$139.00	0084-EL17	185	6	\$142.50	0184-LE60-AD0	160	4	\$600.80
0047-UA3	176	6	\$140.00	0084-ELS17	185	6	\$137.30	0184-LE61	161	4	\$534.20
0047-UA3-Q	176	6	\$141.80	0084-ELS17-E0.5	185	6	\$148.60	0194-LE0	187	6	\$92.00
0047-UA4	176	6	\$140.50	0084-H	184	6	\$97.30	0194-LE60	160	4	\$435.10
0047-ULE0	176	6	\$128.00	0084-LE0	184	6	\$99.00	0194-LE60-AD0	160	4	\$550.10
0047-ULE17	176	6	\$143.50	0084-LE17	185	6	\$114.50	0194-LE61	161	4	\$483.50
0047-ULE3	176	6	\$143.00	0084-LE60	158	4	\$472.20	0206	201	6	\$58.50
0047-ULE60	156	4	\$433.90	0084-LE60-AD0	158	4	\$587.20	0208	201	6	\$71.00
0047-ULE60-AD0	156	4	\$548.90	0084-LE61	159	4	\$520.60	0209	201	6	\$80.50
0047-ULE60-AD1	156	4	\$557.90	0094-A	184	6	\$85.00	0210	202	6	\$71.00
0047-ULE61	157	4	\$441.70	0094-A1	184	6	\$94.00	0210-Q	202	6	\$72.50
0048-SA	177	6	\$142.00	0094-A17	184	6	\$100.50	0211	202	6	\$131.00
0048-SLE0	177	6	\$145.00	0094-A3	184	6	\$100.00	0211-Q	202	6	\$132.50
0048-TA	177	6	\$130.00	0094-ELS17	184	6	\$126.30	0239-AP	192	6	\$53.50
0048-TA1	177	6	\$139.00	0094-H	184	6	\$86.30	0239-P	192	6	\$49.50
0048-TA2	177	6	\$144.00	0094-H1	184	6	\$95.30	0255-AC	192	6	\$80.50
0048-TA3	177	6	\$145.00	0094-H3	184	6	\$101.30	0255-AH	192	6	\$80.50
0048-TA4	177	6	\$145.50	0094-LE0	184	6	\$88.00	0255-AP	192	6	\$80.50
0048-TA-Q	177	6	\$131.80	0094-LE0-Q	184	6	\$89.80	0255-AVC	192	6	\$83.80
0048-TLE0	177	6	\$133.00	0094-LE17	184	6	\$100.50	0255-C	192	6	\$73.40
0048-UA	177	6	\$140.00	0112-AL	217	36	\$19.00	0255-H	192	6	\$73.40
0048-UA1	177	6	\$149.00	0120-A	171	6	\$129.00	0255-P	192	6	\$73.40
0048-UA2	177	6	\$154.00	0120-L	171	6	\$123.00	0280-AC	182	6	\$107.00

2019 CENTRAL BRASS PRODUCT CATALOG PRICE INDEX

MODEL	PAGE	PCS/ CS	LIST PRICE	MODEL	PAGE	PCS/ CS	LIST PRICE	MODEL	PAGE	PCS/ CS	LIST PRICE
0280-AC17	182	6	\$116.50	0364-N2	207	6	\$156.00	0650-60-AD0	165	4	\$543.90
0280-AH	182	6	\$107.00	0365-L	207	6	\$158.50	0660	168	---	\$93.90
0280-LE60	162	4	\$366.80	0365-LV	207	6	\$161.80	0661	169	---	\$92.10
0281-AC	182	6	\$92.50	0366-HX8	209	6	\$248.80	0808-Z	193	8	\$108.40
0281-AH	182	6	\$92.50	0366-HX8V	209	6	\$252.10	0826	193	8	\$117.75
0282	182	6	\$82.80	0366-HX8VWB	209	6	\$288.80	0850	194	8	\$108.75
0284-A-Q	183	6	\$164.00	0366-HX8WB	209	6	\$285.50	0868	194	8	\$190.80
0285-A-Q	183	6	\$178.00	0366-HX8WBD	209	6	\$307.00	0868-Z	194	8	\$160.25
0285-LE60-AD0-Q	162	4	\$481.80	0366-L	207	6	\$156.00	0897	193	8	\$143.50
0285-LE61-Q	164	4	\$454.50	0366-LV	207	6	\$159.30	0905	194	8	\$95.25
0286-AC	182	6	\$80.50	0366-N2	209	6	\$152.00	0908	194	8	\$146.40
0286-AH	182	6	\$80.50	0366-N2HX8WB	209	6	\$285.50	0908-Z	194	8	\$116.40
0287-A17	183	6	\$147.00	0376	210	12	\$37.00	0926	195	8	\$126.25
0287-ELS17	183	6	\$174.60	0377	210	12	\$61.80	0950	196	8	\$116.75
0287-LE17	183	6	\$147.00	0393	181	6	\$82.00	0951	196	8	\$147.25
0287-LE18	183	6	\$148.80	0396	181	20	\$107.00	0961	196	8	\$196.80
0287-LE60-AD0-Q	163	4	\$541.00	0397	181	10	\$126.00	0961-Z	196	8	\$166.80
0287-LE60-Q	163	4	\$426.00	0398-ULE0	178	6	\$79.00	0968	196	8	\$197.90
0287-LE61-Q	164	4	\$466.50	0398-ULEEX0	178	6	\$94.00	0968-Z	196	8	\$168.25
0289-A	183	6	\$135.00	0425	210	40	\$28.60	0971	196	8	\$228.00
0331-1/2	212	6	\$69.40	0426	210	40	\$21.90	0971-Z	196	8	\$198.00
0331-3/8	212	6	\$68.00	0455	186	8	\$116.50	0997	195	8	\$152.00
0331-L1/2	212	6	\$71.00	0465	186	6	\$74.75	1008-B	228	1	\$2.50
0331-L3/8	212	6	\$70.00	0465-5	186	6	\$83.75	1011-N	228	1	\$7.50
0331-LV3/8	212	6	\$73.30	0465-LE	186	6	\$77.75	1012-N	228	1	\$9.00
0331-V1/2	212	6	\$72.70	0466	186	6	\$64.00	1109	216	12	\$40.00
0333-1/2	212	6	\$71.90	0466-5	186	6	\$73.00	1109-BP	216	12	\$50.00
0333-3/8	212	6	\$70.90	0468	186	6	\$95.50	1109-BPLG	216	12	\$46.00
0333-L1/2	212	6	\$73.50	0468-5	186	6	\$104.50	1109-LG	216	12	\$37.50
0333-L3/8	212	6	\$72.90	0469	186	6	\$102.50	1125-A	190	6	\$149.00
0333-LV1/2	212	6	\$76.80	0469-5	186	6	\$111.50	1125-DA	190	6	\$179.00
0334-1/2	203	6	\$70.00	0470	186	6	\$96.50	1130	215	6	\$114.60
0335-1/2	203	6	\$72.40	0470-5	186	6	\$105.50	1131-B	215	6	\$78.50
0335-V1/2	203	6	\$75.70	0471-RC	186	6	\$150.50	1132-B	215	6	\$88.50
0336-N2-1/2	212	6	\$79.50	0477	201	4	\$105.00	1133-A	189	6	\$113.50
0336-N2-3/8	212	6	\$77.50	0477-RC	201	4	\$110.00	1133-DLE	189	6	\$148.00
0342-1/2	216	6	\$20.00	0555	213	36	\$44.50	1133-LE	189	6	\$116.50
0342-1/2VB	216	6	\$65.60	0555-D	213	36	\$47.50	1137-A	188	6	\$112.00
0342-3/8	216	6	\$19.50	0575-1/2	214	6	\$38.00	1137-AELS	188	6	\$132.00
0355-AN2C	192	6	\$114.50	0575-1/2CP	214	6	\$64.00	1137-AELS-Q	188	6	\$133.80
0355-AN2H	192	6	\$114.50	0576-1/2	214	6	\$38.00	1137-DA	188	6	\$144.00
0355-AN2P	192	6	\$114.50	0576-1/2CP	214	6	\$64.00	1137-DAEL	188	6	\$175.00
0355-AVN2C	192	6	\$117.50	0576-3/4	214	6	\$38.00	1137-DAELS	188	6	\$164.00
0355-AVN2P	192	6	\$117.50	0607-C1/2	213	6	\$41.00	1137-DA-Q	188	6	\$145.80
0356-AN2C	192	6	\$136.00	0607-C3/4	213	6	\$42.00	1137-DLE	188	6	\$147.00
0356-AN2P	192	6	\$136.00	0640	166	4	\$343.20	1137-LE	188	6	\$115.00
0360	208	6	\$89.30	0641	166	4	\$387.20	1138-A	188	6	\$119.00
0361	208	36	\$77.80	0642-LE0	167	6	\$115.00	1138-LE	188	6	\$122.00
0362	208	36	\$74.40	0650-0	170	---	\$120.00	1167-AV	189	6	\$249.10
0364-L	207	6	\$163.40	0650-17	170	6	\$135.50	1172-11AELS-Q	190	6	\$198.00
0364-LV	207	6	\$166.70	0650-60	165	4	\$428.90	1172-EL17	175	6	\$203.00

2019 CENTRAL BRASS PRODUCT CATALOG PRICE INDEX

MODEL	PAGE	PCS/CS	LIST PRICE	MODEL	PAGE	PCS/CS	LIST PRICE	MODEL	PAGE	PCS/CS	LIST PRICE
1172-ELS17	175	6	\$197.80	3137-DAN2	189	6	\$238.00	80084-LE60-AD0	158	4	\$597.20
1172-ELS17-E0.5	175	6	\$207.30	3145-D	229	1	\$62.50	80084-LE60-AD1	158	4	\$606.20
1172-LE17-Q	175	6	\$175.00	3154-Z	229	1	\$13.00	80122-A	171	6	\$149.50
1172-LE6-Q	174	6	\$159.50	3362	229	1	\$30.00	80122-A07	171	6	\$181.80
1173-LE6-Q	174	6	\$174.50	390	227	1	\$7.00	80122-EL17	172	6	\$190.80
1177-A	189	6	\$134.30	510	227	1	\$7.10	80122-ELS17	171	6	\$190.80
1177-AV	189	6	\$137.30	521-B	227	1	\$8.40	80123-A	171	6	\$164.50
1177-DA	189	6	\$166.30	524-B	228	1	\$6.00	80285-LE60-AD0	162	4	\$491.80
1177-DLE	189	6	\$169.30	530	228	1	\$5.50	80285-LE60-AD1	162	4	\$500.80
1177-LE	189	6	\$137.30	6056	197	8	\$86.50	80286-AC	182	6	\$85.50
1178-A	189	6	\$167.50	6076	197	8	\$143.00	80287-A17	183	6	\$148.50
1178-DA	189	6	\$199.50	6086-Z	197	8	\$106.75	80287-LE60-AD0	163	4	\$551.00
1178-DLE	189	6	\$202.50	61-LC	226	1	\$3.50	80287-LE60-AD1	163	4	\$560.00
1178-LE	189	6	\$171.50	61-LU	226	1	\$2.50	80465	186	6	\$85.25
1240	202	6	\$97.50	6266	197	8	\$117.25	80466	186	6	\$74.50
1246	203	6	\$93.50	7074-L	229	1	\$18.50	80642-LE0	167	6	\$125.50
1379	200	6	\$218.00	714-WT-02	228	1	\$9.50	80642-LE1	167	6	\$134.50
1379-L	200	6	\$152.00	7255-M	229	1	\$3.00	80805	193	8	\$101.25
1380	200	6	\$234.50	731-K	228	1	\$23.50	80826	193	8	\$132.25
1380-L	200	6	\$170.50	781-A	228	1	\$15.00	80850	194	8	\$123.25
1555	205	6	\$97.00	80045-LE60	156	4	\$458.90	80868	194	8	\$205.30
157-I	226	1	\$31.50	80045-LE60-AD0	156	4	\$573.90	80868-C3	194	8	\$314.50
1645	204	6	\$97.60	80045-LE60-AD1	156	4	\$582.90	80868-L3	194	8	\$296.00
1645-17	204	6	\$108.00	80047-TA3	176	6	\$147.85	80868-Z	194	8	\$174.75
1645-CO	204	6	\$108.00	80047-TLE0	176	6	\$135.85	80897	193	8	\$158.00
1645-PR	204	6	\$100.90	80047-UA	176	6	\$135.50	80897-C3	193	8	\$234.00
1645-S	204	6	\$125.90	80047-UA1	176	6	\$144.50	80897-L3	193	8	\$222.00
1655	205	6	\$99.80	80047-UA3	176	6	\$150.50	80905	194	8	\$109.75
1655-P	205	6	\$99.80	80047-ULE0	176	6	\$138.50	80926	195	8	\$140.75
1655-X	205	6	\$103.80	80047-ULE3	176	6	\$153.50	80950	196	8	\$131.25
1655-X1817	205	6	\$122.70	80047-ULE60	156	4	\$443.90	80968	196	8	\$212.40
1665-WX	205	6	\$110.10	80047-ULE60-AD0	156	4	\$558.90	80968-Z	196	8	\$182.75
1665-XP17	205	6	\$127.60	80047-ULE60-AD1	156	4	\$567.90	80971	196	8	\$242.50
1675	204	6	\$117.20	80047-ULE60-AD23	156	4	\$575.40	80971-Z	196	8	\$212.50
1675-S	205	6	\$138.70	80047-ULE60-AD3	156	4	\$573.90	80997	195	8	\$166.50
2056-SPT1109	229	1	\$5.00	80048-TA	177	6	\$140.50	81125-A	190	6	\$159.50
2126-A	229	1	\$6.00	80048-TLE0	176	6	\$135.85	81125-DA	190	6	\$189.50
268-TVR	227	1	\$3.00	80048-UA	177	6	\$150.50	81137-A	188	6	\$122.50
2985-J	229	1	\$29.70	80048-ULE0	176	6	\$153.50	81137-AELS	188	6	\$142.50
3034-1/2-02	229	1	\$17.90	80048-ULE3	176	6	\$168.50	81137-DA	188	6	\$154.50
3042-A	229	1	\$25.00	80050-U-I	179	6	\$233.10	81137-DAELS	188	6	\$174.50
3042-P	229	1	\$8.00	80050-ULERC-I	179	6	\$235.10	81137-DLE	188	6	\$157.50
3061-AZ1/2	229	1	\$25.00	80051-ULERC	179	6	\$129.50	81137-LE	188	6	\$125.50
3105	216	10	\$22.00	80054-U-I	179	6	\$245.50	81172-D12AL1	190	6	\$292.50
3105-BP	216	10	\$23.00	80084-A	184	6	\$106.50	81172-D12AL1-BN	190	6	\$350.50
3106	217	10	\$44.00	80084-A17	185	6	\$122.00	85-FW	226	1	\$1.00
312-10N	227	1	\$15.50	80084-AELS	184	6	\$132.30	990-L	228	1	\$5.00
3127-AN1	191	6	\$270.00	80084-ELS17	185	6	\$147.80	CS-13001C	230	1	\$20.50
3127-AVN1	191	6	\$273.00	80084-LE0	184	6	\$109.50	CS-13001H	230	1	\$20.50
3137-AN2	189	6	\$206.00	80084-LE17	184	6	\$125.00	CS-13001P	230	1	\$20.50
3137-AVN2	189	6	\$209.00	80084-LE60	158	4	\$482.20	CS-13002C	230	1	\$14.40

2019 CENTRAL BRASS PRODUCT CATALOG PRICE INDEX

MODEL	PAGE	PCS/ CS	LIST PRICE	MODEL	PAGE	PCS/ CS	LIST PRICE	MODEL	PAGE	PCS/ CS	LIST PRICE
CS-13002H	230	1	\$14.40	CS-42015	168	---	\$8.50	CS-53003	230	1	\$7.20
CS-13003P	230	1	\$5.40	CS-42016	168	---	\$27.50	CS-53004	230	1	\$9.00
CS-13004C	230	1	\$113.30	CS-42017	168	---	\$7.70	CS-63003	230	1	\$36.00
CS-13004H	230	1	\$113.30	CS-42018	169	---	\$32.00	CS-63004	230	1	\$277.00
CS-14001C	230	1	\$45.00	CS-42019	169	---	\$38.90	CS-63005	230	1	\$40.50
CS-14001H	230	1	\$45.00	CS-42020	168	---	\$11.90	CS-65001	180	6	\$60.50
CS-14001P	230	1	\$45.00	CS-42026	168	---	\$1.00	CS-65002	180	6	\$44.60
CS-14002C	230	1	\$52.00	CS-42027	168	---	\$68.20	CS-66001	206	30	\$35.50
CS-14002H	230	1	\$52.00	CS-42028	168	---	\$19.90	CS-66001-BN	206	30	\$38.50
CS-14002P	230	1	\$52.00	CS-42032	168	---	\$10.40	CS-66002	206	30	\$37.00
CS-15001	230	1	\$15.50	CS-42033	168	---	\$24.20	CS-66002-BN	206	30	\$39.50
CS-19001C	230	1	\$31.00	CS-43001	230	1	\$58.50	CS-66003	206	30	\$31.50
CS-19001H	230	1	\$31.00	CS-43005	230	1	\$9.50	CS-66003-BN	206	30	\$33.50
CS-19002C	230	1	\$28.90	CS-43006	230	1	\$9.50	CS-66004	206	30	\$32.00
CS-19002H	230	1	\$28.90	CS-43007	230	1	\$3.00	CS-66004-BN	206	30	\$35.00
CS-19003C	230	1	\$36.40	CS-43008	230	1	\$4.50	G-1043	228	1	\$10.10
CS-19003H	230	1	\$36.40	CS-43009	230	1	\$57.00	G-1043-C	228	1	\$26.60
CS-19004C	230	1	\$33.50	CS-44001	230	1	\$20.60	G-128-52	226	2	\$2.00
CS-19004H	230	1	\$33.50	CS-44002	230	1	\$4.00	G-1548-ET	228	1	\$33.00
CS-19005	230	1	\$54.50	CS-45002	215	1	\$40.50	G-1588-CT	228	1	\$16.50
CS-19006	230	1	\$53.40	CS-45003	215	1	\$15.50	G-1748-88W	217	10	\$14.60
CS-19007C	168	---	\$14.10	CS-46001	230	1	\$2.40	G-195-DST9	216	1	\$7.75
CS-19007H	168	---	\$14.10	CS-47001	230	2	\$5.50	G-2090-S	229	1	\$28.00
CS-19007P	168	---	\$13.90	CS-48001	230	1	\$19.00	G-21	226	1	\$9.50
CS-22001	230	1	\$68.00	CS-49003	230	1	\$13.50	G-2115-TP	229	1	\$7.50
CS-22002	230	1	\$37.50	CS-49004	230	1	\$12.50	G-218-A	227	1	\$14.00
CS-22003	221	---	\$83.50	CS-49005	230	1	\$9.00	G-284	227	1	\$11.50
CS-22004	219	---	\$42.20	CS-49007	230	1	\$8.00	G-285-AZ	231	1	\$11.50
CS-22005	219	---	\$44.00	CS-49008	230	1	\$6.50	G-2887	229	1	\$104.00
CS-23002	230	1	\$90.50	CS-49009	230	1	\$10.50	G-29-A	226	1	\$15.10
CS-25001	230	1	\$32.50	CS-49011	230	1	\$3.50	G-3009-A	229	1	\$34.00
CS-34001C	225	---	\$27.00	CS-49012	230	1	\$4.00	G-3036-A	229	1	\$61.35
CS-34001H	225	---	\$27.00	CS-49013	230	1	\$4.50	G-30-C	226	1	\$13.50
CS-34001V	225	---	\$21.50	CS-49014	230	1	\$3.50	G-3113-6	229	1	\$30.50
CS-39001	225	---	\$9.50	CS-49015	230	1	\$6.50	G-3131	229	1	\$70.00
CS-39002	225	---	\$49.50	CS-49016C	225	---	\$37.00	G-3359-A	229	1	\$14.50
CS-39003	225	---	\$66.50	CS-49016H	225	---	\$37.00	G-392	227	1	\$18.50
CS-39004	225	---	\$33.00	CS-49016P	225	---	\$37.00	G-398-C	227	1	\$8.00
CS-39005C	225	1	\$11.00	CS-49017C	225	---	\$36.50	G-398-H	227	1	\$8.00
CS-39005H	225	1	\$11.00	CS-49017H	225	---	\$36.50	G-4147-C	229	1	\$31.50
CS-42001	230	1	\$33.50	CS-49018C	230	1	\$2.00	G-4147-H	229	1	\$31.50
CS-42002	180	---	\$35.20	CS-49018H	230	1	\$2.00	G-4149-C	229	1	\$34.00
CS-42003	180	---	\$31.80	CS-49019	230	1	\$0.75	G-4149-H	229	1	\$34.00
CS-42004	180	---	\$39.80	CS-49020	230	1	\$2.00	G-454-EL	225	---	\$10.00
CS-42005	168	---	\$77.80	CS-49026	230	1	\$3.60	G-454-ER	225	---	\$10.00
CS-42006	168	---	\$77.80	CS-49027	230	1	\$3.10	G-458-KL	225	---	\$17.20
CS-42010	169	---	\$12.90	CS-49029	231	1	\$3.30	G-458-KR	225	---	\$17.20
CS-42011	168	---	\$19.30	CS-49032	226	1	\$14.00	G-508-C	227	1	\$11.00
CS-42012	168	---	\$11.50	CS-52001	168	---	\$6.10	G-508-D	227	1	\$11.00
CS-42013	169	---	\$77.00	CS-53001	230	1	\$4.50	G-508-H	227	1	\$11.00
CS-42014	169	---	\$15.40	CS-53002	230	1	\$6.00	G-518-C	227	1	\$16.50

2019 CENTRAL BRASS PRODUCT CATALOG PRICE INDEX





MODEL	PAGE	PCS/ CS	LIST PRICE	MODEL	PAGE	PCS/ CS	LIST PRICE	MODEL	PAGE	PCS/ CS	LIST PRICE
G-518-H	227	1	\$16.50	PF-725-A	228	1	\$50.00	SU-363-MA	227	1	\$41.40
G-520-W	227	1	\$4.95	PF-731-G	228	1	\$9.50	SU-363-MH	227	1	\$42.90
G-521-BWD	227	1	\$8.40	PF-741-DO	228	1	\$8.00	SU-363-RA	227	1	\$28.70
G-523-C	227	1	\$6.00	PF-752-T	228	1	\$36.00	SU-363-RH	227	1	\$30.30
G-523-H	228	1	\$6.00	PF-768-D	228	1	\$8.00	SU-365-CA	227	1	\$51.50
G-5355-S	229	1	\$10.50	PF-776-D	228	1	\$10.50	SU-365-CH	227	1	\$53.50
G-6928-V	229	1	\$43.90	SU-1043-S	228	1	\$9.00	SU-511-A	227	1	\$28.70
G-7114-V	229	1	\$44.00	SU-1109	228	1	\$38.50	SU-61-LC	226	1	\$8.00
G-7116-V	229	1	\$43.50	SU-1548-605	225	---	\$21.50	SU-61-LCPP	226	1	\$17.00
G-7233	229	1	\$35.00	SU-157-DA	226	1	\$45.20	SU-61-LDP	226	1	\$32.00
G-7237	229	1	\$23.30	SU-157-G	226	1	\$46.50	SU-61-LEP	226	1	\$31.50
G-7237-477	229	1	\$34.50	SU-157-GLA	226	1	\$54.50	SU-6965	229	1	\$68.00
G-756-E	228	1	\$2.50	SU-157-GRA	226	1	\$37.50	SU-7071	229	1	\$123.50
G-83-ACZ	226	1	\$10.00	SU-157-GSA	226	1	\$37.00	SU-7101-AF	229	1	\$10.50
G-83-AZ	226	1	\$22.00	SU-157-HA	226	1	\$59.00	SU-756-CB	228	1	\$5.00
G-913-A	228	1	\$6.50	SU-157-JA	226	1	\$63.20	SU-767	228	1	\$15.20
G-914-SA	228	1	\$7.00	SU-157-KRA	226	1	\$83.50	SU-83-AZ	226	1	\$15.80
G-94-F	226	1	\$2.50	SU-157-KSA	226	1	\$84.00	SU-85-APF	226	1	\$12.00
G-95-A	226	1	\$3.00	SU-1839-P	225	---	\$21.50	SU-85-FA	226	1	\$15.00
G-97	226	1	\$3.00	SU-1839-PRC	225	---	\$23.10	SU-85-K	226	1	\$13.00
K-2-CT	225	---	\$32.00	SU-1855-47RPRC	225	---	\$13.00	SU-85-KM	226	1	\$14.00
K-2-DT	225	---	\$57.10	SU-2051-P	229	1	\$13.80	SU-85-U	226	1	\$5.50
K-351-C	225	---	\$39.50	SU-2090-A	229	1	\$123.00	T-2	199	6	\$28.60
K-351-H	225	---	\$39.50	SU-2090-AB	229	1	\$122.50	T-2-BN	199	6	\$39.50
K-352-C	225	---	\$30.50	SU-2136-FA	229	1	\$74.00	T-2-C3	199	6	\$109.00
K-352-H	225	---	\$30.50	SU-257-JSA	227	1	\$131.70	T-2-C3-BN	199	6	\$115.50
K-361	225	---	\$40.60	SU-257-TSA	227	1	\$92.00	T-2-L3	199	6	\$97.00
K-3-CT	225	---	\$20.50	SU-266-P	227	1	\$5.50	T-2-L3-BN	199	6	\$103.00
K-3-DT	225	---	\$21.00	SU-2775-R-02	217	10	\$42.00	T-3	199	6	\$48.30
K-454-C	225	---	\$11.00	SU-2806	229	1	\$51.00	T-3-BN	199	6	\$63.10
K-454-H	225	---	\$11.00	SU-2807	229	1	\$34.60	T-3-C3	199	6	\$164.00
PF-1043-A	228	1	\$3.50	SU-2841-ARC	229	1	\$82.00	T-3-C3-BN	199	6	\$173.00
PF-1090-J	228	1	\$3.50	SU-2841-S	229	1	\$108.00	T-3-L3	199	6	\$145.00
PF-161-D	226	1	\$8.10	SU-2846	229	1	\$38.70	T-3-L3-BN	199	6	\$154.50
PF-177-G	227	1	\$8.70	SU-2923-A	229	1	\$69.50	TC-2	198	6	\$51.10
PF-218-A	227	1	\$12.00	SU-2924-A	229	1	\$26.50	TC-2-BN	198	6	\$83.30
PF-259-X	227	1	\$14.00	SU-2924-H-01	229	1	\$21.50	TC-2-C3	198	6	\$193.70
PF-263-D	227	1	\$9.70	SU-2924-H-02	229	1	\$26.50	TC-2-C3-BN	198	6	\$200.70
PF-3359-A	229	1	\$10.00	SU-2929-01	229	1	\$36.00	TC-2-L3	198	6	\$180.30
PF-358-Q	227	1	\$4.00	SU-2987-DA	229	1	\$7.50	TC-2-L3-BN	198	6	\$188.00
PF-358-RS	227	1	\$9.50	SU-3026-B	229	1	\$41.00	TC-3	198	6	\$68.70
PF-398-B8	227	1	\$87.00	SU-3026-CDL	229	1	\$23.50	TC-3-BN	198	6	\$103.70
PF-5075-YP	229	1	\$6.00	SU-3130-M	229	1	\$61.00	TC-3-C3	199	6	\$240.70
PF-6928-P	229	1	\$39.70	SU-3359-A	229	1	\$31.50	TC-3-C3-BN	199	6	\$251.45
PF-6930	229	1	\$18.90	SU-357-HSA	227	1	\$115.00	TC-3-L3	199	6	\$229.80
PF-7114-P	229	1	\$41.10	SU-357-WSA	227	1	\$106.00	TC-3-L3-BN	199	6	\$232.20
PF-7114-PS	229	1	\$45.30	SU-358-SA	227	1	\$9.00	TCR-2	198	6	\$61.10
PF-7125	229	1	\$9.60	SU-363-JA	227	1	\$36.90	TCR-2-BN	198	6	\$93.30
PF-7125-C	229	1	\$9.60	SU-363-JH	227	1	\$38.45	TCR-3	198	6	\$78.70
PF-7125-H	229	1	\$9.60	SU-363-LA	227	1	\$40.30	TCR-3-BN	198	6	\$113.70
PF-714-RT	228	1	\$154.70	SU-363-LH	227	1	\$41.90	TR-2	199	6	\$39.60

2019 CENTRAL BRASS PRODUCT CATALOG PRICE INDEX

MODEL	PAGE	PCS/ CS	LIST PRICE	MODEL	PAGE	PCS/ CS	LIST PRICE	MODEL	PAGE	PCS/ CS	LIST PRICE
TR-2-BN	199	6	\$49.50	X222-D	227	6	\$2.00	X945	228	2	\$3.50
TR-3	199	6	\$58.30	X263-BC	227	10	\$13.50	X947-C	228	10	\$4.00
TR-3-BN	199	6	\$73.10	X269-29/16	227	10	\$29.50	X954-AN	228	10	\$2.00
U-1615-50RC	228	1	\$110.30	X279-D	227	10	\$2.50	X977	228	10	\$4.50
U-1615-54-02	228	1	\$186.50	X279-E	227	10	\$4.00	X991	228	4	\$3.00
U-1615-54-04	228	1	\$139.00	X279-L	227	10	\$1.75	X991-A	228	4	\$7.00
U-2170-AL	229	1	\$61.50	X279-V	227	10	\$3.00	X991-C	228	4	\$3.50
U-2170-AR	229	1	\$61.50	X28-A	226	6	\$2.25	XCS-42021	168	6	\$6.50
U-2171-A	229	1	\$38.00	X3	226	6	\$4.00	XCS-42022	168	10	\$2.50
X1009-A	228	2	\$12.00	X3008-X	229	2	\$6.00	XCS-42023	168	10	\$4.70
X1028-Y	228	25	\$2.50	X33-A	226	6	\$2.00	XCS-42025	168	10	\$4.70
X1038-453	228	25	\$4.00	X358-U	227	10	\$1.50	XCS-42029	168	5	\$19.00
X1038-IN	228	10	\$3.50	X358-V	227	10	\$4.50	XCS-44002	231	10	\$38.00
X1038-KN	228	25	\$7.00	X4	226	6	\$4.00	XCS-45004	231	2	\$5.00
X1038-S	231	2	\$1.20	X4015	231	1	\$5.50	XCS-45005	231	2	\$2.50
X1038-W	228	10	\$4.00	X402-A	227	25	\$2.00	XCS-45006	231	5	\$1.00
X103-HS	226	6	\$2.00	X402-B	227	12	\$4.00	XCS-45007	231	5	\$1.00
X103-HSSS	226	6	\$2.00	X4079-3/8	229	1	\$11.50	XCS-47001	168	2	\$15.00
X103-PLCP	226	6	\$3.00	X409-PT	227	12	\$4.00	XCS-49001	231	10	\$1.00
X104	226	25	\$3.00	X42	226	6	\$3.50	XCS-49002	231	10	\$2.00
X1043-B	228	6	\$4.00	X420-N	227	12	\$2.00	XCS-49033	168	10	\$2.90
X1043-FN	228	2	\$1.50	X427-WS	227	12	\$7.00	XCS-53005	231	4	\$2.00
X1043-T	228	6	\$2.50	X433-AN	227	12	\$6.00	XG-1867-ALCP	228	2	\$17.50
X105	226	25	\$3.00	X491-S	227	12	\$10.50	XPF-166-U	227	2	\$7.00
X105-H	226	6	\$3.00	X491-U	227	12	\$7.50	XPF-263-B	227	4	\$5.00
X107-F	226	25	\$4.50	X4-L	226	6	\$2.00	XPF-263-C	227	2	\$6.00
X107-FB	226	5	\$3.00	X4-MA	226	6	\$2.00	XPF-460	231	2	\$6.90
X107-FR	226	5	\$3.00	X4-N	226	6	\$1.50	XPF-59	226	10	\$13.00
X107-H	226	6	\$3.00	X53-AS	226	6	\$7.00	XPF-67-AC	226	10	\$5.00
X1081-N	228	10	\$2.00	X53-AZ	226	6	\$6.90	XPF-782-D	228	2	\$6.00
X113-P	226	6	\$1.00	X53-CZ	226	6	\$7.50	XPF-784-C	228	2	\$6.00
X126-S	226	6	\$0.75	X54	226	10	\$3.00	XSU-1548-BSP	228	2	\$36.50
X127-AP21/4	226	6	\$6.50	X68-HX	226	10	\$8.00	XSU-1858-A	225	---	\$22.50
X1549	228	2	\$19.50	X69-C	226	10	\$3.00	XSU-233-B	227	2	\$12.10
X165	227	10	\$13.00	X700-KT	228	2	\$14.10				
X165-6500	227	2	\$5.00	X70-WA	226	6	\$6.25				
X166-FN	227	6	\$1.00	X71	226	2	\$13.50				
X166-Q	227	6	\$2.00	X7133-AZ	229	10	\$7.00				
X168-B	227	4	\$3.00	X765-TA	228	6	\$9.00				
X1875	228	2	\$6.00	X809	228	10	\$2.50				
X1875-C	228	2	\$6.00	X814-BARP	228	10	\$10.00				
X1876-BB	228	2	\$9.00	X82-J	226	6	\$2.00				
X193-LBN	227	6	\$1.50	X848-B	228	10	\$3.50				
X194	227	6	\$1.00	X85-U	226	2	\$2.00				
X195-C	227	6	\$2.00	X901-WNN	228	25	\$3.50				
X207-B	227	6	\$2.50	X904-N	228	6	\$1.65				
X2133-210	229	2	\$49.20	X913-N	228	10	\$2.00				
X218-B	227	10	\$6.50	X936-A	228	6	\$4.50				
X218-C	227	10	\$4.00	X940	228	10	\$3.00				
X218-F	227	2	\$6.50	X940-TRN	228	10	\$3.50				
X22	226	6	\$2.00	X944-N	228	2	\$1.50				



KITCHEN // Pre-Rinse Faucets

PRE-RINSE FAUCETS

	Model#	Description	Finish	Case	Price	
 <p>Shown With Add-On Spout</p>		0045-LE60 Two Handle Ledge Pre-Rinse Faucet 2-3/8" Lever Handle 24" Quick Install Riser With Spring Guide 44" Flexible Stainless Steel Hose Replaceable Seats Back Flow Preventers 1/2-14 NPS Female Thread 1.1 GPM Flow Rate Spray Valve 2-Hole 8" Installation Pipe Strap and Hook Assembly	Polished Chrome	4	\$448.90	
		80045-LE60 Ceramic Disc Cartridges	Polished Chrome	4	\$458.90	
		The same as 0045-LE60 with:				
		0045-LE60-AD0 Secondary Control Valve Add-On Faucet 6" Swivel Tube Spout - 1.5 GPM Flow Rate	Polished Chrome	4	\$563.90	
		80045-LE60-AD0 Secondary Control Valve Add-On Faucet 6" Swivel Tube Spout - 1.5 GPM Flow Rate Ceramic Disc Cartridges	Polished Chrome	4	\$573.90	
	80045-LE60-AD1 Secondary Control Valve Add-On Faucet 8" Swivel Tube Spout - 1.5 GPM Flow Rate Ceramic Disc Cartridges	Polished Chrome	4	\$582.90		
 <p>Shown Less Add-On Spout</p>		0047-ULE60 Two Handle Wallmount Pre-Rinse Faucet 2-3/8" Lever Handle 24" Quick Install Riser With Spring Guide 44" Flexible Stainless Steel Hose Replaceable Seats Back Flow Preventers 1/2-14 NPS Female Thread 1.1 GPM Flow Rate Spray Valve 2-Hole 7-7/8" to 8-1/8" Installation Pipe Strap and Hook Assembly	Polished Chrome	4	\$433.90	
		80047-ULE60 Ceramic Disc Cartridges	Polished Chrome	4	\$443.90	
		The same as 0047-ULE60 with:				
		0047-ULE60-AD0 Secondary Control Valve Add-On Faucet 6" Swivel Tube Spout 1.5 GPM Flow Rate	Polished Chrome	4	\$548.90	
		0047-ULE60-AD1 Secondary Control Valve Add-On Faucet 8" Swivel Tube Spout 1.5 GPM Flow Rate	Polished Chrome	4	\$557.90	
		80047-ULE60-AD0 Secondary Control Valve Add-On Faucet 6" Swivel Tube Spout Ceramic Disc Cartridges 1.5 GPM Flow Rate	Polished Chrome	4	\$558.90	
		80047-ULE60-AD1 Secondary Control Valve Add-On Faucet 8" Swivel Tube Spout Ceramic Disc Cartridges 1.5 GPM Flow Rate	Polished Chrome	4	\$567.90	
		80047-ULE60-AD3 Secondary Control Valve Add-On Faucet 12" Swivel Tube Spout Ceramic Disc Cartridges 1.5 GPM Flow Rate	Polished Chrome	4	\$573.90	
80047-ULE60-AD23 Secondary Control Valve Add-On Faucet 18" Swivel Tube Spout Ceramic Disc Cartridges 1.5 GPM Flow Rate	Polished Chrome	4	\$575.40			

KITCHEN // Pre-Rinse Faucets

PRE-RINSE FAUCETS







	Model#	Description	Finish	Case	Price
	0045-LE61	Two Handle Ledge Pre-Rinse Faucet 2-3/8" Lever Handle Overhead Swivel 12" Reach and 27-3/4" High Arm 26" Flexible Stainless Steel Hose Replaceable Seats Back Flow Preventers 1/2-14 NPS Female Thread 1.1 GPM Flow Rate Spray Valve 2-Hole 8" Installation Pipe Strap and Hook Assembly	Polished Chrome	4	\$477.10
	0047-ULE61	Two Handle Wallmount Pre-Rinse Faucet 2-3/8" Lever Handle Overhead Swivel 12" Reach and 27-3/4" High Arm 26" Flexible Stainless Steel Hose Replaceable Seats Back Flow Preventers 1/2-14 NPS Female Thread 1.1 GPM Flow Rate Spray Valve 2-Hole 7-7/8" to 8-1/8" Installation Pipe Strap and Hook Assembly	Polished Chrome	4	\$441.70

Central Brass faucets feature sprayheads that meet ANSI/ASME A112.18.1 flow requirements of 1.1 GPM

KITCHEN

KITCHEN // Pre-Rinse Faucets







PRE-RINSE FAUCETS

	Model#	Description	Finish	Case	Price	
 <p>Shown Less Add-On Spout</p>	  0084-LE60	Two Handle Cast Brass Pre-Rinse Faucet 2-3/8" Lever Handle 24" Quick Install Riser With Spring Guide 44" Flexible Stainless Steel Hose Replaceable Seats Back Flow Preventers 1.1 GPM Flow Rate Spray Valve 2 or 3-Hole 4" Installation Pipe Strap and Hook Assembly	Polished Chrome	4	\$472.20	
	80084-LE60	Ceramic Disc Cartridges	Polished Chrome	4	\$482.20	
	The same as 0084-LE60 with:					
	0084-LE60-AD0	Secondary Control Valve Add-On Faucet 6" Swivel Tube Spout 1.5 GPM Flow Rate	Polished Chrome	4	\$587.20	
	80084-LE60-AD0	Secondary Control Valve Add-On Faucet 6" Swivel Tube Spout Ceramic Disc Cartridges 1.5 GPM Flow Rate	Polished Chrome	4	\$597.20	
80084-LE60-AD1	Secondary Control Valve Add-On Faucet 8" Swivel Tube Spout Ceramic Disc Cartridges 1.5 GPM Flow Rate	Polished Chrome	4	\$606.20		
	  0122-LE60	Two Handle Cast Brass Pre-Rinse Faucet 2-3/8" Lever Handle 24" Quick Install Riser With Spring Guide 44" Flexible Stainless Steel Hose Replaceable Seats Back Flow Preventers 1.1 GPM Flow Rate Spray Valve 3-Hole 8" Installation Pipe Strap and Hook Assembly	Polished Chrome	4	\$474.00	

Central Brass faucets feature sprayheads that meet ANSI/ASME A112.18.1 flow requirements of 1.1 GPM

KITCHEN // Pre-Rinse Faucets





PRE-RINSE FAUCETS

	Model#	Description	Finish	Case	Price
	  0084-LE61	Two Handle Pre-Rinse Faucet 2-3/8" Lever Handle Overhead Swivel 12" Reach and 27-3/4" High Arm 26" Flexible Stainless Steel Hose Replaceable Seats Back Flow Preventers 1.1 GPM Flow Rate Spray Valve 2 or 3-Hole 4" Installation Pipe Strap and Hook Assembly	Polished Chrome	4	\$520.60
	  0122-LE61	Two Handle Cast Brass Pre-Rinse Faucet 2-3/8" Lever Handle Overhead Swivel 12" Reach and 27-3/4" High Arm 26" Flexible Stainless Steel Hose Replaceable Seats Back Flow Preventers 1.1 GPM Flow Rate Spray Valve 3-Hole 8" Installation Pipe Strap and Hook Assembly	Polished Chrome	4	\$505.10

Central Brass faucets feature sprayheads that meet ANSI/ASME A112.18.1 flow requirements of 1.1 GPM

KITCHEN // Pre-Rinse Faucets



PRE-RINSE FAUCETS

	Model#	Description	Finish	Case	Price	
 <p>Shown Less Add-On Spout</p>		0184-LE60 Two Handle Cast Brass Wallmount Pre-Rinse Faucet 2-3/8" Lever Handle 24" Quick Install Riser With Spring Guide 44" Flexible Stainless Steel Hose Replaceable Seats Back Flow Preventers 1.1 GPM Flow Rate Spray Valve 2-Hole 4" Installation Pipe Strap and Hook Assembly	Polished Chrome	4	\$484.80	
		The same as 0184-LE60 with:				
		0184-LE60-AD0 Secondary Control Valve Add-On Faucet 6" Swivel Tube Spout 1.5 GPM Flow Rate	Polished Chrome	4	\$600.80	
 <p>Shown With Add-On Spout</p>		0194-LE60 Two Handle Shell Type Wallmount Pre-Rinse Faucet 2-3/8" Lever Handle 24" Quick Install Riser With Spring Guide 44" Flexible Stainless Steel Hose Replaceable Seats Back Flow Preventers 1.1 GPM Flow Rate Spray Valve 2-Hole 4" Installation Pipe Strap and Hook Assembly	Polished Chrome	4	\$435.10	
		The same as 0194-LE60 with:				
		0194-LE60-AD0 Secondary Control Valve Add-On Faucet 6" Swivel Tube Spout 1.5 GPM Flow Rate	Polished Chrome	4	\$550.10	

Central Brass faucets feature sprayheads that meet ANSI/ASME A112.18.1 flow requirements of 1.1 GPM

KITCHEN // Pre-Rinse Faucets





PRE-RINSE FAUCETS

	Model#	Description	Finish	Case	Price
	0184-LE61	Two Handle Cast Brass Wallmount Pre-Rinse Faucet 2-3/8" Lever Handle Overhead Swivel 12" Reach and 27-3/4" High Arm 26" Flexible Stainless Steel Hose Replaceable Seats Back Flow Preventers 1.1 GPM Flow Rate Spray Valve 2-Hole 4" Installation Pipe Strap and Hook Assembly	Polished Chrome	4	\$534.20
	0194-LE61	Two Handle Shell Type Wallmount Pre-Rinse Faucet 2-3/8" Lever Handle Overhead Swivel 12" Reach and 27-3/4" High Arm 26" Flexible Stainless Steel Hose Replaceable Seats Back Flow Preventers 1.1 GPM Flow Rate Spray Valve 2-Hole 4" Installation Pipe Strap and Hook Assembly	Polished Chrome	4	\$483.50

Central Brass faucets feature sprayheads that meet ANSI/ASME A112.18.1 flow requirements of 1.1 GPM

KITCHEN // Pre-Rinse Faucets



PRE-RINSE FAUCETS

	Model#	Description	Finish	Case	Price
	 0280-LE60	Single Handle Pre-Rinse Faucet 2-3/4" Lever Handle 24" Quick Install Riser With Spring Guide 44" Flexible Stainless Steel Hose Replaceable Seat Back Flow Preventers 1/2-14 NPS Male inlet x 1-7/8" Long 1.1 GPM Flow Rate Spray Valve 1-Hole Installation Pipe Strap and Hook Assembly	Polished Chrome	4	\$366.80
 Shown Less Add-On Spout	 0285-LE60-AD0-Q	Two Handle Pre-Rinse Faucet 2-3/8" Lever Handle 24" Quick Install Riser With Spring Guide 44" Flexible Stainless Steel Hose Quick-Pression Quarter-Turn Stems Replaceable Seats Back Flow Preventers Easy-Install 30" Flex Supply Lines With 3/8" Connections 1.1 GPM Flow Rate Spray Valve 1-Hole Installation Pipe Strap and Hook Assembly Secondary Control Valve Add-On Faucet 6" Swivel Tube Spout 1.1 GPM Flow Rate	Polished Chrome	4	\$481.80
	The same as 0285-LE60-Q with:				
	80285-LE60-AD0	Ceramic Disc Cartridges	Polished Chrome	4	\$491.80
	80285-LE60-AD1	8" Swivel Tube Spout Ceramic Disc Cartridges 1.1 GPM Flow Rate	Polished Chrome	4	\$500.80

Central Brass faucets feature sprayheads that meet ANSI/ASME A112.18.1 flow requirements of 1.1 GPM

KITCHEN // Pre-Rinse Faucets



PRE-RINSE FAUCETS

	Model#	Description	Finish	Case	Price	
 <p>Shown With Add-On Spout</p>	 	0287-LE60-Q Two Handle Pre-Rinse Faucet 2-3/8" Lever Handle 24" Quick Install Riser With Spring Guide 44" Flexible Stainless Steel Hose Quick-Pression Quarter-Turn Stems Replaceable Seats Back Flow Preventers Easy-Install 30" Flex Supply Lines With 3/8" Connections 1.1 GPM Flow Rate Spray Valve 1-Hole Installation Pipe Strap and Hook Assembly	Polished Chrome	4	\$426.00	
	The same as 0287-LE60-Q with:					
		0287-LE60-AD0-Q	Secondary Control Valve Add-On Faucet 6" Swivel Tube Spout 1.1 GPM Flow Rate	Polished Chrome	4	\$541.00
		80287-LE60-AD0	Secondary Control Valve Add-On Faucet 6" Swivel Tube Spout Ceramic Disc Cartridges 1.1 GPM Flow Rate	Polished Chrome	4	\$551.00
	80287-LE60-AD1	Secondary Control Valve Add-On Faucet 8" Swivel Tube Spout Ceramic Disc Cartridges 1.1 GPM Flow Rate	Polished Chrome	4	\$560.00	

Central Brass faucets feature sprayheads that meet ANSI/ASME A112.18.1 flow requirements of 1.1 GPM

KITCHEN // Pre-Rinse Faucets







PRE-RINSE FAUCETS

	Model#	Description	Finish	Case	Price
	0285-LE61-Q	Two Handle Pre-Rinse Faucet 2-3/8" Lever Handle Overhead Swivel 12" Reach and 27-3/4" High Arm 26" Flexible Stainless Steel Hose Quick-Pression Quarter-Turn Stems Replaceable Seats Back Flow Preventers Easy-Install 30" Flex Supply Lines With 3/8" Connections 1.1 GPM Flow Rate Spray Valve 1-Hole Installation Pipe Strap and Hook Assembly	Polished Chrome	4	\$454.50
	0287-LE61-Q	Two Handle Pre-Rinse Faucet 2-3/8" Lever Handle Overhead Swivel 12" Reach and 27-3/4" High Arm 26" Flexible Stainless Steel Hose Quick-Pression Quarter-Turn Stems Replaceable Seats Back Flow Preventers Easy-Install 30" Flex Supply Lines With 3/8" Connections 1.1 GPM Flow Rate Spray Valve 1-Hole Installation Pipe Strap and Hook Assembly	Polished Chrome	4	\$466.50

Central Brass faucets feature sprayheads that meet ANSI/ASME A112.18.1 flow requirements of 1.1 GPM

KITCHEN // Pre-Rinse Faucets

PRE-RINSE FAUCETS





	Model#	Description	Finish	Case	Price
	  0650-60	Single Handle Pre-Rinse Faucet Lever Handle 24" Quick Install Riser With Spring Guide 44" Flexible Stainless Steel Hose Ceramic Disc Cartridge With Temperature Limit Stop Back Flow Preventers Easy-Install 30" Flex Supply Lines With 3/8" Connections 1.1 GPM Flow Rate Spray Valve 2-Hole 4" to 6" Installation Pipe Strap and Hook Assembly	Polished Chrome	4	\$428.90
	  0650-60-AD0	Single Handle Pre-Rinse Faucet Lever Handle 24" Quick Install Riser With Spring Guide 44" Flexible Stainless Steel Hose Ceramic Disc Cartridge With Temperature Limit Stop Back Flow Preventers Easy-Install 30" Flex Supply Lines With 3/8" Connections 1.1 GPM Flow Rate Spray Valve 2-Hole 4" to 6" Installation Pipe Strap and Hook Assembly Secondary Control Valve Add-On Faucet 6" Swivel Tube Spout 1.1 GPM Flow Rate	Polished Chrome	4	\$543.90

Central Brass faucets feature sprayheads that meet ANSI/ASME A112.18.1 flow requirements of 1.1 GPM

KITCHEN

KITCHEN // Pre-Rinse Faucets



PRE-RINSE FAUCETS

	Model#	Description	Finish	Case	Price
	 0640	Pre-Rinse Assembly 24" Quick Install Riser With Spring Guide 44" Flexible Stainless Steel Hose Back Flow Preventers Quick Install Adapters to retrofit on T&S, Chicago Faucets, and Fisher 1.1 GPM Flow Rate Spray Valve Pipe Strap and Hook Assembly	Polished Chrome	4	\$343.20
	 0641	Pre-Rinse Assembly Overhead Swivel 12" Reach and 27-3/4" High Arm 26" Flexible Stainless Steel Hose Back Flow Preventers Quick Install Adapters to retrofit on T&S, Chicago Faucets, and Fisher 1.1 GPM Flow Rate Spray Valve Pipe Strap and Hook Assembly	Polished Chrome	4	\$387.20

Central Brass faucets feature sprayheads that meet ANSI/ASME A112.18.1 flow requirements of 1.1 GPM

KITCHEN // Pre-Rinse Faucets

PRE-RINSE FAUCETS

		Model#	Description	Finish	Case	Price
	 	0642-LE0	Add-On Faucet 2-3/8" Lever Handle Replaceable Seats 6" Swivel Tube Spout 1.5 GPM Flow Rate	Polished Chrome	6	\$115.00
		80642-LE0	Add-On Faucet 2-3/8" Lever Handle Ceramic Disc Cartridge Replaceable Seats 6" Swivel Tube Spout 1.5 GPM Flow Rate	Polished Chrome	6	\$125.50
Suffix #						
		1	8" Swivel Tube Spout with Aerator (SU-363-RA)		---	\$9.00
		2	10" Swivel Tube Spout with Aerator (SU-363-JA)		---	\$14.00
		3	12" Swivel Tube Spout with Aerator (SU-363-LA)		---	\$15.00
		4	14" Swivel Tube Spout with Aerator (SU-363-MA)		---	\$15.50
		6	8" Brass Swivel D-Spout with Aerator (SU-365-CA)		---	\$16.00
		07	8-3/4" Swivel Gooseneck Spout with Aerator (SU-357-WSA)		---	\$32.30
		8	7-1/4" High-Rise Spout with Aerator (SU-357-HSA)		---	\$43.30
		9	5" Cast Brass Spout With Aerator (SU-2923-A)		---	\$21.30
		13	16" Swivel Tube Spout With Aerator (CS-22004)		---	\$16.00
		17	4-3/32" Rigid/Swivel Combo Gooseneck Spout With Aerator (CS-22002)		---	\$15.50
		18	5-1/2" Rigid/Swivel Combo Gooseneck Spout With Aerator (CS-22003)		---	\$35.30
		23	18" Swivel Tube Spout With Aerator (CS-22005)		---	\$16.50
		EX	7" Cast Brass Spout Extension (SU-2775-R-02)		---	\$15.00
		F	Full Flow Streamer (CS-49029)		---	\$3.00
		GRA*	4-3/32" Rigid Gooseneck Spout With Aerator (SU-157-GRA)		---	\$15.50
		GSA*	4-3/32" Swivel Gooseneck Spout With Aerator (SU-157-GSA)		---	\$15.50
		KRA*	5-1/2" Rigid Gooseneck Spout With Aerator (SU-157-KRA)		---	\$34.80
		KSA*	4-1/2" Swivel Gooseneck Spout With Aerator (SU-157-KSA)		---	\$35.30



* Obsolete once stock is depleted

KITCHEN // Pre-Rinse Faucets

PRE-RINSE FAUCETS

	Model#	Description	Finish	Pack	Price
PARTS	CS-42011	Drain Adapter 2" Female to 1-1/2" Male	---	---	\$19.30
	CS-42012	Drain Adapter 1-1/2" Male to 1-1/2" Male	---	---	\$11.50
	CS-42015	Hose Adapter With Check Valve	---	---	\$8.50
	CS-42016	Spring Body	Polished Chrome	---	\$27.50
	CS-42017	Finger Hook and Screw	Polished Chrome	---	\$7.70
	CS-42020	Body Adapter	---	---	\$11.90
	XCS-42021	Friction Brass Washer	---	6	\$6.50
	XCS-42022	Body Adapter Washer	---	10	\$2.50
	XCS-42023	Hose Adapter Washer	---	10	\$4.70
	XCS-47001	10 mm Check Valve	---	2	\$15.00
	XCS-42025	Hose Washer	---	10	\$4.70
	CS-42026	1/4" Allen Wrench	---	---	\$1.00
	CS-42027	20" Flexible Stainless Steel Hose	---	---	\$68.20
	CS-42028	Adapter Package	Chrome	---	\$19.90
	XCS-42029	15 mm Check Valve	---	5	\$19.00
	CS-42032	Escutcheon	---	---	\$10.40
	CS-42033	Shank and Flange Assembly	Polished Chrome	---	\$24.20
	XCS-49033	1/8" Allen Screw	---	10	\$2.90
	CS-52001	Mounting Kit	---	---	\$6.10

PRE-RINSE FAUCET ACCESSORIES

	Model#	Description	Finish	Case	Price
	CS-19007C	Lever Handle With Vandal Proof Screw-Cold	Polished Chrome	---	\$14.10
	CS-19007H	Lever Handle With Vandal Proof Screw-Hot	Polished Chrome	---	\$14.10
	CS-19007P	Lever Handle With Vandal Proof Screw-Plain	Polished Chrome	---	\$13.90
	CS-42005	Pre-rinse Spray Integrated Stainless Steel Clip to Hold Handle Open One Piece Stainless Steel Nozzle Rubber Nozzle Bumper Serviceable Components Chrome Plate Handle with PVC Coating for Heat Resistance Brass Valve Stem with stainless Steel Spring 1.6 GPM Flow Rate Forged Brass Valve Body	Polished Chrome	---	\$77.80
	CS-42006	Pre-rinse Spray Integrated Stainless Steel Clip to Hold Handle Open One Piece Stainless Steel Nozzle Rubber Nozzle Bumper Serviceable Components Chrome Plate Handle with PVC Coating for Heat Resistance Brass Valve Stem with stainless Steel Spring 1.1 GPM Flow Rate Forged Brass Valve Body	Polished Chrome	---	\$77.80
 Shown w/ CS-42011 Adapter	0660	Waste Drain Valve Twist Handle 2" Drain, Optional adapter available for 1-1/2" Drain Rough Chrome Plated Body Twist Handle with Heat Resistant Plastic Grip 3-1/2" Snap-in removable Strainer Overflow Outlet & Cap	Polished Chrome	---	\$93.90



KITCHEN // Pre-Rinse Accessories

PRE-RINSE FAUCET ACCESSORIES

	Model#	Description	Finish	Case	Price
 Shown w/ CS-42011 Adapter	0661	Waste Drain Valve Lever Handle 2" Drain, Optional Adapter Available for 1-1/2" Drain Rough Chrome Plated Body Lever Handle with Heat Resistant Plastic Grip 3-1/2" Snap-in Removable Strainer Overflow Outlet & Cap	Polished Chrome	---	\$92.10
	CS-42010	Spray Repair Kit	---	---	\$12.90
	CS-42013	44" Flexible Stainless Steel Hose	---	---	\$77.00
	CS-42014	Overhead Spring	Polished Chrome	---	\$15.40
	CS-42017	Finger Hook and Screw	Polished Chrome	---	\$7.70
	CS-42018	12" Adjustable Wall Bracket	Polished Chrome	---	\$32.00
	CS-42019	24" Riser	Polished Chrome	---	\$38.90

KITCHEN // Single Handle Faucets

SINGLE HANDLE KITCHEN FAUCETS





	Model#	Description	Finish	Case	Price
 <p>Shown Less Spout</p>		0650-0 Single Handle Kitchen Faucet Lever Handle 6" Tube Swivel Spout Ceramic Disc Cartridge With Temperature Limit Stop 2-Hole 4" to 6" Installation Easy-Install 30" Flex Supply Lines With 3/8" Connections 1.5 GPM Flow Rate	Polished Chrome	---	\$120.00
	3 12-Inch Tube Spout with Aerator (SU-363-LA)	---	\$15.00		
	4 14-Inch Tube Spout with Aerator (SU-363-MA)	---	\$15.50		
	8 7-1/4-Inch High-Rise Spout with Aerator (SU-357-HSA)	---	\$43.30		
	07 8-3/4-Inch High-Rise Swivel Gooseneck Spout with Aerator (SU-357-WSA)	---	\$32.30		
	17 4-3/32" Rigid/Swivel Combo Gooseneck Spout With Aerator (CS-22002)	---	\$15.50		
	18 5-1/2" Rigid/Swivel Combo Gooseneck Spout With Aerator (CS-22003)	---	\$35.30		
	GRA* 4-3/32-Inch Rigid Gooseneck Spout with Aerator (SU-157-GRA)	---	\$15.50		
	GSA* 4-3/32-Inch Swivel Gooseneck Spout with Aerator (SU-157-GSA)	---	\$15.50		
	KRA* 5-1/2-Inch Rigid Gooseneck Spout with Aerator (SU-157-KRA)	---	\$34.80		
	KSA* 5-1/2-Inch Swivel Gooseneck Spout with Aerator (SU-157-KSA)	---	\$35.30		
	ELS 4-Inch Wrist Handles (G-4147-C,H) Color-coded Indexes	---	\$25.80		
	EL 6-Inch Elbow Handles (G-4149-C,H) Color-coded Indexes	---	\$31.00		
	Q Quarter-Turn Stems (G-454-EL,ER)	---	\$1.80		
	TSA1 6-3/8-Inch Swivel Tri-Arc Gooseneck Spout with Aerator (CS-22001)	---	\$29.00		
	L2 Lever Handles-Indexes (CS-19002C,H)	---	\$53.80		
	C2 Cross Handles-Indexes (CS-19004C,H)	---	\$64.50		
	E1.0 1.0 GPM Flow Rate (CS-49011-Male Aerator/CS-49012-Female Aerator)	---	\$4.00		
	E0.5 0.5 GPM Flow Rate (CS-49009-Male Aerator/CS-49010-Female Aerator)	---	\$9.50		

*Obsolete once stock is depleted. Replaced with Suffix (17,18)

Central Brass faucets feature aerators that meet ANSI/ASME A112.18.1 flow requirements of 1.5 GPM

KITCHEN // Two Handle Faucets



TWO HANDLE KITCHEN FAUCETS

	Model#	Description	Finish	Case	Price
	0122-LE1	Two Handle Cast Brass Kitchen Faucet 2-3/8" Lever Handles 8" Tube Swivel Spout Quick-Pression Quarter-Turn Stems, Replaceable Seats 3-Hole 8" Installation 1.5 GPM Flow Rate	Polished Chrome	6	\$132.00
	0120-A	Canopy Handles	Polished Chrome	6	\$129.00
	0123-LE1	Two Handle Cast Brass Kitchen Faucet 2-3/8" Lever Handles 8" Tube Swivel Spout Quick-Pression Quarter-Turn Stems, Replaceable Seats 4-Hole 8" Installation Side Spray Assembly 1.5 GPM Flow Rate	Polished Chrome	6	\$147.00
	0121-A	Canopy Handles	Polished Chrome	6	\$144.00
	0122-LE6	Two Handle Cast Brass Kitchen Faucet 2-3/8" Lever Handles 8" D Style Swivel Spout Quick-Pression Quarter-Turn Stems, Replaceable Seats 3-Hole 8" Installation 1.5 GPM Flow Rate	Polished Chrome	6	\$142.00
	0122-A	Canopy Handles	Polished Chrome	6	\$139.00
	80122-A	Ceramic Disc Cartridges	Polished Chrome	6	\$149.50
	0123-LE6	Two Handle Cast Brass Kitchen Faucet 2-3/8" Lever Handles 8" D Style Swivel Spout Quick-Pression Quarter-Turn Stems, Replaceable Seats 4-Hole 8" Installation Side Spray Assembly 1.5 GPM Flow Rate	Polished Chrome	6	\$157.00
	0123-A	Canopy Handles	Polished Chrome	6	\$154.00
	80123-A	Ceramic Disc Cartridges	Polished Chrome	6	\$164.50
Suffix #	2	10-Inch Tube Spout with Aerator (SU-363-JA)		---	\$14.00
	3	12-Inch Tube Spout with Aerator (SU-363-LA)		---	\$15.00
	4	14-Inch Tube Spout with Aerator (SU-363-MA)		---	\$15.50
	8	7-1/4-Inch High-Rise Spout with Aerator (SU-357-HSA)		---	\$43.30
	07	8-3/4-Inch High-Rise Swivel Gooseneck Spout with Aerator (SU-357-WSA)		---	\$32.30
	17	4-3/32" Rigid/Swivel Combo Gooseneck Spout With Aerator (CS-22002)		---	\$15.50
	18	5-1/2" Rigid/Swivel Combo Gooseneck Spout With Aerator (CS-22003)		---	\$35.30
	ELS	4-Inch Wrist Handles (G-4147-C,H) Color-coded Indexes		---	\$25.80
	EL	6-Inch Elbow Handles (G-4149-C,H) Color-coded Indexes		---	\$31.00
	Q	Quarter-Turn Stems (G-454-EL,ER)		---	\$1.80
	TSA1	6-3/8-Inch Swivel Tri-Arc Gooseneck Spout with Aerator (CS-22001)		---	\$29.00
	L2	Lever Handles-Indexes (CS-19002C,H)		---	\$53.80
	C2	Cross Handles-Indexes (CS-19004C,H)		---	\$64.50
	E1.0	1.0 GPM Flow Rate (CS-49011-Male Aerator/CS-49012-Female Aerator)		---	\$4.00
	E0.5	0.5 GPM Flow Rate (CS-49009-Male Aerator/CS-49010-Female Aerator)		---	\$9.50

Central Brass faucets feature aerators that meet ANSI/ASME A112.18.1 flow requirements of 1.5 GPM

KITCHEN // Two Handle Faucets















TWO HANDLE KITCHEN FAUCETS

	Model#	Description	Finish	Case	Price
	 0122-ELS17	Two Handle Cast Brass Kitchen Faucet 4" Wrist Blade Handles with Color-Coded Indexes 4-3/32" Reach Gooseneck Rigid/Swivel Spout Quick-Pression Quarter-Turn Stems, Replaceable Seats 3-Hole 8" Installation 1.5 GPM Flow Rate	Polished Chrome	6	\$180.30
	80122-EL17	Ceramic Disc Cartridges	Polished Chrome	6	\$190.80

Central Brass faucets feature aerators that meet ANSI/ASME A112.18.1 flow requirements of 1.5 GPM

KITCHEN // Two Handle Faucets

TWO HANDLE KITCHEN FAUCETS

		Model#	Description	Finish	Case	Price
		0127-LE1	Two Handle Cast Brass Kitchen Faucet 2-3/8" Lever Handle 8" Tube Swivel Spout Quick-Pression Quarter-Turn Stems, Replaceable Seats 3-Hole 6" Installation 1.5 GPM Flow Rate	Polished Chrome	6	\$135.00
		0125-A	Canopy Handles	Polished Chrome	6	\$132.00
		0128-LE1	Two Handle Cast Brass Kitchen Faucet 2-3/8" Lever Handle 8" Tube Swivel Spout Quick-Pression Quarter-Turn Stems, Replaceable Seats 4-Hole 6" Installation Side Spray Assembly 1.5 GPM Flow Rate	Polished Chrome	6	\$150.00
		0126-A	Canopy Handles	Polished Chrome	6	\$147.00
		0127-LE6	Two Handle Cast Brass Kitchen Faucet 2-3/8" Lever Handle 8" D Style Swivel Spout Quick-Pression Quarter-Turn Stems, Replaceable Seats 3-Hole 6" Installation 1.5 GPM Flow Rate	Polished Chrome	6	\$152.50
		0127-A	Canopy Handles	Polished Chrome	6	\$149.50
		0128-LE6	Two Handle Cast Brass Kitchen Faucet 2-3/8" Lever Handle 8" D Style Swivel Spout Quick-Pression Quarter-Turn Stems, Replaceable Seats 4-Hole 6" Installation Side Spray Assembly 1.5 GPM Flow Rate	Polished Chrome	6	\$167.50
		0128-A	Canopy Handles	Polished Chrome	6	\$164.50
		0148-LE1	Two Handle Shell Type Kitchen Faucet 2-3/8" Lever Handle 8" Tube Swivel Spout Quick-Pression Quarter-Turn Stems, Replaceable Seats 3-Hole 8" Installation 1.5 GPM Flow Rate	Polished Chrome	6	\$121.50
		0146-A	Canopy Handles	Polished Chrome	6	\$118.50
		0149-LE1	Two Handle Shell Type Kitchen Faucet 2-3/8" Lever Handle 8" Tube Swivel Spout Quick-Pression Quarter-Turn Stems, Replaceable Seats 4-Hole 8" Installation Side Spray Assembly 1.5 GPM Flow Rate	Polished Chrome	6	\$136.50
		0148-LE6	Two Handle Shell Type Kitchen Faucet 2-3/8" Lever Handle 8" D Style Swivel Spout Quick-Pression Quarter-Turn Stems, Replaceable Seats 3-Hole 8" Installation 1.5 GPM Flow Rate	Polished Chrome	6	\$142.00
		0149-LE6	Two Handle Shell Type Kitchen Faucet 2-3/8" Lever Handles 8" D Style Swivel Spout Quick-Pression Quarter-Turn Stems, Replaceable Seats 4-Hole 8" Installation Side Spray Assembly 1.5 GPM Flow Rate	Polished Chrome	6	\$157.00

Central Brass faucets feature aerators that meet ANSI/ASME A112.18.1 flow requirements of 1.5 GPM



KITCHEN

KITCHEN // Two Handle Faucets

TWO HANDLE KITCHEN FAUCETS

Suffix #	Model#	Description	Finish	Case	Price
	2	10-Inch Tube Spout with Aerator (SU-363-JA)	---	---	\$14.00
	3	12-Inch Tube Spout with Aerator (SU-363-LA)	---	---	\$15.00
	4	14-Inch Tube Spout with Aerator (SU-363-MA)	---	---	\$15.50
	8	7-1/4-Inch High-Rise Spout with Aerator (SU-357-HSA)	---	---	\$43.30



TWO HANDLE KITCHEN FAUCETS

	Model#	Description	Finish	Case	Price
	1172-LE6-Q	Two Handle Concealed Ledge Kitchen Faucet 2-3/8" Lever Handles 8" D Style Swivel Spout Flexible Hose Connections Quarter-Turn Stems Replaceable Seats 3-Hole 6" to 24" Installation 1.5 GPM Flow Rate Note: Mounting Thickness Cannot Exceed 1-3/8"	Polished Chrome	6	\$159.50
	1173-LE6-Q	Two Handle Concealed Ledge Kitchen Faucet 2-3/8" Lever Handles 8" D Style Swivel Spout Flexible Hose Connections Quarter-Turn Stems Replaceable Seats 4-Hole 6" to 24" Installation Side Spray Assembly 1.5 GPM Flow Rate Note: Mounting Thickness Cannot Exceed 1-3/8"	Polished Chrome	6	\$174.50
Suffix #	8	7-1/4-Inch High-Rise Spout with Aerator (SU-357-HSA)		---	\$43.30
	07	8-3/4-Inch High-Rise Swivel Gooseneck Spout with Aerator (SU-357-WSA)		---	\$32.30
	17	4-3/32" Rigid/Swivel Combo Gooseneck Spout With Aerator (CS-22002)		---	\$15.50
	18	5-1/2" Rigid/Swivel Combo Gooseneck Spout With Aerator (CS-22003)		---	\$35.30
	ELS	4-Inch Wrist Handles (G-4147-C,H) Color-coded Indexes		---	\$25.80
	EL	6-Inch Elbow Handles (G-4149-C,H) Color-coded Indexes		---	\$31.00
	TSA1	6-3/8-Inch Swivel Tri-Arc Gooseneck Spout with Aerator (CS-22001)		---	\$29.00
	L1	Widespread Lever Handles-Indexes (CS-19001C,H)		---	\$59.25
	C1	Widespread Cross Handles-Indexes (CS-19003C,H)		---	\$69.75
	E1.0	1.0 GPM Flow Rate (CS-49011-Male Aerator/CS-49012-Female Aerator)		---	\$4.00
	E0.5	0.5 GPM Flow Rate (CS-49009-Male Aerator/CS-49010-Female Aerator)		---	\$9.50

Central Brass faucets feature aerators that meet ANSI/ASME A112.18.1 flow requirements of 1.5 GPM

KITCHEN // Two Handle Faucets







TWO HANDLE KITCHEN FAUCETS

	Model#	Description	Finish	Case	Price
	1172-EL17	Two Handle Concealed Ledge Kitchen Faucet 6" Elbow Handles with Color-Coded Indexes 4-3/32" Gooseneck Swivel Spout Flexible Hose Connections Quarter-Turn Stems Replaceable Seats 3-Hole 6" to 24" Installation 1.5 GPM Flow Rate Note: Mounting Thickness Cannot Exceed 1-3/8"	Polished Chrome	6	\$203.00
	1172-ELS17	Two Handle Concealed Ledge Kitchen Faucet 4" Wrist Blade Handles with Color-Coded Indexes 4-3/32" Gooseneck Swivel Spout Flexible Hose Connections Quarter-Turn Stems Replaceable Seats 3-Hole 6" to 24" Installation 1.5 GPM Flow Rate Note: Mounting Thickness Cannot Exceed 1-3/8"	Polished Chrome	6	\$197.80

Central Brass faucets feature aerators that meet ANSI/ASME A112.18.1 flow requirements of 1.5 GPM









KITCHEN // Wallmount/Ledge Faucets

WALLMOUNT/LEDGE KITCHEN FAUCETS

		Model#	Description	Finish	Case	Price
		0045-LE0	Two Handle Ledge Kitchen Faucet 2-3/8" Lever Handles 6" Tube Swivel Spout 1/2-14 NPS Male Thread Quick-Pression Quarter-Turn Stems, Replaceable Seats 2-Hole 8" Installation 1.5 GPM Flow Rate	Polished Chrome	6	\$229.50
		0047-TLE0	Two Handle Wallmount Kitchen Faucet 2-3/8" Lever Handles 6" Tube Swivel Spout 1/2-14 NPT Male Thread Quick-Pression Quarter-Turn Stems, Replaceable Seats 2-Hole 7-7/8" to 8-1/8" Installation 1.5 GPM Flow Rate	Polished Chrome	6	\$125.85
		80047-TLE0	Ceramic Disc Cartridges	Polished Chrome	6	\$135.85
		0047-TA	Canopy Handles	Polished Chrome	6	\$122.85
		0047-SLE0	Same as 0047 with 1/2-14 NPS Female Thread 2-Hole 6-1/2 to 9-1/2-Inch Installation 2-3/8" Lever Handles	Polished Chrome	6	\$125.85
		0047-SA	Canopy Handles	Polished Chrome	6	\$122.85
		0047-SL	Canopy Handles	Polished Chrome	6	\$110.00
		0047-UA	Same as 0047 with 1/2-14 NPS Female Thread 2-Hole 7-7/8" to 8-1/8" Installation	Polished Chrome	6	\$125.00
		80047-UA	Ceramic Disc Cartridges, Canopy Handles	Polished Chrome	6	\$135.50
				0047-ULE0	Two Handle Wallmount Kitchen Faucet 2-3/8" Lever Handles 6" Tube Swivel Spout 1/2-14 NPS Female Thread Quick-Pression Quarter-Turn Stems, Replaceable Seats 2-Hole 7-7/8" to 8-1/8" Installation 1.5 GPM Flow Rate	Polished Chrome
0047-UA3	Canopy Handle			Polished Chrome	6	\$140.00
80047-UA3	Ceramic Disc Cartridges, Canopy Handles			Polished Chrome	6	\$150.50
Suffix #		1	8-Inch Tube Spout with Aerator (SU-363-RA)		---	\$9.00
		2	10-Inch Tube Spout with Aerator (SU-363-JA)		---	\$14.00
		3	12-Inch Tube Spout with Aerators (SU-363-LA)		---	\$15.00
		4	14-Inch Tube Spout with Aerators (SU-363-MA)		---	\$15.50
		6	8-Inch Brass D-Spout with Aerator (SU-365-CA)		---	\$16.00
		9	5-Inch Cast Brass Spout with Aerator (SU-2923-A)		---	\$21.30
		17	4-3/32" Rigid/Swivel Combo Gooseneck Spout With Aerator (CS-22002)		---	\$15.50
		18	5-1/2" Rigid/Swivel Combo Gooseneck Spout With Aerator (CS-22003)		---	\$35.30
		H	Hose Adapter (PF-784-C)		---	\$1.30
		ELS	4-Inch Wrist Handles (G-4147-C,H) Color-coded Indexes		---	\$25.80
		EL	6-Inch Elbow Handles (G-4149-C,H) Color-coded Indexes		---	\$31.00
		Q	Quarter-Turn Stems (G-454-EL,ER)		---	\$1.80
		E1.0	1.0 GPM Flow Rate (CS-49011-Male Aerator/CS-49012-Female Aerator)		---	\$4.00
		E0.5	0.5 GPM Flow Rate (CS-49009-Male Aerator/CS-49010-Female Aerator)		---	\$9.50

KITCHEN // Wallmount/Ledge Faucets



WALLMOUNT/LEDGE KITCHEN FAUCETS

	Model#	Description	Finish	Case	Price
	 	0046-LE0 Two Handle Wallmount Kitchen Faucet 2-3/8" Lever Handles 6" Tube Swivel Spout 1/2-14 NPS Male Thread Quick-Presson Quarter-Turn Stems, Replaceable Seats 2-Hole 8" Installation Brass Soap Dish 1.5 GPM Flow Rate	Polished Chrome	6	\$238.00
		 	0048-TLE0 Two Handle Wallmount Kitchen Faucet 2-3/8" Lever Handles 6" Tube Swivel Spout 1/2-14 NPT Male Thread Quick-Presson Quarter-Turn Stems, Replaceable Seats 2-Hole 7-7/8" to 8-1/8" Installation Brass Soap Dish 1.5 GPM Flow Rate	Polished Chrome	6
0048-TA		Canopy Handles	Polished Chrome	6	\$130.00
80048-TA		Ceramic Disc Cartridges, Canopy Handles	Polished Chrome	6	\$140.50
0048-SLE0		Same as 0048 with 1/2-14 NPS Female Thread 2-Hole 6-1/2 to 9-1/2 Installation 2-3/8" Lever Handles	Polished Chrome	6	\$145.00
0048-SA		Canopy Handles	Polished Chrome	6	\$142.00
0048-UA		Same as 0048 with 1/2-14 NPS Female Thread 2-Hole 7 7/8" to 8 1/8" Installation	Polished Chrome	6	\$140.00
80048-UA		Ceramic Disc Cartridges, Canopy Handles	Polished Chrome	6	\$150.50
	 	0048-ULE0 Two Handle Wallmount Kitchen Faucet 2-3/8" Lever Handles 6" Tube Swivel Spout 1/2-14 NPS Female Thread Quick-Presson Quarter-Turn Stems, Replaceable Seats 2-Hole 7-7/8" to 8-1/8" Installation Brass Soap Dish 1.5 GPM Flow Rate	Polished Chrome	6	\$143.00
	0048-UA3	Canopy Handles	Polished Chrome	6	\$155.00
Suffix #	1	8-Inch Tube Spout with Aerator (SU-363-RA)		---	\$9.00
	2	10-Inch Tube Spout with Aerator (SU-363-JA)		---	\$14.00
	3	12-Inch Tube Spout with Aerator (SU-363-LA)		---	\$15.00
	4	14-Inch Tube Spout with Aerator (SU-363-MA)		---	\$15.50
	6	8-Inch Brass D-Spout with Aerator (SU-365-CA)		---	\$16.00
	9	5-Inch Cast Brass Spout with Aerator (SU-2923-A)		---	\$21.30
	H	Hose Adapter (PF-784-C)		---	\$1.30
	ELS	4-Inch Wrist Handles (G-4147-C,H) Color-coded Indexes		---	\$25.80
	EL	6-Inch Elbow Handles (G-4149-C,H) Color-coded Indexes		---	\$31.00
	Q	Quarter-Turn Stems (G-454-EL,ER)		---	\$1.80
	E1.0	1.0 GPM Flow Rate (CS-49011-Male Aerator/CS-49012-Female Aerator)		---	\$4.00
	E0.5	0.5 GPM Flow Rate (CS-49009-Male Aerator/CS-49010-Female Aerator)		---	\$9.50

Central Brass faucets feature aerators that meet ANSI/ASME A112.18.1 flow requirements of 1.5 GPM

KITCHEN // Pot Fillers





POT FILLERS

	Model#	Description	Finish	Case	Price
	0398-ULE0	Wall Mount Pot Filler 2-3/8" Lever Handle 6" Reach Tube Swivel Spout 1/2-14 NPT Female Thread Quick-Pression Quarter-Turn Stem, Replaceable Seat 1-Hole Installation Designed for Cold Water 1.5 GPM Flow Rate	Polished Chrome	6	\$79.00
	0398-ULEEX0	Wall Mount Pot Filler 2-3/8" Lever Handle 6" Reach Tube Swivel Spout W/Double-Joint 7" Spout Extension 1/2-14 NPT Female Thread Quick-Pression Quarter-Turn Stem, Replaceable Seat 1-Hole Installation Designed for Cold Water 1.5 GPM Flow Rate	Polished Chrome	6	\$94.00
Suffix #					
	1	8" Swivel Tube Spout with Aerator (SU-363-RA)		---	\$9.00
	2	10" Swivel Tube Spout with Aerator (SU-363-JA)		---	\$14.00
	3	12" Swivel Tube Spout with Aerator (SU-363-LA)		---	\$15.00
	4	14" Swivel Tube Spout with Aerator (SU-363-MA)		---	\$15.50
	6	8" Brass Swivel D-Spout with Aerator (SU-365-CA)		---	\$16.00
	07	8-3/4" Swivel Gooseneck Spout with Aerator (SU-357-WSA)		---	\$32.30
	8	7-1/4" High-Rise Spout with Aerator (SU-357-HSA)		---	\$43.30
	9	5" Cast Brass Spout With Aerator (SU-2923-A)		---	\$21.30
	13	16" Swivel Tube Spout With Aerator (CS-22004)		---	\$16.00
	17	4-3/32" Rigid/Swivel Combo Gooseneck Spout With Aerator (CS-22002)		---	\$15.50
	18	5-1/2" Rigid/Swivel Combo Gooseneck Spout With Aerator (CS-22003)		---	\$35.30
	23	18" Swivel Tube Spout With Aerator (CS-22005)		---	\$16.50
	EX	7" Cast Brass Spout Extension (SU-2775-R-02)		---	\$15.00
	F	Full Flow Streamer (CS-49029)		---	\$3.00

Central Brass faucets feature aerators that meet ANSI/ASME A112.18.1 flow requirements of 1.5 GPM

SERVICE SINKS // Faucets



SERVICE SINK FAUCETS

	Model#	Description	Finish	Case	Price
	0050-ULERC	Two Handle Wallmount Service Sink Faucet 2-3/8" Lever Handles 2-1/2" Rigid Spout With Pail Hook, Hose Thread 1/2-14 NPS Female Thread Quarter-Turn Stems with Backflow Preventers 2-Hole 7-7/8" to 8-1/8" Installation Vacuum Breaker	Rough Chrome	6	\$156.50
	0050-URC	Canopy Handles	Rough Chrome	6	\$153.50
	0050-URC-QI	Two Handle Wallmount Service Sink Faucet Canopy Handles With Color Coded Indexes 2-1/2" Rigid Spout With Pail Hook, Hose Thread 1/2-14 NPS Female Thread Quarter-Turn Stems with Backflow Preventers Built-in Stops 2-Hole 7-7/8" to 8-1/8" Installation Vacuum Breaker	Rough Chrome	6	\$176.00
	80050-U-I	Ceramic Disc Cartridges	Polished Chrome	6	\$233.10
	0051-URC	Two Handle Wallmount Service Sink Faucet Canopy Handles 2-1/2" Rigid Spout With Pail Hook, Hose Thread 1/2-14 NPS Female Thread Quarter-Turn Stems with Backflow Preventers 2-Hole 7-7/8" to 8-1/8" Installation	Rough Chrome	6	\$126.50
	0054-ULE-Q	Two Handle Wallmount Service Sink Faucet 2-3/8" Lever Handles 5-3/4" Rigid Spout With Pail Hook And Top Brace to Wall With Flange, Hose Thread 1/2-14 NPS Female Thread Quarter-Turn Stems with Backflow Preventers Built-in Stops 2-Hole 7-7/8" to 8-1/8" Installation Vacuum Breaker	Polished Chrome	6	\$193.00
	0054-ULE-QI	Built in Stops	Polished Chrome	6	\$238.00
	0054-U-QI	Canopy Handles	Polished Chrome	6	\$235.00
	0054-URC-QI	Canopy Handles	Rough Chrome	6	\$182.00
	80054-U-I	Ceramic Disc Cartridges	Polished Chrome	6	\$245.50
	0054-U-Q	Two Handle Wallmount Service Sink Faucet Canopy Handles	Polished Chrome	6	\$190.00
	0054-URC-Q	5-3/4" Rigid Spout With Pail Hook And Top Brace to Wall With Flange, Hose Thread 1/2-14 NPS Female Thread Quarter-Turn Stems with Backflow Preventers 2-Hole 7-7/8" to 8-1/8" Installation Vacuum Breaker	Rough Chrome	6	\$169.00
Suffix #	ELS	4-Inch Wrist Handles (G-4147-C,H) Color-coded Indexes		---	\$25.80
	EL	6-Inch Elbow Handles (G-4149-C,H) Color-coded Indexes		---	\$31.00
	S	1/2-14 NPS Female Inlet Flanges (SU-2806) (Adjustable 6-1/2 to 9-1/2-Inch Centers)		---	\$15.50
	T	1/2-14 NPT Male Inlet Shank Flanges (SU-2846) (Adjustable 7-7/8 to 8-1/8-Inch Centers)		---	\$10.50
	YRC	1/2-14 NPS Female Inlet Flanges with Integral Stops (SU-2841-ARC) (Adjustable 3 to 13-Inch Centers)		---	\$46.00

Central Brass faucets feature aerators that meet ANSI/ASME A112.18.1 flow requirements of 1.5 GPM

SERVICE SINK // Faucets



SERVICE SINK FAUCETS

	Model#	Description	Finish	Case	Price
	CS-65002	Hose Bracket Stainless Steel Construction Spring Loaded Grip 30" Heavy Duty Rubber Hose With 3/4" Hose Thread Connection Mounting Hardware Included	Polished Chrome	6	\$44.60
	CS-65001	Stainless Steel Mop Hanger Stainless Steel Construction Spring Loaded Grips Mounting Hardware Included	Stainless Steel	6	\$60.50
Easy Install Adapter for Models: 0047, 0048, 0050, 0051, 0054.	CS-42002	Easy Install Adapter for Chicago Faucet to Central Brass		---	\$35.20
	CS-42003	Easy Install Adapter for T & S Faucet to Central Brass		---	\$31.80
	CS-42004	Easy Install Adapter for Fisher Faucet to Central Brass		---	\$39.80

Central Brass faucets feature aerators that meet ANSI/ASME A112.18.1 flow requirements of 1.5 GPM

BAR // Glass Fillers

GLASS FILLERS

	Model#	Description	Finish	Case	Price
	✓ 0393	Glass Filler Push Button Type 2-1/2" Gooseneck Rigid Spout 3/8-18 NPS Female Thread 1-Hole Installation	Polished Chrome	6	\$82.00
	✓ 0396	Glass Filler Push Back Type 3/8-18 NPT Male Inlet with Flange Adjustable Volume Control 1-Hole Installation 2.78 GPM @ 60 PSI	Polished Chrome	20	\$107.00
	✓ 0397	Glass Filler Push Back Type 1/2-14 NPS Male Inlet with Flange Adjustable Volume Control 1-Hole Installation 2.78 GPM @ 60 PSI	Polished Chrome	10	\$126.00

BAR // Single Handle Faucets











SINGLE BAR HANDLE FAUCETS

		Model#	Description	Finish	Case	Price
		0280-AC	Single Handle Bar Faucet Canopy Handle	Polished Chrome	6	\$107.00
		0280-AH	5" Cast Brass Spout 1/2-14 NPS Male inlet x 1-7/8" Long Quick-Pression Quarter-Turn Stem, Replaceable Seat 1-Hole Installation 1.5 GPM Flow Rate	Polished Chrome	6	\$107.00
		0280-AC17	Single Handle Bar Faucet Canopy Handle 4-3/32" Gooseneck Rigid/Swivel Spout 1/2-14 NPS Male inlet x 1-7/8" Long Quick-Pression Quarter-Turn Stem, Replaceable Seat 1-Hole Installation Cold Only 1.5 GPM Flow Rate	Polished Chrome	6	\$116.50
		0286-AC	Single Handle Bar Faucet Canopy Handle	Polished Chrome	6	\$80.50
		0286-AH	4-11/16" Gooseneck Rigid Spout	Polished Chrome	6	\$80.50
		80286-AC	1/2-14 NPS Male inlet x 1-7/8" Long Quick-Pression Quarter-Turn Stem, Replaceable Seat 1-Hole Installation 1.5 GPM Flow Rate	Polished Chrome	6	\$85.50
		0281-AC	Single Handle Bar Faucet Canopy Handle	Polished Chrome	6	\$92.50
		0281-AH	4-5/16" Gooseneck Rigid Spout 1/2-14 NPS Male inlet x 1-7/8" Long Quick-Pression Quarter-Turn Stem, Replaceable Seat 1-Hole Installation 1.5 GPM Flow Rate	Polished Chrome	6	\$92.50
		0282	Single Handle Dishwasher Faucet Canopy Handle 2-13/16" Rigid Spout 1/2-14 NPS Male inlet x 1-7/8" Long Quick-Pression Quarter-Turn Stem, Replaceable Seat 1-Hole Installation 1.5 GPM Flow Rate	Polished Chrome	6	\$82.80

Central Brass faucets feature aerators that meet ANSI/ASME A112.18.1 flow requirements of 1.5 GPM

BAR // Two Handle Faucets





TWO HANDLE BAR FAUCETS

		Model#	Description	Finish	Case	Price
		0284-A-Q	Two Handle Bar/Pantry Faucet Tear Drop Handles 5-1/8" Gooseneck Rigid Spout 1-1/16-14 NPS Male Thread Quick-Presson Quarter-Turn Stems, Replaceable Seats 1-Hole Installation Copper Supply Tubes 1.5 GPM Flow Rate	Polished Chrome	6	\$164.00
		0285-A-Q	Two Handle Bar/Pantry Faucet Tear Drop Handles 5-9/16" Gooseneck Swivel Spout 1-1/16-14 NPS Male Thread Quick-Presson Quarter-Turn Stems, Replaceable Seats 1-Hole Installation Copper Supply Tubes 1.5 GPM Flow Rate	Polished Chrome	6	\$178.00
		0287-LE17	Two Handle Bar/Pantry Faucet Canopy Handles 4-3/32" Gooseneck Rigid/Swivel Spout 1-1/16-14 NPS Male Thread Quick-Presson Quarter-Turn Stems, Replaceable Seats 1-Hole Installation Copper Supply Tubes 1.5 GPM Flow Rate	Polished Chrome	6	\$147.00
		0287-A17	Canopy Handles	Polished Chrome	6	\$147.00
		0287-LE18	5-1/2" Rigid/Swivel Spout	Polished Chrome	6	\$148.80
		0287-ELS17	Two Handle Bar/Pantry Faucet 4" Wrist Blade Handles with Color-Coded Indexes 4-3/32" Gooseneck Rigid/Swivel Spout 1-1/16-14 NPS Male Thread Quick-Presson Quarter-Turn Stems, Replaceable Seats 1-Hole Installation Copper Supply Tubes 1.5 GPM Flow Rate	Polished Chrome	6	\$174.60
		0289-A	Two Handle Bar Faucet Canopy Handles 3-15/16" Gooseneck Rigid Spout 1-1/16-14 NPS Male Thread Quick-Presson Quarter-Turn Stems, Replaceable Seats 1-Hole Installationz Copper Supply Tubes 1.5 GPM Flow Rate	Polished Chrome	6	\$135.00

BAR

BAR & LAUNDRY // Faucets







TWO HANDLE BAR & LAUNDRY FAUCETS

	Model#	Description	Finish	Case	Price
	0084-LE0	Two Handle Cast Brass Bar/Laundry Faucet 2-3/8" Lever Handles 6" Tube Swivel Spout Quick-Presson Quarter-Turn Stems, Replaceable Seats 2 or 3-Hole 4" Installation 1.5 GPM Flow Rate	Polished Chrome	6	\$99.00
	0084-A	Canopy Handles	Polished Chrome	6	\$96.00
	80084-A	Ceramic Disc Cartridges, Canopy Handles	Polished Chrome	6	\$106.50
	80084-AELS	Two Handle Cast Brass Bar/Laundry Faucet 4" Wrist Blade Handles with Color-Coded Indexes 6" Tube Swivel Spout Ceramic Disc Cartridges 2 or 3-Hole 4" Installation 1.5 GPM Flow Rate	Polished Chrome	6	\$132.30
	0094-ELS17	Two Handle Shell Type Bar/Laundry Faucet 4" Wrist Blade Handles with Color-Coded Indexes 4-3/32" Gooseneck Rigid/Swivel Spout Quick-Presson Quarter-Turn Stems, Replaceable Seats 2 or 3-Hole 4" Installation 1.5 GPM Flow Rate	Polished Chrome	6	\$126.30
	0094-LE0	Two Handle Shell Type Bar/Laundry Faucet 2-3/8" Lever Handles 6" Tube Swivel Spout Quick-Presson Quarter-Turn Stems, Replaceable Seats 2 or 3-Hole 4" Installation 1.5 GPM Flow Rate	Polished Chrome	6	\$88.00
	0094-A	Canopy Handles	Polished Chrome	6	\$85.00
Suffix #	1	8-Inch Tube Spout with Aerator (SU-363-RA)		---	\$9.00
	2	10-Inch Tube Spout with Aerator (SU-363-JA)		---	\$14.00
	3	12-Inch Tube Spout with Aerator (SU-363-LA)		---	\$15.00
	4	14-Inch Tube Spout with Aerator (SU-363-MA)		---	\$15.50
	6	8-Inch Brass D-Spout with Aerator (SU-365-CA)		---	\$16.00
	8	7-1/4-Inch High-rise Spout with Aerator (SU-357-HSA)		---	\$43.30
	17	4-3/32" Rigid/Swivel Combo Gooseneck Spout With Aerator (CS-22002)		---	\$15.50
	18	5-1/2" Rigid/Swivel Combo Gooseneck Spout With Aerator (CS-22003)		---	\$35.30
	H	Hose Adapter (PF-784-C)		---	\$1.30
	ELS	4-Inch Wrist Handles (G-4147-C,H) Color-coded Indexes		---	\$25.80
	EL	6-Inch Elbow Handles (G-4149-C,H) Color-coded Indexes		---	\$31.00
	Q	Quarter-Turn Stems (G-454-EL,ER)		---	\$1.80

Central Brass faucets feature aerators that meet ANSI/ASME A112.18.1 flow requirements of 1.5 GPM

BAR & LAUNDRY // Faucets













TWO HANDLE BAR & LAUNDRY FAUCETS

		Model#	Description	Finish	Case	Price
		0084-LE17	Two Handle Cast Brass Bar/Laundry Faucet 2-3/8" Lever Handles 4-3/32" Gooseneck Rigid/Swivel Spout Quick-Pression Quarter-Turn Stems, Replaceable Seats 2 or 3-Hole 4" Installation 1.5 GPM Flow Rate	Polished Chrome	6	\$114.50
		0084-A17	Canopy Handles	Polished Chrome	6	\$111.50
		80084-A17	Ceramic Disc Cartridges, Canopy Handles	Polished Chrome	6	\$122.00
		0084-EL17	Two Handle Cast Brass Bar/Laundry Faucet 6" Elbow Handles with Color-Coded Indexes 4-3/32" Gooseneck Rigid/Swivel Spout Quick-Pression Quarter-Turn Stems, Replaceable Seats 2 or 3-Hole 4" Installation 1.5 GPM Flow Rate	Polished Chrome	6	\$142.50
		0084-ELS17	Two Handle Cast Brass Bar/Laundry Faucet 4" Wrist Blade Handles with Color-Coded Indexes 4-3/32" Gooseneck Rigid/Swivel Spout Quick-Pression Quarter-Turn Stems, Replaceable Seats 2 or 3-Hole 4" Installation 1.5 GPM Flow Rate	Polished Chrome	6	\$137.30
		80084-ELS17	Ceramic Disc Cartridge	Polished Chrome	6	\$147.80
		0084-ELS17-E0.5	0.5 GPM Flow Rate	Polished Chrome	6	\$148.60

Central Brass faucets feature aerators that meet ANSI/ASME A112.18.1 flow requirements of 1.5 GPM

LAUNDRY // Faucets



TWO HANDLE LAUNDRY FAUCETS

	Model#	Description	Finish	Case	Price
	 0465-LE	Two Handle Laundry Faucet 2-3/8" Lever Handles	Rough Brass	6	\$77.75
	0465*	6" Tube Swivel Spout, Hose Thread 1/2" IP or copper Sweat Union Inlets	Rough Brass	6	\$74.75
	80465**	3-1/2" Centers Quick-Pression Quarter-Turn Stems, Replaceable Seats Straddle Legs *Lever Handles **Ceramic Disc Cartridges	Rough Brass	6	\$85.25
	 0466	Two Handle Laundry Faucet Lever Handles	Rough Brass	6	\$64.00
	80466*	6" Tube Swivel Spout, Hose Thread Direct Sweat Inlets 3-1/2" Centers Quick-Pression Quarter-Turn Stems, Replaceable Seats Straddle Legs *Ceramic Disc Cartridges	Rough Brass	6	\$74.50
	 0468	Two Handle Laundry Faucet Lever Handles 6" Tube Swivel Spout, Hose Thread 1/2" IP or copper Sweat Union Inlets 3-1/2" Centers Quick-Pression Quarter-Turn Stems, Replaceable Seats Extended Straddle Legs	Rough Brass	6	\$95.50
	 0469	Two Handle Laundry Faucet Lever Handles 6" Tube Swivel Spout, Hose Thread 1/2" IP or copper Sweat Union Inlets 3-1/2" Centers Quick-Pression Quarter-Turn Stems, Replaceable Seats Extended Hole Mount Legs	Rough Brass	6	\$102.50
	 0470	Two Handle Laundry Faucet Lever Handles 6" Tube Swivel Spout, Hose Thread 1/2" IP or copper Sweat Union Inlets 3-1/2" Centers Quick-Pression Quarter-Turn Stems, Replaceable Seats Offset Legs For Wallmount	Rough Brass	6	\$96.50
Suffix #	5	6-Inch Cast Spout with Hose End (SU-2929-01) Rough Brass		---	\$9.00
	0471-RC	Two Handle Laundry Faucet 4-Arm Handle 4-1/2" Swivel Spout, Hose Thread 1/2" IP or copper Sweat Union Inlets Quick-Pression Quarter-Turn Stems, Replaceable Seats 6" Centers	Rough Chrome	6	\$150.50
	0455	Wash Machine Filler Canopy Handles 1/2" IP or copper Sweat Union Inlets Replaceable Seats 8" Centers	Polished Chrome	8	\$116.50

Central Brass faucets feature aerators that meet ANSI/ASME A112.18.1 flow requirements of 1.5 GPM

WORKBOARD SINK // Faucets













WORKBOARD SINK FAUCETS

	Model#	Description	Finish	Case	Price
	0184-LE0	Two Handle Cast Brass Wallmount Faucet 2-3/8" Lever Handle 6" Tube Swivel Spout Quick-Pression Quarter-Turn Stems, Replaceable Seats 2-Hole 4" Installation 1.5 GPM Flow Rate	Polished Chrome	6	\$103.00
	0194-LE0	Two Handle Shell Type Wallmount Faucet 2-3/8" Lever Handle 6" Tube Swivel Spout Quick-Pression Quarter-Turn Stems, Replaceable Seats 2-Hole 4" Installation 1.5 GPM Flow Rate	Polished Chrome	6	\$92.00
Suffix #					
	1	8" Tube Swivel Spout with Aerator (SU-363-RA)		---	\$9.00
	2	10" Tube Swivel Spout with Aerator (SU-363-JA)		---	\$14.00
	3	12" Tube Swivel Spout with Aerator (SU-363-LA)		---	\$15.00
	4	14" Tube Swivel Spout with Aerator (SU-363-MA)		---	\$15.50
	6	8" Brass Swivel D-Spout with Aerator (SU-365-CA)		---	\$16.00
	07	8-3/4" High-Rise Swivel Gooseneck Spout with Aerator (SU-357-WSA)		---	\$32.30
	8	7-1/4" High-Rise Spout with Aerator (SU-357-HSA)		---	\$43.30
	9	5" Cast Brass Spout With Aerator (SU-2923-A)		---	\$21.30
	13	16" Tube Swivel Spout With Aerator (CS-22004)		---	\$16.00
	17	4-3/32" Rigid/Swivel Combo Gooseneck Spout With Aerator (CS-22002)		---	\$15.50
	18	5-1/2" Rigid/Swivel Combo Gooseneck Spout With Aerator (CS-22003)		---	\$35.30
	23	18" Tube Swivel Spout With Aerator (CS-22005)		---	\$16.50
	EX	7" Cast Brass Spout Extension (SU-2775-R-02)		---	\$15.00

Central Brass faucets feature aerators that meet ANSI/ASME A112.18.1 flow requirements of 1.5 GPM

LAVATORY // Two Handle Faucets















TWO HANDLE LAVATORY FAUCETS

	Model#	Description	Finish	Case	Price
	  	1137-LE Two Handle Lavatory Faucet 2-3/8" Lever Handles Quick-Pression Quarter-Turn Stems, Replaceable Seats 3-Hole 4" Installation With Hole Cover 1.2 GPM Flow Rate	Polished Chrome	6	\$115.00
		1137-DLE Brass Pop-Up Drain Assembly	Polished Chrome	6	\$147.00
		1137-A Canopy Handles	Polished Chrome	6	\$112.00
		81137-A Ceramic Disc Cartridges, Canopy Handles	Polished Chrome	6	\$122.50
		1137-DA Two Handle Lavatory Faucet Canopy Handles Quick-Pression Quarter-Turn Stems, Replaceable Seats 3-Hole 4" Installation Brass Pop-Up Drain Assembly 1.2 GPM Flow Rate	Polished Chrome	6	\$144.00
		81137-DA Ceramic Disc Cartridges, Canopy Handles	Polished Chrome	6	\$154.50
		1137-DAEL Two Handle Lavatory Faucet 6" Elbow Handles with Color-Coded Indexes Quick-Pression Quarter-Turn Stems, Replaceable Seats 3-Hole 4" Installation Brass Pop-Up Drain Assembly 1.2 GPM Flow Rate	Polished Chrome	6	\$175.00
	  	1137-AELS Two Handle Lavatory Faucet 4" Wrist Blade Handles with Color-Coded Indexes Quick-Pression Quarter-Turn Stems, Replaceable Seats 3-Hole 4" Installation 1.2 GPM Flow Rate	Polished Chrome	6	\$132.00
		81137-AELS Ceramic Disc Cartridges	Polished Chrome	6	\$142.50
		1137-DAELS Two Handle Lavatory Faucet 4" Wrist Blade Handles with Color-Coded Indexes Quick-Pression Quarter-Turn Stems, Replaceable Seats 3-Hole 4" Installation Brass Pop-Up Drain Assembly 1.2 GPM Flow Rate	Polished Chrome	6	\$164.00
		81137-DAELS Ceramic Disc Cartridges	Polished Chrome	6	\$174.50
Suffix #	Q	Quarter-Turn Stems (G-454-EL,ER)		- - -	\$1.80
	  	1138-LE Two Handle Lavatory Faucet 2-3/8" Lever Handles Chain & Stopper Quick-Pression Quarter-Turn Stems, Replaceable Seats 3-Hole 4" Installation No Lift Rod Hole 1.2 GPM Flow Rate	Polished Chrome	6	\$122.00
		1138-A Canopy Handles	Polished Chrome	6	\$119.00

Central Brass faucets feature aerators that meet ANSI/ASME A112.18.1 flow requirements of 1.5 GPM

LAVATORY // Two Handle Faucets







TWO HANDLE LAVATORY FAUCETS

	Model#	Description	Finish	Case	Price
	  	1133-LE Two Handle Lavatory Faucet 2-3/8" Lever Handles 4-5/8" Extended Spout Quick-Pression Quarter-Turn Stems, Replaceable Seats 3-Hole 4" Installation 1.2 GPM Flow Rate	Polished Chrome	6	\$116.50
		1133-DLE Brass Pop-Up Drain Assembly	Polished Chrome	6	\$148.00
		1133-A Canopy Handles	Polished Chrome	6	\$113.50
		1167-AV Self-Close Two Handle Lavatory Faucet Vandal-Resistant Lever Handles Replaceable Seats 3-Hole 4" Installation 1.2 GPM Flow Rate	Polished Chrome	6	\$249.10
	 	3137-AN2 Slow-Close Two Handle Lavatory Faucet Push Handles	Polished Chrome	6	\$206.00
		3137-AVN2* 3-Hole 4" Installation 1.2 GPM Flow Rate *Vandal Resistant 0.5 GPM Flow Rate Note: New ADA Compliant Cartridge and Handle Kit (CS-49016C,H,P) Fits Old/New Slow Close Faucets.	Polished Chrome	6	\$209.00
		3137-DAN2 Slow-Close Two Handle Lavatory Faucet Push Handles 3-Hole 4" Installation Brass Pop-Up Drain Assembly 1.2 GPM Flow Rate *Vandal Resistant 0.5 GPM Flow Rate Note: New ADA Compliant Cartridge and Handle Kit (CS-49016C,H,P) Fits Old/New Slow Close Faucets.	Polished Chrome	6	\$238.00
	 	1177-LE Two Handle Shelf Back Lavatory Faucet 2-3/8" Lever Handle Replaceable Seats	Polished Chrome	6	\$137.30
		1177-DLE 3-Hole 4" to 6" Installation 1.2 GPM Flow Rate	Polished Chrome	6	\$169.30
		1177-A* Brass Pop-Up Drain Assembly	Polished Chrome	6	\$134.30
		1177-AV* Brass Pop-Up Drain Assembly	Polished Chrome	6	\$137.30
		1177-DA* *Canopy Handles	Polished Chrome	6	\$166.30
	 	1178-LE Two Handle Slant Back Lavatory Faucet 2-3/8" Lever Handle	Polished Chrome	6	\$171.50
		1178-DLE 45-Degree Slant Back Spout Replaceable Seats	Polished Chrome	6	\$202.50
		1178-A* 3-Hole 4" to 6" Installation 1.2 GPM Flow Rate	Polished Chrome	6	\$167.50
		1178-DA* Brass Pop-Up Drain Assembly *Canopy Handles	Polished Chrome	6	\$199.50

Central Brass faucets feature aerators that meet ANSI/ASME A112.18.1 flow requirements of 1.5 GPM

LAVATORY // Two Handle Faucets



TWO HANDLE LAVATORY FAUCETS

	Model#	Description	Finish	Case	Price
	 1125-A	Two Handle Widespread Lavatory Faucet Round Metal Handles 4-1/2" Low Profile Spout	Polished Chrome	6	\$149.00
	81125-A*	Flexible Hose Connections Quick-Pression Quarter-Turn Stems, Replaceable Seats 3-Hole 6" to 24" Installation With Hole Cover 1.2 GPM Flow Rate *Ceramic Disc Cartridges	Polished Chrome	6	\$159.50
	1125-DA	Two Handle Widespread Lavatory Faucet Round Metal Handles 4-1/2" Low Profile Spout	Polished Chrome	6	\$179.00
	81125-DA*	Flexible Hose Connections Quick-Pression Quarter-Turn Stems, Replaceable Seats 3-Hole 6" to 24" Installation Brass Pop-Up Drain Assembly 1.2 GPM Flow Rate *Ceramic Disc Cartridges	Polished Chrome	6	\$189.50
	 1172-11AELS-Q	Two Handle Widespread Lavatory Faucet 4" Wrist Blade Handles with Color-Coded Indexes 4-1/2" Low Profile Spout Flexible Hose Connections Quick-Pression Quarter-Turn Stems, Replaceable Seats Replaceable Seats 3-Hole 6" to 24" Installation 1.2 GPM Flow Rate	Polished Chrome	6	\$198.00
	 81172-D12AL1	Two Handle Widespread Lavatory Faucet Lever Handles	Polished Chrome	6	\$292.50
	81172-D12AL1-BN	5-7/16" 'C' Style Spout Flexible Hose Connections Ceramic Disc Cartridges 3-Hole 6" to 24" Installation Brass Pop-Up Drain Assembly 1.2 GPM Flow Rate	PVD Brushed Nickel	6	\$350.50

Central Brass faucets feature aerators that meet ANSI/ASME A112.18.1 flow requirements of 1.5 GPM

LAVATORY // Two Handle Faucets





TWO HANDLE LAVATORY FAUCETS

	Model#	Description	Finish	Case	Price
	  3127-AN1	Slow-Close Two Handle Widespread Lavatory Faucet Push Handles	Polished Chrome	6	\$270.00
	3127-AVN1*	4-1/2" Low Profile Spout Flexible Hose Connections 3-Hole 6" to 24" Installation No Lift Rod Hole 1.2 GPM Flow Rate *Vandal Resistant 0.5 GPM Flow Rate Note: New ADA Compliant Cartridge and Handle Kit (CS-49017C,H,P) Fits Old/New Slow Close Faucets.	Polished Chrome	6	\$273.00

Central Brass faucets feature aerators that meet ANSI/ASME A112.18.1 flow requirements of 1.5 GPM

LAVATORY // Single Basin Faucets





SINGLE BASIN LAVATORY FAUCETS

	Model#	Description	Finish	Case	Price
	✓ 0239-P	Single Handle Basin Faucet 4-Arm Handle With Optional Red/Blue Indexes	Polished Chrome	6	\$49.50
	0239-AP*	Plain End 1/2-14 NPS Male Inlet x 2-1/4" Long Replaceable Seat 1-Hole Installation *1.2 GPM Flow Rate	Polished Chrome	6	\$53.50
	✓ 0255-C	Self-Close Single Handle Basin Faucet 4-Arm Handle	Polished Chrome	6	\$73.40
	0255-P	Plain End	Polished Chrome	6	\$73.40
	0255-H	1/2-14 NPS Male Inlet x 2-1/4" Long	Polished Chrome	6	\$73.40
	0255-AC*	Replaceable Seat	Polished Chrome	6	\$80.50
	0255-AP*	1-Hole Installation	Polished Chrome	6	\$80.50
	0255-AH*	*1.2 GPM Flow Rate	Polished Chrome	6	\$80.50
Suffix #	V	Vandal-Resistant Cap (0255 and 0255-A Only)	Polished Chrome	- - -	\$3.30
	✓ 0355-AN2C	Slow-Close Single Handle Basin Faucet Push Handle	Polished Chrome	6	\$114.50
	0355-AN2P	1/2-14 NPS Male Inlet x 2-1/4" Long	Polished Chrome	6	\$114.50
	0355-AN2H	1-Hole Installation	Polished Chrome	6	\$114.50
	0355-AVN2C*	1.2 GPM Flow Rate	Polished Chrome	6	\$117.50
	0355-AVN2P*	*Vandal Resistant 0.5 GPM Flow Rate Note: New ADA Compliant Cartridge and Handle Kit (CS-49016C,H,P) Fits Old/New Slow Close Faucets.	Polished Chrome	6	\$117.50
	✓ 0356-AN2C	Deluxe Slow-Close Single Handle Basin Faucet Push Handle	Polished Chrome	6	\$136.00
	0356-AN2P	1/2-14 NPS Male Inlet x 2-1/4" Long 1-Hole Installation 1.2 GPM Flow Rate *Vandal Resistant 0.5 GPM Flow Rate Note: New ADA Compliant Cartridge and Handle Kit (CS-49016C,H,P) Fits Old/New Slow Close Faucets.	Polished Chrome	6	\$136.00

Central Brass faucets feature aerators that meet ANSI/ASME A112.18.1 flow requirements of 1.5 GPM

TUB & SHOWER // Sets

TUB & SHOWER SETS





	Model#	Description	Finish	Case	Price
	80805	Two Handle Vavle Set Canopy Handles Ceramic Disc Cartridges 1/2" CXC Inlets 8" Centers Built-in Transfer Valve, Brass Plug Included	Polished Chrome	8	\$101.25
	8088-Z	Two Handle Tub Set Canopy Handles Replaceable Seats 1/2" CXC Inlets 8" Centers 1/2" IPS & Slip-on Combo Tub Spout Built-in Transfer Valve, Brass Plug Included	Polished Chrome	8	\$108.40
	80826	Two Handle Shower Set Canopy Handles Replaceable Seats Shower Head, Arm & Flange 1/2" CXC Inlets 8" Centers Built-in Transfer Valve, Brass Plug Included	Polished Chrome	8	\$117.75
	80826	Same as 80826 with Ceramic Disc Cartridges	Polished Chrome	8	\$132.25
	80897 (Canopy Option Left)	Two Handle Tub & Shower Set Canopy Handles Replaceable Seats Shower Head, Arm & Flange 1/2" CXC Inlets 8" Centers 1/2" IPS & Slip-on Combo Diverter Tub Spout Built-in Transfer Valve	Polished Chrome	8	\$143.50
	80897	Same as 80897 with Ceramic Disc Cartridges	Polished Chrome	8	\$158.00
	80897-L3	Same as 80897 with Lever Handles	Polished Chrome	8	\$222.00
	80897-C3	Same as 80897 with Cross Handles	Polished Chrome	8	\$234.00

Tub & shower sets available in Brushed Nickel.
Call for pricing and availability.

Central Brass showerheads meet ANSI/ASME A112.18.1 flow requirements of maximum 2.5 GPM

TUB & SHOWER // Sets

TUB & SHOWER SETS



	Model#	Description	Finish	Case	Price
	0850	Three Handle Valve Set Canopy Handles Replaceable Seats 1/2" CXC Inlets 8" Centers	Polished Chrome	8	\$108.75
	80850	Same as 0850 with Ceramic Disc Cartridges	Polished Chrome	8	\$123.25
	0868	Three Handle Tub & Shower Set Canopy Handles Shower Head, Arm & Flange 1/2" CXC Inlets Replaceable Seats 8" Centers 1/2" IPS Brass Tub Spout	Polished Chrome	8	\$190.80
	0868-Z	With 1/2" IPS & Slip-on Combo Tub Spout	Polished Chrome	8	\$160.25
	80868	Same as 0868 with Ceramic Disc Cartridges	Polished Chrome	8	\$205.30
	80868-Z	Same as 80868 W/ 1/2" IPS & Slip-on Combo Tub Spout	Polished Chrome	8	\$174.75
	 80868-L3 (Lever Option Left)	Same as 80868 with Lever Handles	Polished Chrome	8	\$296.00
80868-C3	Same as 80868 with Cross Handles	Polished Chrome	8	\$314.50	
	0905	Two Handle Valve Set Canopy Handles 1/2" IP or copper Sweat Union Inlets Replaceable Seats 8" Centers Built-in Transfer Valve, Brass Plug Included	Polished Chrome	8	\$95.25
	80905	Same as 0905 with Ceramic Disc Cartridges	Polished Chrome	8	\$109.75
	0908-Z	Two Handle Tub Set Canopy Handles 1/2" IP or copper Sweat Union Inlets Replaceable Seats 8" Centers 1/2" IPS & Slip-on Combo Tub Spout Built-in Transfer Valve, Brass Plug Included	Polished Chrome	8	\$116.40
	0908	Same as 0908-Z with Cast Brass Tub Spout	Polished Chrome	8	\$146.40

Tub & shower sets available in Brushed Nickel.
Call for pricing and availability.

All L3 Lever Handles for Central Brass Tub & Showers are ADA Compliant
Central Brass showerheads meet ANSI/ASME A112.18.1 flow requirements of maximum 2.5 GPM

TUB & SHOWER // Sets

TUB & SHOWER SETS









	Model#	Description	Finish	Case	Price
	0926	Two Handle Shower Set Canopy Handles Shower Head, Arm & Flange 1/2" IP or copper Sweat Union Inlets Replaceable Seats 8" Centers Built-in Transfer Valve, Brass Plug Included	Polished Chrome	8	\$126.25
	80926	Same as 0926 with Ceramic Disc Cartridges	Polished Chrome	8	\$140.75
	0997	Two Handle Tub & Shower Set Canopy Handles Shower Head, Arm & Flange 1/2" IP or copper Sweat Union Inlets Replaceable Seats 8" Centers 1/2" IPS & Slip-on Combo Diverter Tub Spout Built-in Transfer Valve	Polished Chrome	8	\$152.00
	80997	Same as 0997 with Ceramic Disc Cartridges	Polished Chrome	8	\$166.50

Tub & shower sets available in Brushed Nickel.
Call for pricing and availability.

Central Brass showerheads meet ANSI/ASME A112.18.1 flow requirements of maximum 2.5 GPM





TUB & SHOWER // Sets

TUB & SHOWER SETS

	Model#	Description	Finish	Case	Price
	0950	Three Handle Valve Set Canopy Handles 1/2" IP or copper Sweat Union Inlets Replaceable Seats 8" Centers	Polished Chrome	8	\$116.75
	80950	Same as 0950 with Ceramic Disc Cartridges	Polished Chrome	8	\$131.25
  	0968	Three Handle Tub & Shower Set Canopy Handles Shower Head, Arm & Flange 1/2" IP or copper Sweat Union Inlets Replaceable Seats 8" Centers 1/2" IPS Brass Tub Spout	Polished Chrome	8	\$197.90
	0968-Z	With 1/2" IPS & Slip-on Combo Tub Spout	Polished Chrome	8	\$168.25
	80968	Same as 0968 with Ceramic Disc Cartridges	Polished Chrome	8	\$212.40
	80968-Z	Same as 80968 W/ 1/2" IPS & Slip-on Combo Tub Spout	Polished Chrome	8	\$182.75
	0951	Three Handle Valve Set Canopy Handles 1/2" IP or copper Sweat Union Inlets Replaceable Seats 11" Centers	Polished Chrome	8	\$147.25
 	0961	Three Handle Tub Set Canopy Handles 1/2" IP or copper Sweat Union Inlets Replaceable Seats 11" Centers 1/2" IPS Brass Tub Spout	Polished Chrome	8	\$196.80
	0961-Z	With 1/2" IPS & Slip-on Combo Tub Spout	Polished Chrome	8	\$166.80
  	0971	Three Handle Tub & Shower Set Canopy Handles Shower Head, Arm & Flange 1/2" IP or copper Sweat Union Inlets Replaceable Seats 11" Centers 1/2" IPS Brass Tub Spout	Polished Chrome	8	\$228.00
	0971-Z	With 1/2" IPS & Slip-on Combo Tub Spout	Polished Chrome	8	\$198.00
	80971	Same as 0971 with Ceramic Disc Cartridges	Polished Chrome	8	\$242.50
	80971-Z	Same as 80971 W/ 1/2" IPS & Slip-on Combo Tub Spout	Polished Chrome	8	\$212.50

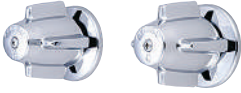
TUB & SHOWER // Sets

TUB & SHOWER SETS

	Model#	Description	Finish	Case	Price
	6056	Two Handle Valve Set Canopy Handles 1/2" IP or copper Sweat Union Inlets Replaceable Seats 6" Centers Built-in Transfer Valve, Brass Plug Included	Polished Chrome	8	\$86.50
	6086-Z	Two Handle Tub Set Canopy Handles 1/2" IP or copper Sweat Union Inlets Replaceable Seats 6" Centers 1/2" IPS & Slip-on Combo Tub Spout Built-in Transfer Valve, Brass Plug Included	Polished Chrome	8	\$106.75
	6266	Two Handle Shower Set Canopy Handles Shower Head, Arm & Flange 1/2" IP or copper Sweat Union Inlets Replaceable Seats 6" Centers Built-in Transfer Valve, Brass Plug Included	Polished Chrome	8	\$117.25
	6076	Two Handle Tub & Shower Set Canopy Handles Shower Head, Arm & Flange 1/2" IP or copper Sweat Union Inlets Replaceable Seats 6" Centers 1/2" IPS & Slip-on Combo Diverter Tub Spout Built-in Transfer Valve	Polished Chrome	8	\$143.00

Tub & shower sets available in Brushed Nickel.
Call for pricing and availability.

Central Brass showerheads meet ANSI/ASME A112.18.1 flow requirements of maximum 2.5 GPM

TUB & SHOWER // Trim Kits

TUB & SHOWER TRIM KITS



Canopy Handle

Cross Handle (C3)







Lever Handle (L3)

	Model#	Description	Finish	Case	Price
	TC-2 (Canopy Option Left)	Two Handle Tub And Shower Trim Kit Canopy Handles & Escutcheons Shower Head, Arm & Flange	Polished Chrome	6	\$51.10
	TC-2-BN	1/2" IPS Slip-on Combo Diverter Tub Spout	PVD Brushed Nickel	6	\$83.30
	TCR-2*	*With repair kits K-3-CT	Polished Chrome	6	\$61.10
	TCR-2-BN*		PVD Brushed Nickel	6	\$93.30
	TC-2-L3 (Lever Option Left)	Same as TC-2 with Lever Handles, Dual Function Shower Head, Cuttable Corner Stems & Nipples	Polished Chrome	6	\$180.30
	TC-2-L3-BN		PVD Brushed Nickel	6	\$188.00
	TC-2-C3	Same as TC-2 with Cross Handles, Dual Function Shower Head, Cuttable Corner Stems & Nipples	Polished Chrome	6	\$193.70
	TC-2-C3-BN		PVD Brushed Nickel	6	\$200.70
	TC-3 (Canopy Option Left)	Three Handle Tub And Shower Trim Kit Canopy Handles & Escutcheons Shower Head, Arm & Flange	Polished Chrome	6	\$68.70
	TC-3-BN	1/2" IPS & Slip-on Combo Tub Spout	PVD Brushed Nickel	6	\$103.70
	TCR-3*	*With repair kits K-3-CT / K-3-DT	Polished Chrome	6	\$78.70
	TCR-3-BN*		PVD Brushed Nickel	6	\$113.70

All L3 Lever Handles for Central Brass Tub & Showers are ADA Compliant
Central Brass showerheads meet ANSI/ASME A112.18.1 flow requirements of maximum 2.5 GPM

TUB & SHOWER // Trim Kits

TUB & SHOWER TRIM KITS



	Model#	Description	Finish	Case	Price	
	 TC-3-L3 (Lever Option Left) TC-3-L3-BN	Same as TC-3 with Lever Handles, Dual Function Shower Head, Cuttable Corner/ Diverter Stems & Nipples	Polished Chrome	6	\$229.80	
			PVD Brushed Nickel	6	\$232.20	
		TC-3-C3 TC-3-C3-BN	Same as TC-3 with Cross Handles, Dual Function Shower Head, Cuttable Corner/ Diverter Stems & Nipples	Polished Chrome	6	\$240.70
				PVD Brushed Nickel	6	\$251.45
		T-3 T-3-BN	Three Handle Trim Kit Canopy Handles & Escutcheons	Polished Chrome	6	\$48.30
				PVD Brushed Nickel	6	\$63.10
 T-3-L3 T-3-L3-BN		Same as T-3 with Lever Handles, Cuttable Corner/ Diverter Stems & Nipples	Polished Chrome	6	\$145.00	
			PVD Brushed Nickel	6	\$154.50	
		T-3-C3 (Cross Option Left) T-3-C3-BN	Same as T-3 with Cross Handles, Cuttable Corner/ Diverter Stems & Nipples	Polished Chrome	6	\$164.00
				PVD Brushed Nickel	6	\$173.00
		TR-3* TR-3-BN*	*With repair kits K-3-CT/ K-3-DT	Polished Chrome	6	\$58.30
		PVD Brushed Nickel		6	\$73.10	
	T-2 T-2-BN	Two Handle Trim Kit Canopy Handles & Escutcheons	Polished Chrome	6	\$28.60	
			PVD Brushed Nickel	6	\$39.50	
	 T-2-L3 (Lever Option Left) T-2-L3-BN	Same as T-2 with Lever Handles, Cuttable Corner Stems & Nipples	Polished Chrome	6	\$97.00	
			PVD Brushed Nickel	6	\$103.00	
		T-2-C3 T-2-C3-BN	Same as T-2 with Cross Handles, Cuttable Corner Stems & Nipples	Polished Chrome	6	\$109.00
				PVD Brushed Nickel	6	\$115.50
		TR-2* TR-2-BN*	*With repair kits K-3-CT	Polished Chrome	6	\$39.60
		PVD Brushed Nickel		6	\$49.50	

All L3 Lever Handles for Central Brass Tub & Showers are ADA Compliant
 Central Brass showerheads meet ANSI/ASME A112.18.1 flow requirements of maximum 2.5 GPM

TUB & SHOWER

TUB & SHOWER // Specialty Products

TUB & SHOWER SPECIALTY PRODUCTS

	Model#	Description	Finish	Case	Price
	1379	Two Handle Exposed Shower Set 4-Arm Handle 22-1/2" High Brass Riser Replaceable Seats 6" Centers Shower Head 1/2" IP or copper Sweat Union Inlets	Polished Chrome	6	\$218.00
	1379-L	Two Handle Exposed Valve Set 4-Arm Handle Replaceable Seats 6" Centers 1/2" IP or copper Sweat Union Inlets	Polished Chrome	6	\$152.00
	1380	Two Handle Exposed Shower Set 4-Arm Handle 22-1/2" High Brass Riser Replaceable Seats 8" Centers Shower Head 1/2" IP or copper Sweat Union Inlets	Polished Chrome	6	\$234.50
	1380-L	Two Handle Exposed Valve Set 4-Arm Handle Replaceable Seats 8" Centers 1/2" IP or copper Sweat Union Inlets	Polished Chrome	6	\$170.50

Central Brass showerheads meet ANSI/ASME A112.18.1 flow requirements of maximum 2.5 GPM

TUB & SHOWER // Specialty Products





TUB & SHOWER SPECIALTY PRODUCTS

	Model#	Description	Finish	Case	Price
	0477	Two Handle Utility Shower Lever Handles	Rough Brass	4	\$105.00
	0477-RC	22-1/2" High Galvanized Riser 1/2-14 NPSF (Dryseal) Female Inlets Shower Head and Soap Dish 3-1/2" Centers 1/2" IP or copper Sweat Union Inlets	Rough Chrome	4	\$110.00
	0206	Two Handle Leg Tub Faucet Canopy Handles 3/4-14 NPS Male Inlets Replaceable Seat 2-Hole 3-3/8" Installation	Polished Chrome	6	\$58.50
	0208	Two Handle Leg Tub Faucet Canopy Handles 6-7/8" High Gooseneck Spout 3/4-14 NPS Male Inlets Replaceable Seat 2-Hole 3-3/8" Installation	Polished Chrome	6	\$71.00
	0209	Two Handle Leg Tub Faucet Canopy Handles 8-1/2" High Gooseneck Spout 3/4-14 NPS Male Inlets Replaceable Seat 2-Hole 3-3/8" Installation	Polished Chrome	6	\$80.50

Central Brass faucets feature aerators that meet ANSI/ASME A112.18.1 flow requirements of 1.75 GPM



TUB & SHOWER // Specialty Products

TUB & SHOWER SPECIALTY PRODUCTS

	Model#	Description	Finish	Case	Price
	0210	Two Handle Leg Tub Faucet Round Metal Handles 3/4-14 NPS Male Inlets Replaceable Seat 2-Hole 3-3/8" Installation Adjustable Flanges	Polished Chrome	6	\$71.00
	0210-Q	Two Handle Leg Tub Faucet 4-Arm Handles 3/4-14 NPS Male Inlets Quarter-Turn Stems Replaceable Seat 2-Hole 3-3/8" Installation Adjustable Flanges	Polished Chrome	6	\$72.50
	0211	Two Handle Leg Tub Faucet Round Metal Handles 3/4-14 NPS Male Inlets Replaceable Seat 2-Hole 2-1/2" to 8-1/2" Installation	Polished Chrome	6	\$131.00
	0211-Q	Two Handle Leg Tub Faucet 4-Arm Handles 3/4-14 NPS Male Inlets Quarter-Turn Stems Replaceable Seat 2-Hole 2-1/2" to 8-1/2" Installation	Polished Chrome	6	\$132.50
	1240	Cast Brass Shower Valve Canopy Handles Single By-pass 1/2" IP or copper Sweat Union Inlets Replaceable Seats Threaded Escutcheon	Polished Chrome	6	\$97.50

TUB & SHOWER // Specialty Products

TUB & SHOWER SPECIALTY PRODUCTS

	Model#	Description	Finish	Case	Price
	1246	Cast Brass Shower Corner Valve Canopy Handles 1/2-14 NPSF (Dryseal) Female Inlets Replaceable Seats 1/2" IP or copper Sweat Union Inlets	Polished Chrome	6	\$93.50
	0334-1/2	Self-Close Shower Straight Stop Lever Handle 1/2-14 NPS Female Thread Replaceable Seat	Polished Chrome	6	\$70.00
	0335-1/2	Self-Close Shower Straight Stop Lever Handle With 18" Pull Chain 1/2-14 NPS Female Thread Replaceable Seat	Polished Chrome	6	\$72.40
Suffix #	V	Vandal-Resistant Cap		---	\$3.30

TUB & SHOWER // Bath Drains

TUB & SHOWER BATH DRAINS

	Model#	Description	Finish	Case	Price
	1645	Multi-Tub Centralift Lift & Turn Drain 20-Gauge 1-1/2" Drain Tubes Fits Most Tubs 14" To 16" High	Polished Chrome	6	\$97.60
	1645-17	Multi-Tub Centralift Lift & Turn Drain 17-Gauge 1-1/2" Drain Tubes Fits Most Tubs 14" To 16" High	Polished Chrome	6	\$108.00
	1645-CO	Multi-Tub Centralift Lift & Turn Drain Clean-out Ring Fits Most Tubs 14" To 16" High	Polished Chrome	6	\$108.00
	1645-PR	Multi-Tub Centralift Lift & Turn Drain Heavy Pattern Combination Tee (3364) One Additional Slip Nut (3008-BP) & Slip Washer (149-RP) Fits Most Tubs 14" To 16" High Less Tailpiece for Philadelphia Regulation	Polished Chrome	6	\$100.90
	1645-S	Multi-Tub Centralift Lift & Turn Drain With Side Outlet Drain Fits Most Tubs 14" To 16" High	Polished Chrome	6	\$125.90
	1675	Multi-Tub Pop-Up Bath Drain Fits Most Tubs 14" To 16" High	Polished Chrome	6	\$117.20









TUB & SHOWER // Bath Drains

TUB & SHOWER BATH DRAINS

	Model#	Description	Finish	Case	Price
	1675-S	Multi-Tub Pop-Up Bath Drain With Side Outlet Drain Fits Most Tubs 14" To 16" High	Polished Chrome	6	\$138.70
	1555	Multi-Tub Trip Lever Bath Drain Light Pattern Cast Brass Tee and Top Ell 20-Guage 1-1/2" Drain Tubes Fits Most Tubs 14" To 16" High	Polished Chrome	6	\$97.00
	1655	Multi-Tub Trip Lever Bath Drain Heavy Pattern Tee and Top Ell Fits Most Tubs 14" To 16" High	Polished Chrome	6	\$99.80
	1655-P	Multi-Tub Trip Lever Bath Drain Heavy Pattern Tee and Top Ell One Additional Slip Nut (3008-BP) & Slip Washer (149-RP) Fits Most Tubs 14" To 16" High Less Tailpiece for Philadelphia Regulation	Polished Chrome	6	\$99.80
	1655-X	Multi-Tub Trip Lever Bath Drain Heavy Pattern Tee and Top Ell Cast Brass Nuts (3008-X) Fits Most Tubs 14" To 16" High	Polished Chrome	6	\$103.80
	1655-X1817	Multi-Tub Trip Lever Bath Drain Heavy Pattern Tee and Top Ell 18" Overflow Tube & 9-9/16" Shoe Tube Cast Brass Nuts (3008-X) Fits Most Tubs Up To 24" High Fits Many 17-Gauge Whirlpool Tubs	Polished Chrome	6	\$122.70
	1665-WX	Multi-Tub Trip Lever Bath Drain Heavy Pattern Tee and Top Ell Plug Body with Brass Nuts With Weep Holes Fits Most Tubs 14" To 16" High	Polished Chrome	6	\$110.10
	1665-XP17	Multi-Tub Trip Lever Bath Drain Heavy Pattern Tee and Top Ell 17-Guage 1-1/2" Drain Tubes One Additional Slip Nut (3008-BP) & Slip Washer (149-RP) Fits Most Tubs 14" To 16" High Less Tailpiece for Philadelphia Regulation	Polished Chrome	6	\$127.60





TUB & SHOWER // Bath Drain Trim Kit

TUB & SHOWER BATH DRAIN TRIM KITS

	Model#	Description	Finish	Case	Price
	CS-66001	Trim Kit for 1645 Bath Drain Series	Polished Chrome	30	\$35.50
	CS-66001-BN		PVD Brushed Nickel	30	\$38.50
					
	CS-66002	Trim Kit for 1675 Bath Drain Series	Polished Chrome	30	\$37.00
	CS-66002-BN		PVD Brushed Nickel	30	\$39.50
					
	CS-66003	Trim Kit for 1555 and 1655 Bath Drain Series	Polished Chrome	30	\$31.50
	CS-66003-BN		PVD Brushed Nickel	30	\$33.50
					
	CS-66004	Trim Kit for 1665 Bath Drain Series	Polished Chrome	30	\$32.00
	CS-66004-BN		PVD Brushed Nickel	30	\$35.00
					

DRINKING FAUCETS // Bubbler Heads



DRINKING FAUCET / BUBBLER HEADS

	Model#	Description	Finish	Case	Price
	0364-L	Drinking Faucet Self-Close Lever Handle 1/2-14 NPS Male Thread Replaceable Seat	Polished Chrome	6	\$163.40
	0365-L	Drinking Faucet Self-Close Lever Handle 3/8-18 NPS Female Thread Replaceable Seat	Polished Chrome	6	\$158.50
	0366-L	Drinking Faucet-Wallmount Self-Close Lever Handle 3/8-18 NPS Female Thread Replaceable Seat	Polished Chrome	6	\$156.00
	0364-N2	Drinking Faucet Slow-Close Push Handle 1/2-14 NPS Male Thread	Polished Chrome	6	\$156.00
	V	Vandal-Resistant Cap (Available on 0364-L, 0365-L, and 0366-L)		---	\$3.30

DRINKING FAUCETS





DRINKING FAUCETS // Bubbler Heads

DRINKING FAUCET / BUBBLER HEADS

	Model#	Description	Finish	Case	Price
	0360	Drinking Faucet Cast Brass Bubbler Head 1/2-14 NPS Male Thread Replaceable Cartridge (K-361) Flange	Polished Chrome	6	\$89.30
	0361	Drinking Faucet Cast Brass Bubbler Head 3/8-18 NPS Female Thread Replaceable Cartridge (K-361) Flange	Polished Chrome	36	\$77.80
	0362	Drinking Faucet Cast Brass Bubbler Head 3/8-18 NPS Female Thread Replaceable Cartridge (K-361)	Polished Chrome	36	\$74.40





DRINKING FAUCETS // Bubbler Heads

DRINKING FAUCET / BUBBLER HEADS

	Model#	Description	Finish	Case	Price
	0366-HX8WB	Drinking Fountain-Wallmount Self-Close Lever Handle Brass Round Bowl, Brushed Finish 3/8-18 NPS Female Thread W/Wall Bracket Replaceable Seat	Polished Chrome	6	\$285.50
	0366-HX8WBD	0366-HX8WB with Drain Adapter 3/8" to 1-1/4"	Polished Chrome	6	\$307.00
	0366-HX8	Drinking Fountain-Wallmount Self-Close Lever Handle Brass Round Bowl, Brushed Finish 3/8-18 NPS Female Thread Replaceable Seat	Polished Chrome	6	\$248.80
	0366-N2	Drinking Fountain-Wallmount Slow-Close Push Handle 3/8-18 NPT Female Thread	Polished Chrome	6	\$152.00
	0366-N2HX8WB	Drinking Fountain-Wallmount Slow-Close Push Handle Brass Round Bowl, Brushed Finish 3/8-18 NPT Female Thread W/Wall Bracket	Polished Chrome	6	\$285.50
Suffix #	V	Vandal-Resistant Cap		---	\$3.30



DRINKING FAUCETS // Bubblers Heads

DRINKING FAUCET / BUBBLER HEADS





	Model#	Description	Finish	Case	Price
	0376	Drinking Faucet-Head 3/8-18 NPS Female Thread Less Stream Control	Polished Chrome	12	\$37.00
	0377	Drinking Faucet-Head 3/8-18 NPS Female Thread With Stream Control	Polished Chrome	12	\$61.80
	0425	Gravity Faucet Push Button 3/8-18 NPS Male Thread	Polished Chrome	40	\$28.60
	0426	Gravity Faucet Push Button 3/8-18 NPS Female Thread	Polished Chrome	40	\$21.90

WALLMOUNTS // Self-Closing Faucets

SELF-CLOSING WALLMOUNTS & STOPS

	Model#	Description	Finish	Case	Price
	0033-1/2CV-02	Self-Close Wallmount Faucet 4-Arm Vandal Proof Handle Plain End	Polished Chrome	6	\$110.00
	0033-1/2PV-02	1/2-14 NPT Female Thread Replaceable Seat	Polished Chrome	6	\$110.00
	0033-1/2HV-02	1-Hole Wallmount Solid Flange	Polished Chrome	6	\$110.00
	0031-H1/2C	Self-Close Wallmount Faucet 4-Arm Handle	Rough Chrome	6	\$80.20
	0031-H1/2P	Hose Thread	Rough Chrome	6	\$80.20
	0031-H1/2H	1/2-14 NPT Male Thread Replaceable Seat 1-Hole Wallmount	Rough Chrome	6	\$80.20

WALLMOUNT SINGLE HANDLE FAUCETS

	Model#	Description	Finish	Case	Price
	0005-H1/2P	Single Handle Wallmount Faucet 4-Arm Handle Hose Thread 1/2-14 NPT Female Thread Replaceable Seat 1-Hole Wallmount Adjustable Flange	Polished Chrome	6	\$60.50
	0006-H1/2C	Single Handle Wallmount Faucet Lever Handle	Rough Chrome	6	\$44.00
	0006-H1/2H	Hose Thread 1/2-14 NPT Male Thread Replaceable Seat 1-Hole Wallmount Adjustable Flange	Rough Chrome	6	\$44.00
	0007-1/2	Single Handle Wallmount Faucet 4-Arm Handle Plain End 1/2-14 NPT Female Thread Replaceable Seat 1-Hole Wallmount Solid Flange	Polished Chrome	6	\$52.50
	0007-H1/2	Single Handle Wallmount Faucet 4-Arm Handle Hose Thread 1/2-14 NPT Female Thread Replaceable Seat 1-Hole Wallmount Solid Flange	Polished Chrome	6	\$55.00

WALLMOUNTS



WALLMOUNTS // Self-closing Faucets

SELF-CLOSING WALLMOUNTS & STOPS

	Model#	Description	Finish	Case	Price
	0331-3/8	Self-Close Straight Stop 4-Arm Handle 3/8-18 NPS Female Thread Replaceable Seat	Polished Chrome	6	\$68.00
	0331-1/2	Self-Close Straight Stop 4-Arm Handle 1/2-14 NPS Female Thread Replaceable Seat	Polished Chrome	6	\$69.40
	0331-L3/8	Self-Close Straight Stop Lever Handle 3/8-18 NPS Female Thread Replaceable Seat	Polished Chrome	6	\$70.00
	0331-L1/2	Self-Close Straight Stop Lever Handle 1/2-14 NPS Female Thread Replaceable Seat	Polished Chrome	6	\$71.00
	0333-3/8	Self-Close Angle Stop 4-Arm Handle 3/8-18 NPS Female Thread Replaceable Seat	Polished Chrome	6	\$70.90
	0333-1/2	Self-Close Angle Stop 4-Arm Handle 1/2-14 NPS Female Thread Replaceable Seat	Polished Chrome	6	\$71.90
	0333-L3/8	Self-Close Angle Stop Lever Handle 3/8-18 NPS Female Thread Replaceable Seat	Polished Chrome	6	\$72.90
	0333-L1/2	Self-Close Angle Stop Lever Handle 1/2-14 NPS Female Thread Replaceable Seat	Polished Chrome	6	\$73.50
Suffix #	V	Vandal-Resistant Cap		---	\$3.30
	 0336-N2-3/8	Slow-Close Straight Stop Push Handle 3/8-18 NPS Female Thread (External Cycle Adjustment on Handle) Note: New ADA Compliant Cartridge and Handle Kit (CS-49016C,H,P) Fits Old Slow Close Faucets.	Polished Chrome	6	\$77.50
	0336-N2-1/2	Slow-Close Straight Stop Push Handle 1/2-14 NPS Female Thread (External Cycle Adjustment on Handle) Note: New ADA Compliant Cartridge and Handle Kit (CS-49016C,H,P) Fits Old Slow Close Faucets.	Polished Chrome	6	\$79.50



SPECIALTY // Valves

SPECIALTY VALVES

	Model#	Description	Finish	Case	Price
	0555	Alliance Anti-Sweat Temperature Valve for Water Closet Tanks Cast Brass Body 3/8-18 NPT Male Taper Thread Check Valves	Rough Brass	36	\$44.50
	0555-D	Alliance Anti-Sweat Temperature Valve for Water Closet Tanks Cast Brass Body 3/8-18 NPT Male Taper Thread Check Valves With Drains	Rough Brass	36	\$47.50
	0607-C1/2	Tile Stop Valve 3-Point Handle	Polished Chrome	6	\$41.00
	0607-C3/4*	1/2" Direct Sweat Inlet/Outlet *3/4-Inch Direct Sweat Inlets	Polished Chrome	6	\$42.00





SPECIALTY // Lawn Faucets

SPECIALTY LAWN FAUCETS

	Model#	Description	Finish	Case	Price
	0575-1/2	Lawn Faucet Wheel Handle	Rough Brass	6	\$38.00
	0575-1/2CP	Cast Brass Body, Hose Thread 1/2-14 NPS Female Thread Flange	Polished Chrome	6	\$64.00
	0576-1/2	Lawn Faucet Loose Key Handle	Rough Brass	6	\$38.00
	0576-1/2CP	Cast Brass Body, Hose Thread 1/2-14 NPS Female Thread Lockshield Type Flange	Polished Chrome	6	\$64.00
	0576-3/4	Lawn Faucet Loose Key Handle Cast Brass Body, Hose Thread 3/4-14 NPS Female Thread Lockshield Type Flange	Rough Brass	6	\$38.00



SPECIALTY // Shampoo Faucets

SPECIALTY SHAMPOO FAUCETS

	Model#	Description	Finish	Case	Price
	 1130	Single Handle Shampoo Faucet Lever Handle Ceramic Disc Cartridge W/Temperature Limit Stop Back-flow Preventers Included 2-Hole 4" to 18" Installation Pull-out Dual Pattern Sprayhead W/60" Heavy Duty Rubber Hose Pull-out Dual Pattern Sprayhead 2.0 GPM Flow Rate	Polished Chrome	6	\$114.60
	 1131-B	Two Handle Shampoo Faucet Canopy Handles	Polished Chrome	6	\$78.50
	1132-B*	35 Degree Bottom Outlet Supply Tube 1/2-14 NPS Male Inlets x 1-7/8" Long Replaceable Seats 3-Hole 4" Installation *3-3/8-Inch Centers	Polished Chrome	6	\$88.50
	CS-45002	Pull Out Spray Head and Hose Kit for 1130 Pull-out Dual Pattern Sprayhead W/60" Heavy Duty Rubber Hose	Polished Chrome	1	\$40.50
	CS-45003	Hose Guide and Mounting Kit for 1130	Polished Chrome	1	\$15.50





ACCESSORIES

ACCESSORIES

	Model#	Description	Finish	Case	Price
	0342-3/8	Stand Pipe 3/8-18 NPT Male Thread Nut & Flange	Polished Chrome	6	\$19.50
	0342-1/2	Stand Pipe 1/2-14 NPT Male Thread Nut & Flange	Polished Chrome	6	\$20.00
	0342-1/2VB	Stand Pipe 1/2-14 NPT Male Thread Nut & Flange Vacuum Breaker Note: For use with 0331-1/2, 0333-1/2, and 0336-1/2	Polished Chrome	6	\$65.60
	1109	Brass Pop-Up Drain Assembly With Guide With Over-Flow Drain Upper & Lower Pull Rods	Polished Chrome	12	\$40.00
	1109-LG	Brass Pop-Up Drain Assembly Less Guide With Over-Flow Drain Upper & Lower Pull Rods	Polished Chrome	12	\$37.50
	1109-BP	Brass Pop-Up Drain Assembly With Guide Without Over-Flow Drain Upper & Lower Pull Rods	Polished Chrome	12	\$50.00
	1109-BPLG	Brass Pop-Up Drain Assembly Less Guide Without Over-Flow Drain Upper & Lower Pull Rods	Polished Chrome	12	\$46.00
PARTS	G-195-DST9	Ball Lever Rod Group for 1109	---	1	\$7.75
	3105	Vandal-Resistant Grid Drain With Over-Flow Drain 17-Gauge Tailpiece	Polished Chrome	10	\$22.00
	3105-BP	Vandal-Resistant Grid Drain Without Over-Flow Drain 17-Gauge Tailpiece	Polished Chrome	10	\$23.00

ACCESSORIES

ACCESSORIES

	Model#	Description	Finish	Case	Price
	3106	Vandal-Resistant Grid Drain Offset for Wheelchair Access 17-Gauge Tailpiece	Polished Chrome	10	\$44.00
	G-1748-88W	Swivel Spout Adapter Allows for Topmount Faucets to be Mounted on Splash Back	Polished Chrome	10	\$14.60
	SU-2775-R-02	Double-Joint Swing Spout 7" C to C Heavy Cast Brass Construction Ideal for Three Compartment Sinks	Polished Chrome	10	\$42.00
	0112-AL	Overflow Socket Drain 1-11 1/2 NPS Shank X 1-7/8" Long	Polished Chrome	36	\$19.00

2019 CENTRAL BRASS SPOUTS & HANDLES CHARTS

CHARTS // Spouts

KITCHEN / LAVATORY HANDLE CONFIGURATION OPTIONS

SU-363-RA

8" Swivel Tube Spout with Aerator

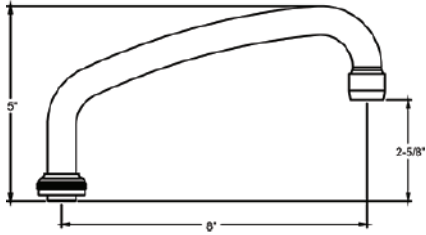

SU-363-JA

10" Swivel Tube Spout with Aerator

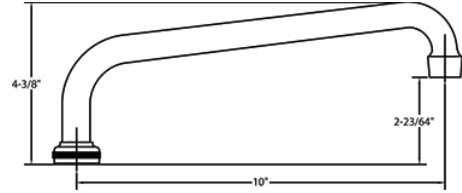

SU-363-LA

12" Swivel Tube Spout with Aerator

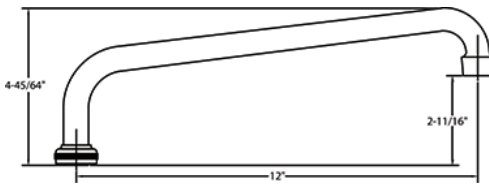

SU-363-MA

14" Swivel Tube Spout with Aerator

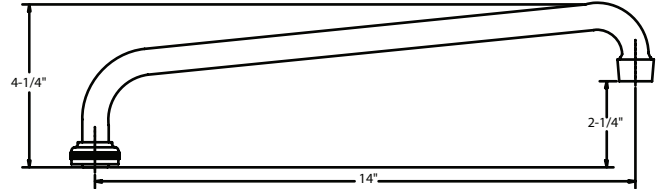

CS-22004

16" Swivel Tube Spout With Aerator

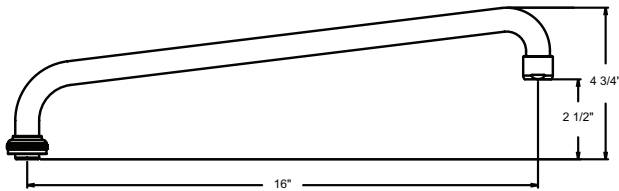

CS-22005

18" Swivel Tube Spout With Aerator

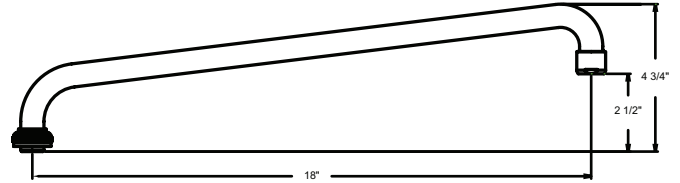

SU-2929-01

6" Hose End Cast Swivel Spout

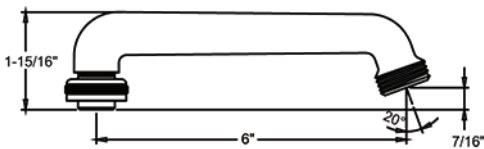

SU-365-CA

8" Brass Swivel "D" Spout with Aerator

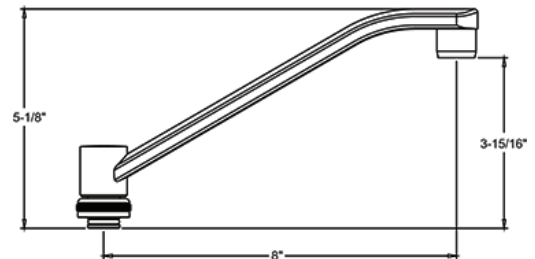

CHART

CHARTS // Spouts

KITCHEN / LAVATORY HANDLE CONFIGURATION OPTIONS

SU-2923-A

5" Cast Brass Swivel Spout with Aerator

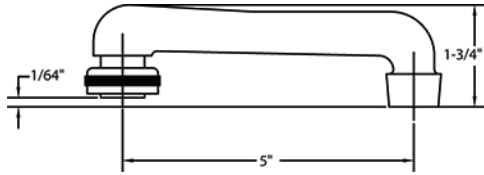

SU-2775-R-02

7" Cast Brass Spout Extension Polished Chrome

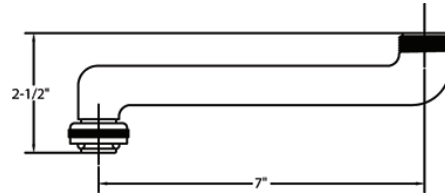

SU-2924-A

6" Tube Spout with Aerator

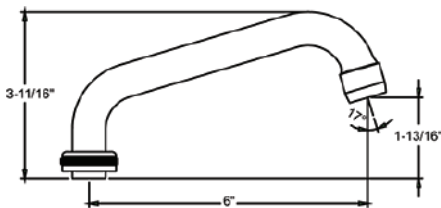

SU-157-GRA

4-3/32" Rigid Gooseneck Spout with Aerator

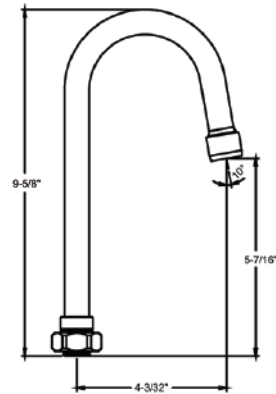

SU-157-GSA

4-3/32" Swivel Gooseneck Spout with Aerator

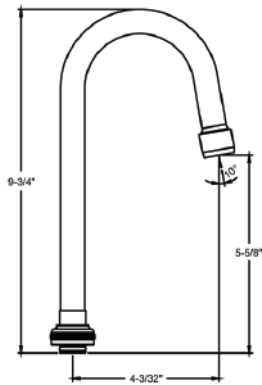

CS-25001 (GSA1)

4-3/32" Swivel Gooseneck Spout with Aerator

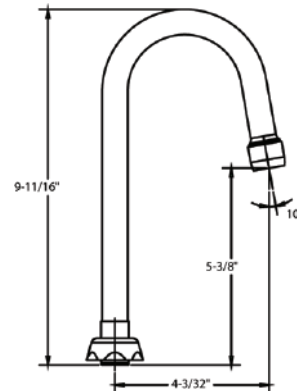

CHARTS // Spouts

KITCHEN / LAVATORY HANDLE CONFIGURATION OPTIONS

CS-22002

4-3/32" Combo Rigid/Swivel Gooseneck Spout With Aerator

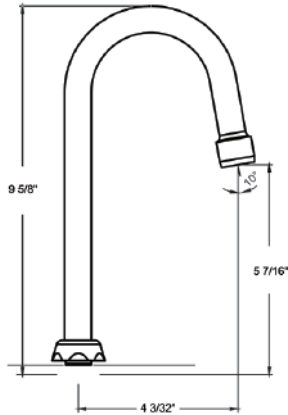

CS-22003

5-1/2" Combo Rigid/Swivel Gooseneck Spout With Aerator

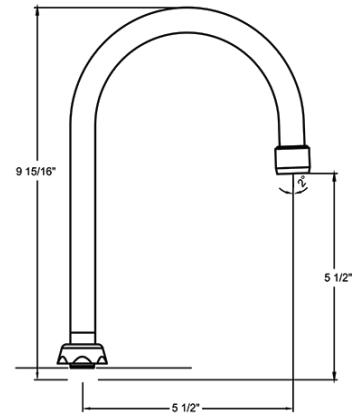

SU-157-KRA

5-1/2" Rigid Gooseneck Spout with Aerator

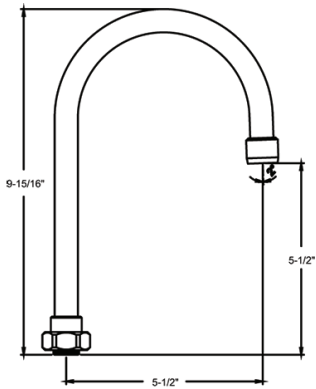

SU-157-KSA

5-1/2" Swivel Gooseneck Spout with Aerator

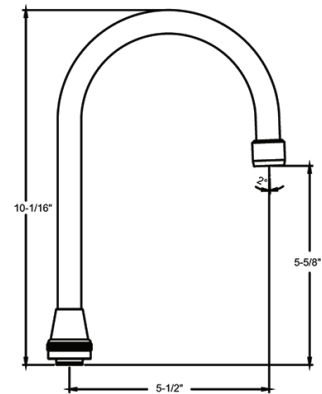

SU-257-TSA

6-3/8" Swivel Tri-Arc Gooseneck Spout with Aerator

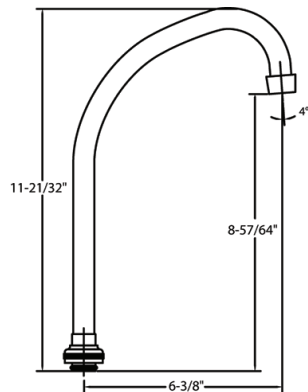

CS-22001 (TSA1)

6-3/8" Swivel Tri-Arc Gooseneck Spout with Aerator

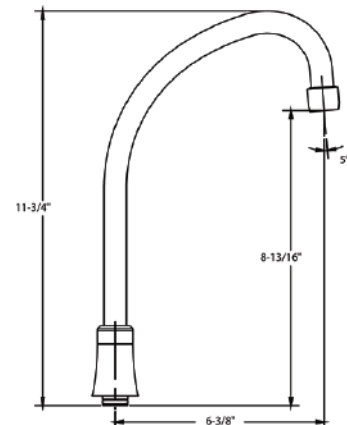

CHART

CHARTS // Spouts

KITCHEN / LAVATORY HANDLE CONFIGURATION OPTIONS

SU-357-HSA

7-1/4" Swivel High Rise Spout with Aerator

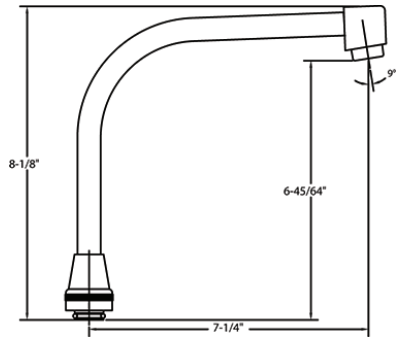

SU-357-WSA

8-3/4" Swivel Gooseneck Spout with Aerator

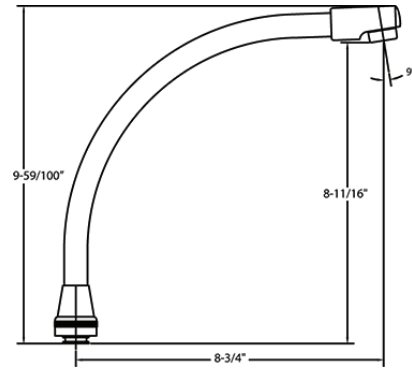

CHARTS // Handles

KITCHEN / LAVATORY HANDLE CONFIGURATION OPTIONS

K-512-02
K-512-15



G-518-C
G-518-H



G-523-C
G-523-H



G-4147-C
G-4147-H



G-4149-C
G-4149-H



G-398-C
G-398-H



CS-19003C
CS-19003H



CS-19004C
CS-19004H



CS-19001C
CS-19001H



CS-19002C
CS-19002H



CS-19007C
CS-19007H



SELF CLOSE / METERING HANDLE CONFIGURATION OPTIONS

G-7116-V*



PF-7114-P*



G-6928-V*



PF-7114-PS*



*Cap Sold Separately

CHARTS // Handles

SINGLE BASIN HANDLE CONFIGURATION OPTIONS

G-520-W

G-1043

CS-13001C
CS-13001P
CS-13001H



TUB & SHOWER HANDLE CONFIGURATION OPTIONS

G-521-BWC*
G-521-BWD*
G-521-BWH*

CS-14002C
CS-14002P
CS-14002H

CS-14001C
CS-14001P
CS-14001H

G-508-C*
G-508-H*
G-508-D*



*Escutcheons Sold Separately

PARTS

Part#	Where Used	PCS/ CS	Price
Replacement For Compression Units Only			
 K-454-C K-454-H	Stem Assembly w/ Replaceable Seat For Topmounts, Centersets, Wall Mounts, Utility Shower, Bar and Laundry Faucets-Cold, Hot	1	\$11.00
 G-454-EL G-454-ER	Stem Assembly For Topmounts, Centersets, Wall Mounts, Utility Shower, Bar and Laundry Faucets-Cold, Hot	1	\$9.50
 CS-39005C CS-39005H	Quick Pression 1/4 Turn Stem Assembly W/Check Valve- Cold, Hot	1	\$11.00
 G-458-KL G-458-KR	Stem Assembly For Shelf/ Slant Back Faucets-Cold, Hot	1	\$17.20
 SU-1548- 605	Stem Assembly For Tile Stop Valve (0607)	1	\$21.50
 SU-1839-P	Stem Assembly For Lawn Faucet (0575, 0576)	1	\$21.50
 SU-1839- PRC	Stem Assembly For Lawn Faucet (0575CP/RC, 0576CP/RC)	1	\$23.10
 SU-1855- 47RPRC	Stem Assembly For Single Hole Wallmount Faucets (0005,0006,0007,0009)	1	\$13.00
 XSU- 1858-A	Stem Assembly For Single Basin Faucet (0239)-2/pk	2	\$22.50
 K-2-CT	Stem Assembly W/Replace- able Seat For Washer Ma- chine Filler & Single By-Pass & Shower Corner Valve	1	\$32.00
 K-2-DT	Diverter Stem Assembly W/ Replaceable Seat For Old Style Three Handle Tub/ Shower Valve	1	\$57.10
 K-3-CT	Stem Assembly W/Replace- able Seat For Two & Three Handle Tub/Shower Valve	1	\$20.50
 K-3-DT	Diverter Stem Assembly W/ Replaceable Seat For Three Handle Tub/Shower Valve	1	\$21.00
Replacement For 0360,0361,0362			
 K-361	Stem Assembly For Drinking Faucets (0360, 0361, 0362)	1	\$40.60

Part#	Where Used	PCS/ CS	Price
Replacement For Ceramic Units Only			
 K-352-C K-352-H	Ceramic Stem Assembly For Topmounts, Centersets, Wall Mounts, Utility Shower, Bar and Laundry Faucets-Cold, Hot	1	\$30.50
 CS-39001	Ceramic Disc Cartridge For Single Handle Shampoo Faucet (1130)	1	\$9.50
 K-351-C K-351-H	Ceramic Stem Assembly For Two & Three Handle Tub/Shower Valve-Cold, Hot	1	\$39.50
 CS-34001C CS-34001H	Ceramic Stem Assembly For Two & Three Handle Tub/ Shower Valve-Cold, Hot (C3 & L3 Suffix)	1	\$27.00
 CS-34001V	Diverter Stem Assembly W/ Replaceable Seat For Three Handle Tub/Shower Valve (C3 & L3 Suffix)	1	\$21.50
Replacement For Metering (Slow-Close) Units Only			
 CS-49016C CS-49016H	Metering (Slow-Close) Car- tridge W/Cold / Hot Handle For Old Or New Metering (Slow-Close) Faucets	1	\$37.00
 CS-49016P	Metering (Slow-Close) Car- tridge W/Plain Handle For Old Or New Metering (Slow-Close) Faucets	1	\$37.00
 CS-49017C CS-49017H	Metering (Slow-Close) Cartridge W/Cold / Hot Handle For Old Or New Wide- spread Metering (Slow-Close) Faucets	1	\$36.50
 CS-39004	Metering (Slow-Close) Cartridge For New Metering (Slow-Close) Faucets (N2 & N1 Suffix)	1	\$33.00
Replacement For Self-Close Units Only			
 CS-39002	Self-Closing Stem Assembly For Drinking, Wallmounts/ Stops Faucets	1	\$49.50
 CS-39003	Self-Closing Stem Assembly For Lavatory (1167), Wall- mounts/Stops (0031, 0033) Faucets	1	\$66.50

PARTS

Part #	Description	PCS/ CS	List Price
X3	Brass Washer-6/pk	6	\$4.00
X4	Brass Packing Washer -6/pk	6	\$4.00
X4-L	Brass Packing Washer-6/pk	6	\$2.00
X4-MA	Nylon Washer-6/pk	6	\$2.00
X4-N	Celcon Washer for Diverter Stem-6/pk	6	\$1.50
G-21	Rod & Knob with Cotter Pins	1	\$9.50
X22	Brass Washer-6/pk	6	\$2.00
X28-A	Brass Washer for Widespread Spout with Hole for Pop-Up Pull Rod-6/pk	6	\$2.25
G-29-A	Flush Valve Group	1	\$15.10
CS-49032	2 Combo Union Nuts & Sleeve	1	\$14.00
G-30-C	2 Copper Union Nuts & 2 Sleeves	1	\$13.50
X33-A	Brass Washer-6/pk	6	\$2.00
X42	Klingersil Gasket-6/pk	6	\$3.50
X53-AS	Zinc Die Cast Locknut-6/pk	6	\$7.00
X53-AZ	Zinc Locknut for Shelf/Slant Back Lavatory Faucet-6/pk	6	\$6.90
X53-CZ	Zinc Die Cast Locknut-6/pk	6	\$7.50
X54	Thinner Crowfoot Steel Washer-10/pk	10	\$3.00
XPF-59	Brass Seat RC-10/pk	10	\$13.00
61-LC	Linkage (5-3/8")	1	\$3.50
SU-61-LC	5-3/8" Linkage	1	\$8.00
SU-61-LCPP	5-3/8" Linkage with Plunger for 1555	1	\$17.00
SU-61-LDP	6-3/16" Linkage with Plunger for 1655/1655X	1	\$32.00
SU-61-LEP	Linkage for 1655-X1817 Bath Drain	1	\$31.50
61-LU	Clevis	1	\$2.50
XPF-67-AC	Celcon Samson Nut for Self-Closing Handles-10/pk	10	\$5.00
X68-HX	Brass Square Nut for Slow-Close & Self-Closing Handles-10/pk	10	\$8.00
X69-C	Celcon Sleeve for Slow-Close & Self-Closing Handles-10/pk	10	\$3.00
X70-WA	Brass Hole Button for Items Without Pop-Up Drain-6/pk	6	\$6.25
X71	Brass Ball Retainer-2/pk	2	\$13.50
X82-J	Brass Packing Washer for Stem Assembly-6/pk	6	\$2.00
G-83-ACZ*	Faceplate For Lift & Turn or Chain With Stopper Bath Drains	1	\$10.00
G-83-AZ	Faceplate For Trip Lever or Pop-Up Bath Drains	1	\$22.00
SU-83-AZ	Trip Lever Face Plate	1	\$15.80
SU-85-APF	Rocker Arm Assembly with Flat Platform End	1	\$12.00
SU-85-FA	8-3/4" Linkage with Spring for 1676 Series	1	\$15.00
85-FW	Steel Wrench	1	\$1.00

*Will be obsolete when present stock is depleted

Part #	Description	PCS/ CS	List Price
SU-85-K	13-3/4" Linkage with Spring for 1675 Series	1	\$13.00
SU-85-KM	6-1/2" Linkage with Spring for 1674 Series	1	\$14.00
X85-U	2-11/16" Brass Eyebolt for Bath Drain Linkage & Plumber Groups-2/pk	2	\$2.00
SU-85-U	Clevis Assembly	1	\$5.50
G-94-F	Knob & Screw for Lift & Turn Bath Drains	1	\$2.50
G-95-A	Coupling Nuts & Washer (1 Set) (Thinner Crowfoot Washer)	1	\$3.00
G-97	Locknut Group-2/pk	1	\$3.00
X103-HS	Set Screw 3/16" Long 10-32-6/pk	6	\$2.00
X103-HSSS	Set Screw 1/18" Long-6/pk	6	\$2.00
X103-PLCP	Flat Head Knob Screw Phillips-6/pk	6	\$3.00
X104	Round Head Seat Washer Screw-25/pk	25	\$3.00
X105	Round Head Seat Washer Screw Slotted-25/pk	25	\$3.00
X105-H	Round Head Screw Slotted-6/pk	6	\$3.00
X107-F	Oval Head Handle Screw Phillips-25/pk	25	\$4.50
X107-FB	Color Code Index Ring-Blue-5/pk	5	\$3.00
X107-FR	Color Code Index Ring-Red-5/pk	5	\$3.00
X107-H	Oval Head Screw for 398/518 Handle Phillips-6/pk	6	\$3.00
X113-P	Hex Head Pop-Up Bracket Screw-6/pk	6	\$1.00
X126-S	Truss Head Screw-6/pk	6	\$0.75
X127-AP21/4	Face Plate Screw for Bath Drain Phillips-6/pk	6	\$6.50
G-128-52	Screw	2	\$2.00
SU-157-DA	4-3/16" Rigid Gooseneck Spout W/ Aerator	1	\$45.20
SU-157-GRA	4-1/16" Rigid Gooseneck Spout With Aerator	1	\$37.50
SU-157-GLA	3-15/16" Rigid Gooseneck Spout With Aerator for Bar Faucet (For 0289)	1	\$54.50
SU-157-GSA	4-1/16" Swivel Gooseneck Spout With Aerator	1	\$37.00
SU-157-G	3-15/16" Gooseneck Spout With Streamformer for Leg Tub Faucet	1	\$46.50
SU-157-HA	4-11/16" Rigid Gooseneck Spout With Aerator	1	\$59.00
157-I	Riser, Galvanized Gooseneck	1	\$31.50
SU-157-JA	4-15/16" Rigid Gooseneck Spout With Aerator	1	\$63.20
SU-157-KRA	5-9/16" Rigid Gooseneck Spout With Aerator	1	\$83.50
SU-157-KSA	5-9/16" Swivel Gooseneck Spout With Aerator	1	\$84.00
PF-161-D	Flange for Bubbler Head	1	\$8.10

Note: Order by Number of Packs Required, Not by Individual Pieces

PARTS

Part #	Description	PCS/ CS	List Price
X165	Brass Seat for Wash Machine Filler & Single By-pass Shower Valve-10/pk	10	\$13.00
X165-6500	Brass Seat-2/pk	2	\$5.00
X166-FN	Snap Ring for Spout-6/pk	6	\$1.00
X166-Q	Snap Ring for CentraLift Bath Drain-6/pk	6	\$2.00
XPF-166-U	Spout End Aerator Adapter-2/pk	2	\$7.00
X168-B	Hex Nut-4/pk	4	\$3.00
PF-177-G	Hose Push on Spout for Leg Tub Faucet	1	\$8.70
X193-LBN	Nylon Gasket for Shelf/Slant Back Stem Assembly-6/pk	6	\$1.50
X194	Cotter Pin For Shelf/Slant Back Faucets Rocker Arm Assembly-6/pk	6	\$1.00
X195-C	Clip for Pop-Up Pull Rod-6/pk	6	\$2.00
X207-B	Brass Hex Nut for Bath Drain-6/pk	6	\$2.50
PF-218-A	Brass Strainer Body for 1555 1655 1685	1	\$12.00
G-218-A	Strainer Group for Item Nos. 1555 & 1655	1	\$14.00
X218-B	Strainer Plate for 1555/1655-10/pk	10	\$6.50
X218-C	Oval Head Brass Strainer Plate Screw-10/pk	10	\$4.00
X218-F	Strainer Plate for 1665-X-2/pk	2	\$6.50
X222-D	Cotter Pin for Trip Lever Face Plater-6/pk	6	\$2.00
XSU-233-B	Chain & Ring for 0335-1/2 Self-Closing Shower Stop-2/pk	2	\$12.10
SU-257-JSA	6-3/8" Triple Radius Spout W/Aerator Must Use W/PF-1012-J Escutcheon	1	\$131.70
SU-257-TSA	6-3/8" Swivel Tri-Arc Gooseneck Spout With Aerator	1	\$92.00
PF-259-X	Brass Soap Dish	1	\$14.00
XPF-263-B	Brass Seat CP-4/pk	4	\$5.00
X263-BC	Seat-10/pk	10	\$13.50
XPF-263-C	Brass Seat RC-2/pk	2	\$6.00
PF-263-D	Seat for Widespread Series	1	\$9.70
SU-266-P	Diverter Piston-Plastic	1	\$5.50
268-TVR	Set-Diverter Piston	1	\$3.00
X269-29/16	2-9/16" Brass Nipple-10/pk	10	\$29.50
X279-D	Brass Washer-10/pk	10	\$2.50
X279-E	Brass Washer-10/pk	10	\$4.00
X279-L	Brass Washer-10/pk	10	\$1.75
X279-V	Spring-10/pk	10	\$3.00
G-284	Locknut & Washer Group	1	\$11.50
312-10N	10" Hose Connector	1	\$15.50
SU-357-HSA	7-1/4" Swivel High Rise Spout With Aerator	1	\$115.00
SU-357-WSA	8-3/4" Swivel Gooseneck Spout With Aerator	1	\$106.00
PF-358-Q	Cap Button for Bubbler Head	1	\$4.00

*Will be obsolete when present stock is depleted

Part #	Description	PCS/ CS	List Price
PF-358-RS	Cap Nut for Bubbler Head	1	\$9.50
SU-358-SA	Jet Assembly for Bubbler Head	1	\$9.00
X358-U	Fiber Washer-10/pk	10	\$1.50
X358-V	Monel Screen-10/pk	10	\$4.50
SU-363-JA	10" Swivel Tube Spout With Aerator	1	\$36.90
SU-363-JH	10" Swivel Tube Spout With Hose End	1	\$38.45
SU-363-LA	12" Swivel Tube Spout With Aerator	1	\$40.30
SU-363-LH	12" Swivel Tube Spout With Hose End	1	\$41.90
SU-363-MA	14" Swivel Tube Spout With Aerator	1	\$41.40
SU-363-MH	14" Swivel Tube Spout With Hose End	1	\$42.90
SU-363-RA	7-7/8" Swivel Tube Spout With Aerator	1	\$28.70
SU-363-RH	7-7/8" Swivel Tube Spout With Hose End	1	\$30.30
SU-365-CA	8-3/16" Swivel D Style Spout With Aerator	1	\$51.50
SU-365-CH	8-3/16" Swivel D Style Spout With Hose End	1	\$53.50
390	Flange	1	\$7.00
G-392	Brass Cover Plate with Gasket for Item No. 0094	1	\$18.50
PF-398-B8	Brass Bowl for Drinking Fountain	1	\$87.00
G-398-C	Round Fluted Handle With Screw - Cold	1	\$8.00
G-398-H	Round Fluted Handle With Screw - Hot	1	\$8.00
X402-A	Fiber Washer for Stem-25/pk	25	\$2.00
X402-B	Nylon Washer for Self-Closing Stem Assembly-12/pk	12	\$4.00
X409-PT	Ball Lever Packing for Pop-Up-12/pack	12	\$4.00
X420-N	Nylon Washer-12/pk	12	\$2.00
X427-WS	Gasket for Widespread Spout with Hole for Pop-Up Pull Rod-12/pk	12	\$7.00
X433-AN	Nylon Gasket for Self-Closing Stem Assembly-12/pk	12	\$6.00
X491-S	Klingersil Gasket-12/pk	12	\$10.50
X491-U	Klingersil Gasket-12/pk	12	\$7.50
G-508-C	Large Canopy Handle With Screw-Cold	1	\$11.00
G-508-H	Large Canopy Handle With Screw-Hot	1	\$11.00
G-508-D	Large Canopy Handle With Screw-Diverter	1	\$11.00
510	Escutcheon for Item No. 1177	1	\$7.10
SU-511-A	1-11/16" Shelf Back Spout With Aerator	1	\$28.70
G-518-C	Tear Drop Handle With Screw-Cold	1	\$16.50
G-518-H	Tear Drop Handle With Screw-Hot	1	\$16.50
G-520-W	Lever Laundry Faucet Handles Cold & Hot With Screws	1	\$4.95
521-B	Escutcheon	1	\$8.40
G-521-BWD*	3-Point Lever Handle With Screw-Diverter	1	\$8.40
G-523-C	Canopy Handle With Screw-Cold	1	\$6.00

Note: Order by Number of Packs Required, Not by Individual Pieces

PARTS

Part #	Description	PCS/ CS	List Price
G-523-H	Canopy Handle With Screw-Hot	1	\$6.00
524-B	Escutcheon for Ledge Fittings	1	\$6.00
530	Escutcheon for Ledge Fittings (High Skirt) for Slow-Close Handle Use	1	\$5.50
X700-KT	Brass Nipple for Item 0425 Push Button Gravity Faucet Only-2/pk	2	\$14.10
PF-714-RT	Brass Shower Riser 22-1/2" for Exposed Shower	1	\$154.70
714-WT-02	Shower Arm 6"	1	\$9.50
PF-725-A	4" Gooseneck Spout for Leg Tub Faucet	1	\$50.00
PF-731-G	3" Tailpiece for Bath Drain	1	\$9.50
731-K	Tailpiece Bent 90° for 1645-S & 1675-S	1	\$23.50
PF-741-DO	Spout Adapter for Bar Faucet	1	\$8.00
PF-752-T	2-1/2" Gooseneck Spout for Glass Filler	1	\$36.00
SU-756-CB	Post with Pin for Bath Drain	1	\$5.00
G-756-E	Regulator Stem With Washer for Restaurant Glass Filler (For 0323)	1	\$2.50
X765-TA	Brass Hex Packing Nut for Stem Assembly-6/pk	6	\$9.00
SU-767	Supply Tube for Bar Faucet	1	\$15.20
PF-768-D	Bubbler Cap for Drinking Fountain	1	\$8.00
PF-776-D	Bubbler Shank for Drinking Fountain	1	\$10.50
781-A	Shank	1	\$15.00
XPF-782-D	Brass Spout Nut RC-2/pk	2	\$6.00
XPF-784-C	Spout Hose End Adapter CP-2/pk	2	\$6.00
X809	Packing #52AFT Material-10/pk	10	\$2.50
X814-BARP	Rubber Packing-10/pk	10	\$10.00
X848-B	Felt Packing-10/pk	10	\$3.50
X901-WNN	Seat Washer-25/pk	25	\$3.50
X904-N	Buna Seat Washer for Self-Closing Stem Assembly -6/pk	6	\$1.65
X913-N	Acrylonitrile Seat Washer-10/pk	10	\$2.00
G-913-A	Coupling Nuts & Washers (2 Sets) (Thinner Crowfoot Washer)	1	\$6.50
G-914-SA	Coupling Nuts & Washers (2 Sets) (Thicker Crowfoot Washer)	1	\$7.00
X936-A	Rubber Washer for Stand Pipe-6/pk	6	\$4.50
X940	Rubber Washer for Bubbler Head-10/pk	10	\$3.00
X940-TRN	Santoprene Washer-10/pk	10	\$3.50
X944-N	Santoprene Washer-2/pk	2	\$1.50
X945	Rubber Seat Washer-2/pk	2	\$3.50
X947-C	Rubber Washer-10/pk	10	\$4.00
X954-AN	Slip Joint Rubber Washer-10/pk	10	\$2.00
X977	Packing-10/pk	10	\$4.50
990-L	Sponge Washer	1	\$5.00
X991	Rubber Washer for Centralift Lift & Turn Bath Drain-4/pk	4	\$3.00

Part #	Description	PCS/ CS	List Price
X991-A	Rubber Washer-4/pk	4	\$7.00
X991-C	Rubber Washer for Trip Lever Bath Drain-4/pk	4	\$3.50
1008-B	Stainless Steel Spring	1	\$2.50
X1009-A	Spring for Self-Closing Stem Assembly -2/pk	2	\$12.00
1011-N	Escutcheon	1	\$7.50
1012-N	Spout Escutcheon	1	\$9.00
X1028-Y	Nylon Gasket-25/pk	25	\$2.50
X1038-453	O-Ring for Stem Assembly-25/pk	25	\$4.00
X1038-IN	O-Ring for Shelf/Slant Back Lavatory Faucets Center Tee Use-10/pk	10	\$3.50
X1038-KN	O-Ring Epdm Rubber-25/pk	25	\$7.00
X1038-W	O-Ring Buna N-10/pk	10	\$4.00
G-1043	4-Arm Handle W/Screw-Plain	1	\$10.10
X1043-B	Brass Washer-6/pk	6	\$4.00
PF-1043-A	Push Button Cap for Glass Filler	1	\$3.50
G-1043-C	Cylinder Sub-Unit with Gasket	1	\$26.60
X1043-FN	Nylon Washer-2/pk	2	\$1.50
SU-1043-S	Push Valve Stem With Diaphragm for Glass Filler	1	\$9.00
X1043-T	Brass Washer for Stand Pipe-6/pk	6	\$2.50
X1081-N	Brass Hex Nut-10/pk	10	\$2.00
PF-1090-J	Regulator Cap for Glass Filler (For 0323)	1	\$3.50
SU-1109	Pop-Up Drain Less Pull Rod Ball Lever Rod & Bracket	1	\$38.50
XSU-1548-BSP	Stem Assembly For Wash Machine Filler & Shower Valve-2/pk	2	\$36.50
G-1548-ET	Stem Extension with Screw	1	\$33.00
X1549	Stem Bonnet for Wash Machine Filler & Single By-pass Shower Valve-2/pk	2	\$19.50
G-1588-CT	Stem & Diverter Bonnet Grp (K-3-DT)	1	\$16.50
U-1615-50RC	2-1/2" Rigid Spout w/Hose End & Vacuum Breaker For 0050 Service Sink	1	\$110.30
U-1615-54-02	Rigid Spout W/Hose End & Vacuum Breaker Include Adjuster Rod & Pin	1	\$186.50
U-1615-54-04	Rigid Spout W/Hose End & Vacuum Breaker Include Adjuster Rod & Pin	1	\$139.00
G-1748-88W	Swivel Spout Adapter	1	\$14.60
XG-1867-ALCP	Wheel Handle with X126-S Screw Chrome Plated-2/pk	2	\$17.50
X1875	1/2" IP Union Inlets for Rough Brass Faucet Only-2/pk	2	\$6.00
X1875-C	1/2" Copper Sweat Union Inlets for Rough Brass Faucet Only-2/pk	2	\$6.00
X1876-BB	Coupling Nut for Rough Brass Faucet Only-2/pk	2	\$9.00

*Will be obsolete when present stock is depleted

Note: Order by Number of Packs Required, Not by Individual Pieces

PARTS

Part #	Description	PCS/ CS	List Price
SU-2051-P	Pull Rod Guide for 1104 & 1104-BP Pop-Up Drain Only	1	\$13.80
2056-SPT1109	Top Flange for 1109 Pop-up	1	\$5.00
G-2090-S	Spout Shank Trim Group	1	\$28.00
SU-2090-A	4-1/2" Blendo Widespread Spout With Aerator	1	\$123.00
SU-2090-AB	4-1/2" Blendo Widespread Spout With Aerator No Pull Rod Hole	1	\$122.50
G-2115-TP	Stopper for U-1109	1	\$7.50
2126-A	Rocker Arm for 1177	1	\$6.00
X2133-210	Brass Flange for Leg Tub Faucet-2/pk	2	\$49.20
SU-2136-FA	Slant Back Spout With Aerator (For 1178)	1	\$74.00
U-2170-AL	Hot Corner Body Valve Unit for Shelf Back Lavatory Faucet	1	\$61.50
U-2170-AR	Cold Corner Body Valve Unit for Shelf Back Lavatory Faucet	1	\$61.50
U-2171-A	6" Center Tee w/ Rocker Arm for Shelf Back/Slant Back Lavatory Faucet	1	\$38.00
SU-2775-R-02	Double-Joint Swing Spout	1	\$42.00
SU-2806	Female Flange Adjustable 6-1/2" to 9-1/2"	1	\$51.00
SU-2807	Female Flange Adjustable 7-7/8" to 8-1/8"	1	\$34.60
SU-2841-ARC	Female Flange Adjustable 3" to 13" With Integral Stops	1	\$82.00
SU-2841-S	Female Flange Adjustable 2-1/2" to 8-1/2"	1	\$108.00
SU-2846	Male Flange Adjustable 7-7/8" to 8-1/8"	1	\$38.70
G-2887	Wall Bracket with Nipples & Wood Screws	1	\$104.00
2985-J	Cast Brass Centerpiece	1	\$29.70
SU-2923-A	5" Cast Spout With Aerator	1	\$69.50
SU-2924-A	6-1/8" Swivel Tube Spout With Aerator	1	\$26.50
SU-2924-H-02	6-1/8" Swivel Tube Spout With Hose End Chrome Plated	1	\$26.50
SU-2924-H-01	6-1/8" Swivel Tube Spout With Hose End Rough Brass	1	\$21.50
SU-2929-01	6-1/4" Swivel Cast Brass Spout W/Hose End For Laundry Rough Brass	1	\$36.00
SU-2987-DA	Guide for Hose & Spray	1	\$7.50
X3008-X	Brass Coupling Nut-2/pk	2	\$6.00
G-3009-A	Strainer Group	1	\$34.00
SU-3026-B	Drain Shoe & Tube	1	\$41.00
SU-3026-CDL	Drain Shoe & Tube Without Strainer Body	1	\$23.50
G-3036-A	Centralift Strainer Group	1	\$61.35
3034-1/2-02	Shower Head with Brass Shower Ball	1	\$17.90
3042-A	Plunger for 1655	1	\$25.00
3042-P	Plunger for 1555	1	\$8.00

*Will be obsolete when present stock is depleted

Part #	Description	PCS/ CS	List Price
3061-AZ1/2	1/2" IPS & Slip-on Combo Diverter Tub Spout	1	\$25.00
G-3113-6	Shower Head, Arm (6") & Flanges	1	\$30.50
SU-3130-M	Wall Bracket Rod & Pin Group for Service Sink Faucet	1	\$61.00
G-3131	Wall Bracket Group	1	\$70.00
3145-D	Brass Overim Tub Spout, 1/2" I.P.S.	1	\$62.50
3154-Z	Zamak Overim Tub Spout, 1/2" I.P.S.	1	\$13.00
G-3359-A	Strainer Plug	1	\$14.50
PF-3359-A	Brass Drain Plug For Bath Drains	1	\$10.00
SU-3359-A	Strainer Plug assembly With Plug Guide & Rocker Arm for Bath Drain	1	\$31.50
3362	Strainer Plug Body	1	\$30.00
X4079-3/8	Brass Hex Locknut for Item 0425 Push Button Gravity Faucet Only-4/pk	1	\$11.50
G-4147-C	Wrist Handle (4") With Blue Index Ring & Screw-Cold	1	\$31.50
G-4147-H	Wrist Handle (4") With Red Index Ring & Screw-Hot	1	\$31.50
G-4149-C	Wrist Handle (6") With Blue Index Ring & Screw-Cold	1	\$34.00
G-4149-H	Wrist Handle (6") With Red Index Ring & Screw-Hot	1	\$34.00
PF-5075-YP	Nut for Stand Pipe	1	\$6.00
G-5355-S	Rod Adjuster & Pin Group	1	\$10.50
PF-6928-P	Self-Closing 4-Arm Handle	1	\$39.70
G-6928-V	Self-Closing 4-Arm Vandal Proof Handle With Set Screw	1	\$43.90
PF-6930	Hex Cap Nut for Glass Filler (For 0393)	1	\$18.90
SU-6965	Bubbler Body for 0364-L/0365-L/0366-L	1	\$68.00
SU-7071	Bubbler Body for 0366-HX8 & 0366-HX8WB	1	\$123.50
7074-L	Drain Plate Chrome Plated	1	\$18.50
SU-7101-AF	Self-Closing Stem Assembly	1	\$10.50
PF-7114-P	Self-Closing Lever Handle	1	\$41.10
PF-7114-PS	Self-Closing Lever Handle With Hole for Chain & Ring	1	\$45.30
G-7114-V	Self-Closing Lever Vandal Proof Handle With Screw	1	\$44.00
G-7116-V	Self-Closing Lever Vandal Proof Handle With Screw	1	\$43.50
PF-7125	Brass Cap for Self-Closing-Plain	1	\$9.60
PF-7125-C	Brass Cap for Self-Closing-Cold	1	\$9.60
PF-7125-H	Brass Cap for Self-Closing-Hot	1	\$9.60
X7133-AZ	Zinc Die Cast Locknut-10/pk	10	\$7.00
G-7233	Leg Mounting Group for Item 0468	1	\$35.00
G-7237	Leg Mounting Group for Item 0470	1	\$23.30
G-7237-477	Leg & Wall Bracket Group (For 0477)	1	\$34.50
7255-M	Loose Key	1	\$3.00

Note: Order by Number of Packs Required, Not by Individual Pieces

PARTS

Part #	Description	PCS/ CS	List Price
CS-13001C	Cross Handle-Cold	1	\$20.50
CS-13001H	Cross Handle-Hot	1	\$20.50
CS-13001P	Cross Handle-Plain	1	\$20.50
CS-13002C	Push Handle for 3127-Cold	1	\$14.40
CS-13002H	Push Handle for 3127-Hot	1	\$14.40
CS-13003P	Push Handle for 0355, 0356, 0336, 3137-Plain	1	\$5.40
CS-13004C	Stem Assembly W/Centerpiece & Lever Vandal Proof Handle-Cold	1	\$113.30
CS-13004H	Stem Assembly W/Centerpiece & Lever Vandal Proof Handle-Hot	1	\$113.30
CS-14001C	Lever Handle-Cold	1	\$45.00
CS-14001H	Lever Handle-Hot	1	\$45.00
CS-14001P	Lever Handle-Plain	1	\$45.00
CS-14002C	Cross Handle-Cold	1	\$52.00
CS-14002H	Cross Handle-Hot	1	\$52.00
CS-14002P	Cross Handle-Plain	1	\$52.00
CS-15001	Lever Handle	1	\$15.50
CS-19001C	Lever Handle-Cold	1	\$31.00
CS-19001H	Lever Handle-Hot	1	\$31.00
CS-19002C	Lever Handle-Cold	1	\$28.90
CS-19002H	Lever Handle-Hot	1	\$28.90
CS-19003C	Cross Handle-Cold	1	\$36.40
CS-19003H	Cross Handle-Hot	1	\$36.40
CS-19004C	Cross Handle-Cold	1	\$33.50
CS-19004H	Cross Handle-Hot	1	\$33.50
CS-19005	Stem Assembly W/Centerpiece & Lever Handle W/Cap-Plain	1	\$54.50
CS-19006	Stem Assembly W/Centerpiece & 4-Arm Handle W/Cap-Plain	1	\$53.40
CS-22001	6-1/4" Tri-Arc Gooseneck Swivel Spout W/Aerator	1	\$68.00
CS-22002	4-3/32" Combo Rigid/Swivel Gooseneck Spout With Aerator	1	\$37.50
CS-23002	C' Style Spout W/Aerator W/Pop-Up Hole	1	\$90.50
CS-25001	4-1/8" Gooseneck Swivel Spout W/ Aerator	1	\$32.50
CS-42001	Spout Escutcheon	1	\$33.50
CS-42002	Easy Install Adapter for Chicago Faucet to Central Brass	1	\$35.20
CS-42003	Easy Install Adapter for T & S Faucet to Central Brass	1	\$31.80
CS-42004	Easy Install Adapter for Fisher Faucet to Central Brass	1	\$39.80
CS-43001	Mechanical Mixing Valve	1	\$58.50
CS-43005	18" Long 1/4" X 1/2" Flex Hose Connector	1	\$9.50

Part #	Description	PCS/ CS	List Price
CS-43006	30" Long 3/8" X 1/2" Flex Hose Connector	1	\$9.50
CS-43007	Control Module Filter	1	\$3.00
CS-43008	Ball Lever Rod Group for Item Nos. 1177 & 1178	1	\$4.50
CS-43009	8" Center Tee w/ Rocker Arm for Shelf Back/Slant Back Lavatory Faucet	1	\$57.00
CS-44001	Valve Escutcheon	1	\$20.60
CS-44002	2-9/16" Cuttable Brass Nipple	1	\$4.00
CS-45002	Pull Out Spray Head and Hose Kit for 1130	1	\$40.50
CS-45003	Hose Guide and Mounting Kit for 1130	1	\$15.50
CS-46001	Strain Plate With Weep Holes	1	\$2.40
CS-47001	Check Valve	2	\$5.50
CS-48001	Drain Adapter 3/8" to 1-1/4"	1	\$19.00
CS-49003	Vandal Resistant 13/16"-27 Thread Male 0.5 GPM Spray Pattern Aerator	1	\$13.50
CS-49004	Vandal Resistant 55/64"-27 Thread Female 0.5 GPM Spray Pattern Aerator	1	\$12.50
CS-49005	Vandal Resistant 13/16"-27 Thread Male 1.0 GPM Aerator	1	\$9.00
CS-49007	Vandal Resistant 13/16"-27 Thread Male 1.5 GPM Aerator	1	\$8.00
CS-49008	Vandal Resistant 55/64"-27 Thread Female 1.5 GPM Aerator	1	\$6.50
CS-49009	13/16"-27 Thread Male 0.5 GPM Spray Pattern Aerator	1	\$10.50
CS-49011	13/16"-27 Thread Male 1.0 GPM Aerator	1	\$3.50
CS-49012	55/64"-27 Thread Female 1.0 GPM Aerator	1	\$4.00
CS-49013	13/16"-27 Thread Male 1.5 GPM Aerator	1	\$4.50
CS-49014	55/64"-27 Thread Female 1.5 GPM Aerator	1	\$3.50
CS-49015	13/16"-27 Male Thread Vandal Proof Laminar 1.5 GPM Aerator	1	\$6.50
CS-49018C	Handle Button-Cold	1	\$2.00
CS-49018H	Handle Button-Hot	1	\$2.00
CS-49019	Handle Screw	1	\$0.75
CS-49020	Teflon Gasket	1	\$2.00
CS-49026	POM Spring Support Packing	1	\$3.60
CS-49027	POM Spring Support Packing For 1167/ 0031/ 0033 Series	1	\$3.10
CS-53001	Mounting Kit for 2092	1	\$4.50
CS-53002	Mounting Kit for 2093, 2094	1	\$6.00
CS-53003	Mounting Tool for 2093, 2094	1	\$7.20
CS-53004	Mounting Kit for 2095	1	\$9.00
CS-63003	AC Power Adapter	1	\$36.00
CS-63004	Control Module	1	\$277.00
CS-63005	Brass Pop-up Drain Assembly	1	\$40.50

*Will be obsolete when present stock is depleted

Note: Order by Number of Packs Required, Not by Individual Pieces

PARTS

Part #	Description	PCS/ CS	List Price
XCS-44002	2-9/16" Cuttable Brass Nipple-10/pk	10	\$38.00
XCS-45004	Retaining Ring 2/Pk	2	\$5.00
XCS-45005	Retainer Nut 2/Pk	2	\$2.50
XCS-45006	Gasket 5/Pk	5	\$1.00
XCS-45007	O-Ring 5/Pk	5	\$1.00
XCS-49001	3/32" Allen Screw 10/Pk	10	\$1.00
XCS-49002	Red/Blue Indicator 10/Pk	10	\$2.00
XCS-53005	Mounting Screws for Control Module 4 Pairs	4	\$2.00
CS-49029	Full Flow Streamer (Female)	1	\$3.30
G-285-AZ	Brass Soap Dish	1	\$11.50
X1038-S	O-Ring-2/pk	2	\$1.20
X4015	Brass Coupling Nut-4/pk	1	\$5.50
XPF-460	Brass Cap Nut-2/pk	2	\$6.90

TERMS & CONDITIONS

PIONEER

PAYMENT TERMS

Net 30 days for all accounts in good standing. 1-1/2% per month interest on all past due balances. Should any invoice be held in question, the balance not in question must be paid within the previously mentioned terms.

ORDERS

Minimum orders \$100 net.

BACKORDERS

Backorders will be shipped unless otherwise notified by customer.

SALES TAX

All merchandise is sold to customers for resale. Customers assume full responsibility for all taxes or other assessments imposed by any government agency. All customers must furnish Pioneer a valid resale or tax exemption number.

RETURNS

Product MAY NOT be returned without prior inspection and written authorization from a Pioneer Industries Inc. sales representative. An approved Returned Goods Authorization must accompany all returns. A handling charge of 50% will be assessed against any returned product without prior authorization. Credits will be issued based on the established purchase price less any applicable transportation, handling and restocking charges. Returns of discontinued products or products in non-resalable condition are not accepted and will be issued credit at scrap value only. Credits must be taken within six months of date of issue.

CLAIMS

All claims for shortages must be made within 3 days of receipt of shipment. Pioneer shall be held blameless in any claim of injury during installation of Pioneer merchandise.

PRICES

Prices are subject to change without notice.

MODELS

Pioneer may, at its discretion, discontinue, modify or change any product listed in its catalog without prior notice.

FREIGHT

All goods are sold F.O.B. Commerce, California or F.O.B. Antioch, Tennessee. Freight will be prepaid on orders of \$1000 net or more to all 48 contiguous states. Prepaid orders from customers not within 48 contiguous states will be shipped prepaid to any port or border destination within the 48 contiguous states. We reserve the right to ship via the most cost effective route.

SALES POLICY

Possession of this catalog does not constitute an offer to sell.

DISCLAIMER

Any and all references to trade names and/or trademarks in this catalog shall not be construed to be an endorsement by such manufacturer.

TERMS & CONDITIONS

OLYMPIA

PAYMENT TERMS

Net 30 days for all accounts in good standing. 1-1/2% per month interest on all past due balances. Should any invoice be held in question, the balance not in question must be paid within the previously mentioned terms.

ORDERS

Minimum orders \$100 net.

BACKORDERS

Backorders will be shipped unless otherwise notified by customer.

SALES TAX

All merchandise is sold to customers for resale. Customers assume full responsibility for all taxes or other assessments imposed by any government agency. All customers must furnish Olympia Faucets a valid resale or tax exemption number.

RETURNS

Product MAY NOT be returned without prior inspection and written authorization from a Olympia Faucet, Inc. sales representative. An approved Returned Goods Authorization must accompany all returns. A handling charge of 50% will be assessed against any returned product without prior authorization. Credits will be issued based on the established purchase price less any applicable transportation, handling and restocking charges. Returns of discontinued products or products in non-resalable condition are not accepted and will be issued credit at scrap value only. Credits must be taken within six months of date of issue.

CLAIMS

All claims for shortages must be made within 3 days of receipt of shipment. Olympia shall be held blameless in any claim of injury during installation of Olympia merchandise.

PRICES

Prices are subject to change without notice.

MODELS

Olympia may, at its discretion, discontinue, modify or change any product listed in its catalog without prior notice.

FREIGHT

All goods are sold F.O.B. Commerce, California or F.O.B. Antioch, Tennessee. Freight will be prepaid on orders of \$1000 net or more to all 48 contiguous states. Prepaid orders from customers not within 48 contiguous states will be shipped prepaid to any port or border destination within the 48 contiguous states. We reserve the right to ship via the most cost effective route.

SALES POLICY

Possession of this catalog does not constitute an offer to sell.

DISCLAIMER

Any and all references to trade names and/or trademarks in this catalog shall not be construed to be an endorsement by such manufacturer.

TERMS & CONDITIONS

CENTRAL BRASS

This price book has been prepared for the convenience of Central Brass' distributors and their customers and supersedes all previous Central Brass price schedules. The prices shown are the basis for distributor discounts and are not intended as resale prices. Possession of this price book by any person is not an offer to sell them, or anyone else, the goods listed herein at the prices shown.

SALES TAX

All merchandise is sold to customers for resale. Customers assume full responsibility for all taxes or other assessments imposed by any government agency. All customers must furnish a valid resale or tax exemption number.

RETURNED GOODS

Product MAY NOT be returned without prior inspection and written authorization from a Central Brass representative. An approved Returned Goods Authorization must accompany all returns. A handling charge of 50% will be assessed against any returned product without prior authorization. Credits will be issued based on the established purchase price less any applicable transportation, handling and restocking charges. Returns of discontinued products or products determined to be in non-resalable condition are not accepted and will be issued credit at scrap value only. Credits must be taken within six months of date of issue.

CLAIMS

Claims for shortage of goods must be presented within 5 days from the date of receipt of shipment and must state the packing slip number applicable to the claim. Any claim not so presented will be conclusively deemed waived.

WARRANTY

Central Brass products are warranted to the original consumer purchaser. Please refer to the warranty enclosed with each Central Brass product for specific details. Additional copies are available upon request.

SALES POLICY

All prices within this catalog are subject to change without notice. Goods which differ in any material respect, such as size or finish, from the goods as illustrated and described in Seller's literature are subject to special prices. Central Brass may, at its discretion, discontinue, modify or change any product listed in its catalog without prior notice.



PIONEER INDUSTRIES

3325 S. Garfield Avenue
Commerce, CA 90040

Email: sales@pioneerind.com
Phone: 800.338.9468
Fax: 323.888.9515

pioneerind.com
olympiafaucets.com
centralbrass.com

LT-19-PPB-01